



Beta

Listino Prezzi

prezzi I.V.A. esclusa

€

71



2 14

www.beta-tools.it

 **Robur**

 **BetaWORK**

**Beta**
SHOP
in shop

**Beta**
Collection

Beta



BETA: LA STORIA DELL'UTENSILERIA ITALIANA

1923 - Alessandro Ciceri fonda la stamperia "Alessandro Ciceri & Figli", specializzata in stampi di ferro e acciaio.

1939 - Viene depositato il marchio Beta e l'Azienda si specializza nella produzione di utensili per uso professionale.

1960 - Beta Utensili conta duecento dipendenti, esporta i propri prodotti all'estero e si afferma quale realtà emergente nel settore dell'utensileria professionale.

1969 - Nasce il rivoluzionario carrello "Tank" in lamiera arancione; il colore che - da quel momento in poi - renderà inconfondibile lo stile del marchio Beta.

1971 - Beta Utensili entra nel mondo delle competizioni motoristiche intese come momento di verifica e sviluppo dei propri prodotti.

1975 - Arriva il primo grande successo in Formula 1 con la **March-Beta Utensili** di colore arancione di Vittorio Brambilla che vince il Gran Premio d'Austria nel diluvio di Zeltweg.

1980 - Aumenta la penetrazione nei più importanti mercati Europei con la costituzione progressiva di filiali Beta Utensili in Francia, Gran Bretagna, Olanda, Spagna e Polonia.

1995 - In soli 8 mesi l'Azienda ottiene la certificazione **Sistema di Qualità ISO 9001**.

2000 - La presentazione del nuovo catalogo Beta Utensili conferma il continuo processo di crescita. Raddoppia la gamma dei prodotti in offerta e le oltre 10000 referenze vengono suddivise in 20 famiglie di prodotto.

2002 - L'offerta Beta Utensili viene ulteriormente ampliata con l'introduzione della gamma di calzature antinfortunistiche e la linea di abbigliamento da lavoro e tempo libero "Beta Work".

2014 - Un ininterrotto percorso di crescita che conduce alla realtà odierna: un gamma prodotto - distribuita in tutto il mondo - che supera le 10.000 referenze e comprende articoli adatti a soddisfare le esigenze dei professionisti più esigenti.





2014

2009



1969



1995



2006

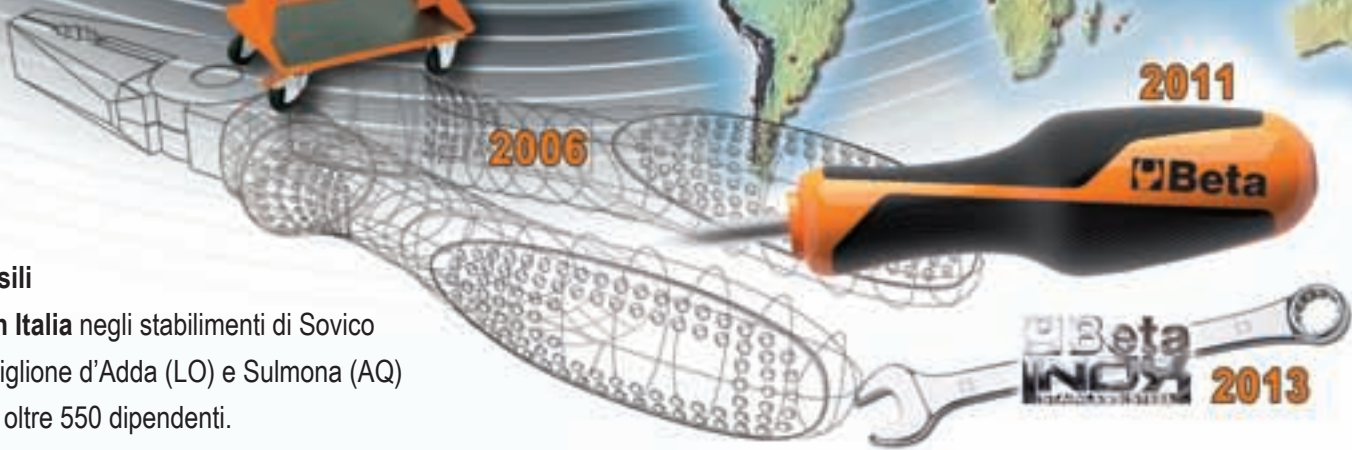

2011



Beta Utensili

produce in Italia negli stabilimenti di Sovico (MB), Castiglione d'Adda (LO) e Sulmona (AQ) e impegna oltre 550 dipendenti.

Beta Utensili rispetta l'ambiente dedicando particolare attenzione nella scelta di materiali e processi che garantiscano il minimo impatto sull'ecosistema.

Beta Utensili è presente nel Mondo grazie ad una performante struttura logistica e una capillare rete distributiva che comprende 7 filiali estere in Francia, Gran Bretagna, Olanda, Spagna, Polonia, Cina, Brasile e oltre 200 importatori e distributori.

Beta Utensili è leader per qualità grazie ai rigorosi controlli sui propri prodotti e sui processi di attività aziendale secondo quanto stabilito dalla normativa ISO 9001.

Beta Utensili vince da quarant'anni. Un legame indissolubile - corrisposto dai migliori professionisti impegnati nella conquista di risultati prestigiosi - sancito nel tempo da collaborazioni con team prestigiosi, come Ferrari, Jordan, McLaren e Minardi in Formula 1 e Honda, Suzuki, Kawasaki e Yamaha nel MotoGP.

BETA UTENSILI S.p.A. - 20845 Sovico (MB)
Via A. Volta, 18 - Tel. 039.2077.1 - Telefax 039.2010742
www.beta-tools.com - info@beta-tools.com

Sede produttiva Accessori per funi Robur: 67039 Sulmona (AQ)
Zona industriale - C.da S. Nicola - Tel. 0864.2504.1 - Telefax 0864.253132
www.roburitaly.com - info@roburitaly.com

Deposito di Milano: Via Ferrante Aporti, 26
Tel. 02.28040686 - Telefax 02.28040679



2013

CONTENITORI E ASSORTIMENTI



☐ 203÷248

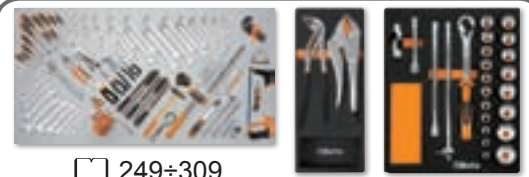

☐ 249÷309

CHIAVI DI MANOVRA



☐ 10÷15



☐ 20÷23



☐ 82÷86

CHIAVI A BUSSOLA E ACCESSORI



☐ 50÷56



☐ 62÷82

CHIAVI DINAMOMETRICHE E MOLTIPLICATORI



☐ 43÷44



☐ 44÷50

GIRAVITE, CHIAVI MASCHIO E INSERTI



☐ 16÷20



☐ 56÷62



☐ 85÷86



☐ 104÷114

PINZE E TRONCHESI



☐ 93÷97



☐ 92-93, 101-102



☐ 165

MARTELLI E SCALPELLI



☐ 9-10



☐ 117÷120



☐ 152

UTENSILI PER FORARE E FILETTARE

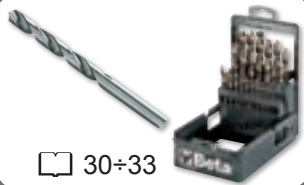

ESTRATTORI



UTENSILI PER MISURARE E TRACCIARE



UTENSILI PER TAGLIARE E MANUTENZIONI VARIE



IDRAULICA

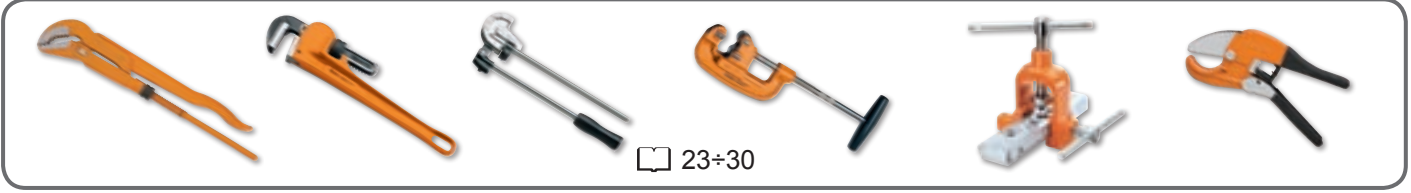

ELETTRONICA E MICROMECCANICA

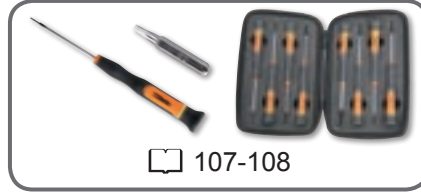

UTENSILI PNEUMATICI E ACCESSORI



☐ 189+202

ACCESSORI PER FUNI ROBUR



☐ 370+389



CALZATURE DI SICUREZZA (E CALZE TECNICHE)



☐ 332+353

ABBIGLIAMENTO DA LAVORO



☐ 354+369

SOLUZIONI PER IL PUNTO VENDITA



☐ 318+331

GAMMA BLISTER



☐ 309+317

BETACOLLECTION



☐ 390+399

Guida alla lettura

numero articolo

profilo utensile 

prezzo unitario

★ articolo fornibile a richiesta

• misura principale

◊ bocca esagonale

misura

numero utensili
nella confezione

numero utensili
nella serie

• tipo confezione

contenuto
della serie

42INOX

chiavi combinate,
in acciaio inossidabile



in confezione blister



novità 2014

mm	L mm	€	
8x8	116	9,50	2 000420308
10x10	137	10,00	2 000420310
11x11	148	10,50	2 000420311
12x12	158	11,00	2 000420312
13x13	169	12,00	2 000420313
14x14	180	12,50	2 000420314
15x15	190	13,00	2 000420315
17x17	212	14,00	2 000420317
19x19	233	16,00	2 000420319



42INOX/SC9	€	
8-10-11-12-13-14-15-17-19 mm	115,00	1 000420387
42/SCV9I	8,00	1 000420103

numero codice

Interpretazione delle sigle più correnti

Esempio

• nelle serie

B	= in busta di plastica	42/B6
BV	= busta vuota	42/BV6
C	= in cassetta	900/C11
D	= in confezione appendibile	1293/D6
S	= in scatola	42/S17
SP	= con supporto	42/SP17
SPV	= supporto vuoto	42/SPV1
SC	= con supporto compatto	96/SC9
SCV	= supporto compatto vuoto	96/SC9

negli assortimenti

AS	= con chiavi in pollici	5915VU/AS
E	= versione Elettronica/Elettrotecnica	5980ET/A
I	= versione Idraulica	5980ID
MT	= versione Movimento Terra	5902MT
U	= versione Universale	5915VU3
SBK	= versione Motoriparazione	5940SBK
VG	= versione Autoriparatori	5904VG/5T
VI	= versione Industria	5902VI

nelle chiavi a bussola

A	= profilo esagonale	910A
B	= profilo poligonale	910B
ES	= profilo esascalato	920ES
FTX	= per viti TORX®	910FTX

Interpretazione delle sigle più correnti

Esempio

PT	= per viti pentalobate	910PT
X	= cricchetto reversibile nelle cassette	920A/C12X

nei giravite e inserti per avvitatori

LP	= per viti con intaglio	920LP
PE	= per viti con impronta esagonale	920PE
PH	= per viti con impronta PHILLIPS®	920PH
PZ	= per viti con impronta POZIDRIV® - SUPADRIV®	1299PZ
RTX	= per viti con impronta TAMPER RESISTANT TORX®	1298RTX
SP	= per viti con impronta SPANNER	861SP
TRW	= per viti con impronta TRI-WING®	861TRW
TQS	= per viti con impronta TORQ-SET®	861TQS
TX	= per viti con impronta TORX®	920TX
XZN	= per viti con impronta XZN®	920XZN

in generale

AS	= misure in pollici	42AS
BA	= utensili antiscintilla	42BA
BM	= impugnatura bimateriale	1150BM
C	= contenitore metallico vuoto	C25
INOX	= utensili acciaio inossidabile	42 INOX
L	= modello lungo	952L
MQ	= utensili isolati a 1000V	1150MQ
MP	= finitura lucida	42MP
R	= ricambio	338R

Le immagini riprodotte sono indicative.

Beta Utensili S.p.A. si riserva il diritto di apportare aggiornamenti e migliorie alla propria gamma produttiva senza preavviso.



Beta RACCOMANDA
il corretto utilizzo degli utensili ed il rispetto
delle disposizioni per la sicurezza individuale.



30

punzoni



Ø mm	L mm	€	🔧	📦
2	125	5,50	10	000300020
3	125	5,50	10	000300030
4	150	6,70	10	000300040
5	150	6,70	10	000300050
6	150	6,70	10	000300060

31

cacciaspina



Ø mm	L mm	L1 mm	€	🔧	📦
2	110	22	5,40	10	000310002
3	128	35	5,40	10	000310003
4	146	45	6,80	10	000310004
5	164	55	7,00	10	000310005
6	182	65	8,70	5	000310006
8	200	80	8,90	5	000310008
10	220	95	10,70	5	000310010



31/B6



31/SP6

31/B6	€ 47,00	🔧 1	📦 000310020
2-3-4-5-6-8 mm			
42/BV6	€ 5,00	🔧 1	📦 000420051
31/SP6	€ 49,00	🔧 1	📦 000310030
2-3-4-5-6-8 mm			
31/SPV	€ 8,00	🔧 1	📦 000310031

31BM

cacciaspina con impugnatura



Ø mm	L mm	L1 mm	€	🔧	📦
2	168	42	11,00	2	000310402
3	180	52	11,50	2	000310403
4	191	62	12,00	2	000310404
5	200	72	13,00	2	000310405
6	221	82	14,50	2	000310406
8	235	94	15,00	2	000310408



31BM/S6	€ 77,00	🔧 1	📦 000310421
2-3-4-5-6-8 mm			

31L

cacciaspina tipo lungo



Ø mm	L mm	L1 mm	€	🔧	📦
4	175	80	7,50	5	000310104
5	175	80	7,50	5	000310105
6	175	80	9,50	5	000310106

31SE

cacciaspina per spine elastiche



Ø mm	D mm	L mm	L1 mm	€	🔧	📦
4	2,4	175	80	7,90	5	000310204
5	3,0	175	80	7,90	5	000310205
6	3,6	175	80	9,80	5	000310206



31/B6-LSE	€ 56,00	🔧 1	📦 000310320
31L: 4-5-6 mm			
31SE: 4-5-6 mm			
31/BV-LSE	€ 6,00	🔧 1	📦 000310022

32

bulini



Ø mm	L mm	L1 mm	€	🔧	📦
3	100	44	4,70	10	000320100
4	125	52	5,60	10	000320125
5	150	62	6,90	10	000320150

32AU

bulino automatico



Ø mm	L mm	L1 mm	€	🔧	📦
3	150	23	39,50	2	000320160

32AUR

punta di ricambio



Ø mm	€	🔧	📦
3	6,50	5	000320170

34

scalpelli piatti



L mm	A mm	L1 mm	€	🔧	📦
125	14,5	45	6,90	5	000340001
150	17,0	58	9,50	5	000340002
175	21,5	68	13,50	5	000340003

35

scalpelli nervati



L mm	A mm	€	🔧	📦
100	14,5	8,20	5	000350001
125	17,0	9,50	5	000350002
150	20,5	11,80	5	000350003
200	23,0	17,80	5	000350004
250	28,5	25,00	2	000350005
300	34,0	35,00	2	000350006

35PM

scalpelli nervati con paramano



L mm	A mm	€	🔧	📦
200	23,0	27,50	2	000350014
250	28,5	34,50	2	000350015
300	34,0	45,50	2	000350016

35PMR

ricambi paramano



L mm	€	🔧	📦
200	9,50	1	000350024
250	9,50	1	000350025
300	10,50	1	000350026

36

ugnetti



L mm	A mm	L1 mm	€	🔧	📦
125	4	44	7,30	5	000360001
150	6	53	8,50	5	000360002

37

ugnetti nervati



L mm	A mm	L1 mm	€	🔧	📦
150	6	45	13,00	5	000370001
200	8	55	19,00	3	000370002

37PM

ugnetto nervato con paramano



L mm	A mm	€	🔧	📦
200	8	29,50	2	000370012

37PMR

ricambio paramano



L mm	€	🔧	📦
200	10,50	1	000370022



38/B6



38/SP6

38/B6	€	🔧	📦
30: 2-3 mm	46,50	1	000380006
32: 4 mm			
34: 125-150 mm			
36: 150 mm			
42/BV6	5,00	1	000420051
38/SP6	48,50	1	000380009
30: 2-3 mm	8,00	1	000380019
32: 4 mm			
34: 125-150 mm			
36: 150 mm			

42

chiavi combinate



DIN 3113 UNI-ISO 7738

mm	L mm	€	🔧	📦
5,5x5,5	95	5,90	5	000420005
6x6	95	5,90	5	000420006
7x7	105	6,00	5	000420007
8x8	116	6,10	5	000420008
9x9	127	6,30	5	000420009
10x10	137	7,00	5	000420010
11x11	148	7,30	5	000420011
12x12	158	7,50	5	000420012
13x13	169	7,70	5	000420013
14x14	180	8,20	5	000420014
15x15	190	9,20	5	000420015
16x16	201	9,80	5	000420016
17x17	212	10,30	5	000420017
18x18	222	11,30	5	000420018
19x19	233	11,50	5	000420019
20x20	243	12,50	3	000420020
21x21	254	13,20	3	000420021
22x22	264	13,70	3	000420022
23x23	275	14,90	3	000420023
24x24	285	16,00	3	000420024
25x25	296	16,80	2	000420025
26x26	307	17,50	2	000420026
27x27	317	18,60	2	000420027
28x28	328	20,00	2	000420028
29x29	338	21,20	2	000420029
30x30	349	22,30	2	000420030
32x32	370	25,00	2	000420032
34x34	391	42,00	1	000420034
35x35	412	46,00	1	000420035
36x36	412	48,00	1	000420036
38x38	433	54,00	1	000420038
41x41	465	64,00	1	000420041



42/B6	€	🔧	📦
6-7-8-10-11-13 mm	45,00	1	000420049
42/BV6	5,00	1	000420051
42/B9	77,00	1	000420064
6-7-8-10-11-13-14-17-19 mm	7,00	1	000420056
42/BV9			



42/S15	€	🔧	📦
6-7-8-10-11-12-13-14 17-19-22-24-27-30-32 mm	173,00	1	000420066
42/S17	153,50	1	000420065
6-7-8-9-10-11-12-13-14-15 16-17-18-19-20-21-22 mm	326,00	1	000420070
42/S26			
6-7-8-9-10-11-12-13-14 15-16-17-18-19-20-21 22-23-24-25-26-27-28 29-30-32 mm			

42/SC9I-E

serie di 9 chiavi combinate con supporto compatto



42/SC9I	€	🔧	📦
8-10-11-12-13-14-15-17-19 mm	81,50	1	000420087
42/SCV9I	8,00	1	000420103
42/SC9E	85,00	1	000420088
8-10-11-12-13-16-17-18-19 mm	8,00	1	000420104
42/SCV9E			



42/SP17	€	🔧	📦
6-7-8-9-10-11-12-13-14-15 16-17-18-19-20-21-22 mm	175,50	1	000420075
42/SPV1	22,00	1	000420080
42/SP25	335,00	1	000420085
6-7-8-9-10-11-12-13-14 15-16-17-18-19-20-21 22-23-24-25-26-27-28 30-32 mm	30,00	1	000420090
42/SPV2			

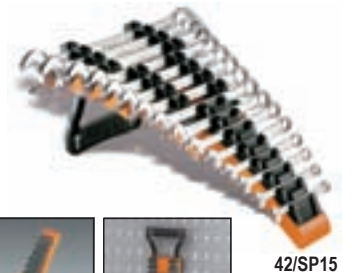

42/SP15



42/SPV...

42/SP15	€	🔧	📦
6-7-8-9-10-11-12-13-14-15 16-17-19-22-24 mm	137,00	1	000420078
42/SPV7	5,00	1	000420097
42: 8-10-11-13-14-17-19 mm 55: 6x7-8x9-10x11-12x13 14x15-16x17-18x19 mm	8,00	1	000420100
42/SPV11			
42MP: 8-9-10-11-12-13 14-15-16-17-19 mm 142-142SN: 8-9-10-11-12-13 14-15-16-17-19 mm	11,00	1	000420102
42/SPV15			
42: 6-7-8-9-10-11-12-13-14 15-16-17-19-22-24 mm			

Beta



42AS

chiavi combinate



mm	L mm	€		
1/4x1/4	95	7,10	2	000420106
5/16x5/16	116	7,30	2	000420108
3/8x3/8	137	7,90	2	000420110
7/16x7/16	148	8,30	2	000420111
1/2x1/2	169	8,90	2	000420113
9/16x9/16	180	9,60	2	000420114
5/8x5/8	201	11,40	2	000420116
11/16x11/16	212	12,00	2	000420117
3/4x3/4	233	13,10	2	000420119
13/16x13/16	254	15,50	2	000420121
7/8x7/8	264	16,10	2	000420122
15/16x15/16	285	18,60	2	000420124
1x1	296	19,30	2	000420125
1.1/16x1.1/16	317	21,30	2	000420127
1.1/8x1.1/8	338	22,20	2	000420129
1.1/4x1.1/4	370	29,50	2	000420132
1.5/16x1.5/16	391	42,00	1	000420133
1.3/8x1.3/8	412	52,00	1	000420135
1.7/16x1.7/16	412	54,00	1	000420136
1.1/2x1.1/2	433	59,00	1	000420138



42AS/B9	92,50	1	000420155
1/4-5/16-3/8-7/16-1/2 9/16-5/8-11/16-3/4			



42AS/13	155,00	1	000420163
1/4-5/16-3/8-7/16-1/2-9/16-5/8 11/16-3/4-13/16-7/8-15/16-1			

42MP

chiavi combinate lucide



DIN 3113 UNI-ISO 7738

mm	L mm	€		
6x6	95	9,00	5	000420606
7x7	105	9,00	5	000420607
8x8	116	9,00	5	000420608
9x9	127	9,50	5	000420609
10x10	137	9,70	5	000420610
11x11	148	9,90	5	000420611
12x12	158	10,10	5	000420612
13x13	169	10,30	5	000420613
14x14	180	10,80	5	000420614
15x15	190	11,70	5	000420615
16x16	201	12,60	5	000420616
17x17	212	13,50	5	000420617
18x18	222	14,50	5	000420618
19x19	233	15,00	5	000420619
20x20	243	16,60	3	000420620

mm	L mm	€		
21x21	254	17,30	3	000420621
22x22	264	17,90	3	000420622
24x24	285	20,50	3	000420624
27x27	317	24,00	3	000420627
30x30	349	29,50	3	000420630
32x32	370	32,00	3	000420632



42MP/B9	103,00	1	000420651
6-7-8-10-11-13-14-17-19 mm			
42/BV9	7,00	1	000420056

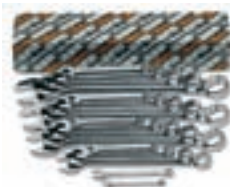

42MP/S17	206,50	1	000420652
6-7-8-9-10-11-12-13-14-15 16-17-18-19-20-21-22 mm			
42MP/S21	312,00	1	000420653
6-7-8-9-10-11-12-13-14 15-16-17-18-19-20-21-22 24-27-30-32 mm			

42LMP

chiavi combinate lunghe lucide



mm	L mm	€		
8x8	148	9,35	2	000420508
9x9	167	9,70	2	000420509
10x10	172	10,10	2	000420510
11x11	186	10,60	2	000420511
12x12	197	10,90	2	000420512
13x13	207	11,00	2	000420513
14x14	223	11,70	2	000420514
15x15	233	12,90	2	000420515
16x16	243	13,90	2	000420516
17x17	261	14,90	2	000420517
18x18	270	16,00	2	000420518
19x19	280	16,50	2	000420519
21x21	301	19,00	2	000420521
22x22	318	19,70	2	000420522
24x24	338	22,60	2	000420524
27x27	376	26,00	2	000420527
30x30	394	32,50	2	000420530
32x32	435	35,00	2	000420532



42LMP/S14	186,00	1	000420551
8-9-10-11-12-13-14 15-16-17-18-19-21-22 mm			
42LMP/S18	302,00	1	000420552
8-9-10-11-12-13-14 15-16-17-18-19-21-22 24-27-30-32 mm			

45

chiavi combinate tipo pesante



DIN 3113 UNI-ISO 7738

mm	L mm	€		
46x46	520	157,00	1	000450046
50x50	560	185,00	1	000450050
55x55	610	260,00	1	000450055
60x60	660	355,00	1	000450060
65x65	710	425,00	1	000450065
70x70	760	470,00	1	000450070
75x75	810	540,00	1	000450075
80x80	860	650,00	1	000450080

52

chiavi a forchetta semplici



UNI 6733 DIN 3114

mm	L mm	€		
10	119	6,70	5	000520010
11	119	6,70	5	000520011
12	119	6,70	5	000520012
13	145	7,50	5	000520013
14	145	7,50	5	000520014
15	145	8,20	5	000520015
16	159	8,20	5	000520016
17	159	9,00	5	000520017
18	159	9,00	5	000520018
19	175	10,50	5	000520019
20	175	10,50	5	000520020
21	175	10,50	5	000520021
22	196	12,80	2	000520022
23	196	12,80	2	000520023
24	196	12,80	2	000520024
25	215	14,30	2	000520025
26	215	14,30	2	000520026
27	215	14,30	2	000520027
28	240	18,80	2	000520028
30	240	18,80	2	000520030
32	270	23,20	2	000520032
34	270	23,20	1	000520034
35	295	28,00	1	000520035
36	295	28,00	1	000520036
38	295	28,00	1	000520038
40	335	39,00	1	000520040
41	335	39,00	1	000520041
42	335	39,00	1	000520042
45	370	49,00	1	000520045
46	370	49,00	1	000520046
48	370	53,00	1	000520048
50	415	64,00	1	000520050
52	415	73,00	1	000520052
55	415	75,00	1	000520055
60	490	97,00	1	000520060
65	490	101,00	1	000520065
70	490	113,00	1	000520070

Beta

EST. 1962

53

chiavi a forchetta DIN 894



mm	L mm	€		
36	317	17,50	1	000530036
38	320	19,50	1	000530038
41	342	23,00	1	000530041
46	396	28,00	1	000530046
50	412	48,00	1	000530050
55	457	55,00	1	000530055
60	492	65,00	1	000530060
65	528	78,00	1	000530065
70	572	94,00	1	000530070
75	608	115,00	1	000530075
80	645	144,00	1	000530080
85	690	178,00	1	000530085
90	690	198,00	1	000530090
95	847	295,00	1	000530095
100	847	311,00	1	000530100
105	1000	400,00	1	000530105
110	1000	430,00	1	000530110
115	1000	480,00	1	000530115
120	1000	540,00	1	000530120
125	1000	645,00	1	000530125
130	1000	670,00	1	000530130
135	1000	745,00	1	000530135

55

chiavi a forchetta doppie



UNI-ISO 10102 DIN 3110

mm	L mm	€		
4x5	101	4,20	5	000550003
5x5,5	101	4,80	5	000550006
5,5x7	120	4,80	5	000550009
6x7	120	3,70	5	000550012
7x8	140	4,70	5	000550018
8x9	140	3,80	5	000550021
8x10	140	4,70	5	000550024
10x11	155	4,00	5	000550030
10x12	155	5,40	5	000550033
10x13	170	5,90	5	000550035
12x13	170	4,50	5	000550042
12x14	170	6,10	5	000550045
13x14	185	7,00	5	000550047
13x17	189	7,40	5	000550051
14x15	185	5,70	5	000550054
14x17	189	7,90	5	000550057
16x17	202	6,50	5	000550060
17x19	220	8,70	2	000550063
18x19	220	7,80	2	000550066
19x22	236	10,00	2	000550069
20x22	236	8,90	2	000550075
21x23	245	9,50	2	000550078
22x24	245	11,00	2	000550081
24x26	262	11,00	2	000550087
24x27	262	12,50	2	000550090
25x28	272	12,50	2	000550096
27x29	284	14,50	2	000550099
27x30	284	16,50	2	000550102
27x32	297	18,10	2	000550105
30x32	297	16,00	2	000550108
32x36	325	45,00	1	000550114
34x36	325	45,00	1	000550117
35x38	375	48,00	1	000550120
36x41	375	51,00	1	000550123
41x46	425	65,00	1	000550129
46x50	475	80,00	1	000550132
50x55	500	89,00	1	000550135
55x60	500	99,00	1	000550138



€		
34,00	1	000550150
6,00	1	000550151
52,00	1	000550158
7,00	1	000550159
104,00	1	000550162
10,00	1	000550163



€		
45,00	1	000550174
94,00	1	000550178
95,50	1	000550179
108,50	1	000550182

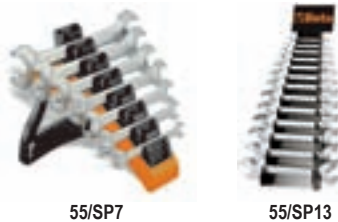

€		
38,00	1	000550167
5,00	1	000420097
128,50	1	000550186
20,00	1	000550190



55AS

chiavi a forchetta doppie



mm	L mm	€		
1/4x9/32	120	5,00	2	000550203
1/4x5/16	120	5,00	2	000550206
5/16x11/32	140	5,40	2	000550209
5/16x3/8	140	5,40	2	000550212
3/8x7/16	155	5,70	2	000550215
7/16x1/2	170	6,30	2	000550218
1/2x9/16	170	6,30	2	000550221
9/16x5/8	185	7,70	2	000550224
19/32x11/16	189	9,20	2	000550227
5/8x11/16	202	9,20	2	000550230
5/8x3/4	202	10,50	2	000550233
11/16x13/16	220	10,50	2	000550242
3/4x7/8	236	12,00	2	000550245
25/32x13/16	236	12,00	2	000550244
7/8x15/16	245	12,50	2	000550251
15/16x1	262	15,50	1	000550257
1x1.1/8	272	16,00	1	000550259
1.1/16x1.1/4	284	22,00	1	000550267
1.1/8x1.5/16	297	22,00	1	000550266
1.5/16x1.1/2	325	53,00	1	000550269
1.3/8x1.1/2	375	58,00	1	000550272
1.7/16x1.5/8	375	58,00	1	000550275

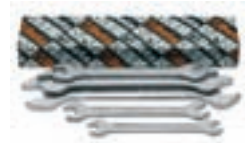

€		
38,50	1	000550290
73,00	1	000550295
126,50	1	000550300

55MP

chiavi a forchetta doppie lucide



UNI-ISO 10102 DIN 3110

mm	L mm	€		
6x7	120	5,00	2	000550603
8x9	140	5,50	2	000550606
10x11	155	5,70	2	000550609
12x13	170	6,50	2	000550612
14x15	185	7,70	2	000550615
16x17	202	9,00	2	000550618
18x19	220	10,80	2	000550621
20x22	236	12,40	2	000550624
21x23	245	13,00	2	000550627
24x26	262	15,20	1	000550630
25x28	272	15,90	1	000550633
27x29	284	19,20	1	000550636
30x32	297	21,50	1	000550639

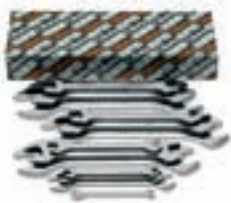

55MP/S8	€	1	000550650
6x7-8x9-10x11-12x13	62,50		
14x15-16x17-18x19			
20x22 mm			
55MP/S13	€	1	000550651
6x7-8x9-10x11-12x13	147,50		
14x15-16x17-18x19			
20x22-21x23-24x26			
25x28-27x29-30x32 mm			

58

chiavi a forchetta a percussione



DIN 133

mm	L mm	€	1	000580024
24	177	21,00		
27	180	23,00		
30	190	26,00		
32	190	27,00		
36	215	35,00		
41	235	44,00		
46	255	59,00		
50	275	65,00		
55	300	78,00		
60	320	86,00		
65	342	112,00		
70	375	143,00		
75	375	153,00		
80	408	204,00		
85	408	230,00		
90	445	270,00		
95	445	280,00		
100	485	425,00		
105	485	480,00		
110	510	523,00		
115	510	609,00		
120	545	618,00		
125	545	716,00		
130	575	920,00		
135	575	970,00		
*140	575	1.050,00		
*145	640	1.450,00		
*150	640	1.500,00		
*155	640	1.580,00		
*160	640	1.760,00		
*165	715	1.890,00		
*170	715	2.560,00		
*175	715	2.720,00		
*180	715	2.970,00		
*185	715	3.040,00		
*190	800	3.300,00		
*195	800	3.510,00		
*200	800	3.680,00		
*210	800	4.530,00		
*220	800	5.910,00		
*230	800	7.190,00		

73

chiavi a forchetta doppie piccole



UNI 6737

mm	L mm	€	5	000730040
4x4	78	6,50		
4,5x4,5	78	6,50		
5x5	78	6,50		
5,5x5,5	86	7,10		
6x6	86	7,10		
7x7	86	7,10		
8x8	97	7,40		
9x9	97	7,40		
10x10	108	7,90		
11x11	108	7,90		
12x12	124	8,70		
13x13	124	8,70		
14x14	124	8,70		



73/B13	€	1	000730200
4-4,5-5-5,5-6-7-8-9	103,50		
10-11-12-13-14 mm			
73/BV	€	1	000730201



73/S13	€	1	000730210
4-4,5-5-5,5-6-7-8-9	97,50		
10-11-12-13-14 mm			

78

chiavi poligonali a percussione



DIN 7444

mm	L mm	€	1	000780024
24	162	23,00		
27	180	27,00		
30	190	33,00		
32	190	34,00		
36	205	42,50		
41	225	55,00		
46	235	60,00		
50	250	72,00		
55	265	80,00		
60	275	95,00		
65	295	120,00		
70	325	125,00		
75	325	145,00		
80	350	220,00		
85	350	245,00		
90	390	300,00		
95	390	340,00		
100	420	380,00		
105	420	450,00		
110	450	505,00		
115	450	560,00		

mm	L mm	€	1	000780120
120	490	870,00		
125	480	1.120,00		
130	520	1.220,00		
135	520	1.300,00		
*140	520	1.480,00		
*145	580	1.920,00		
*150	580	2.050,00		
*155	580	2.190,00		
*160	650	2.270,00		
*165	650	2.420,00		
*170	650	2.950,00		
*175	650	3.200,00		
*180	650	3.490,00		
*185	695	3.600,00		
*190	695	3.860,00		
*195	695	3.910,00		
*200	695	3.990,00		
*210	740	4.220,00		
*215	740	4.800,00		
*220	740	5.320,00		
*230	740	6.630,00		

78AS

chiavi poligonali a percussione



"	L mm	€	1	000780332
*1.1/4	197	35,50		
*1.5/16	197	35,50		
*1.3/8	223	40,00		
*1.7/16	223	46,00		
*1.1/2	223	46,00		
*1.5/8	223	55,00		
*1.11/16	225	58,00		
*1.13/16	240	63,50		
*1.7/8	250	63,50		
*2	250	73,50		
*2.1/16	250	76,00		
*2.3/16	275	81,00		
*2.3/8	270	105,00		
*2.9/16	302	115,00		
*2.3/4	350	125,00		
*2.15/16	350	140,00		
*3.1/8	354	220,00		

80

chiavi a bussola poligonale snodate doppie



mm	L mm	€	3	000800006
6x7	170	26,00		
8x9	176	26,50		
8x10	179	26,50		
10x11	182	28,50		
12x13	228	31,00		
14x15	232	32,50		
13x17	231	34,50		
16x17	234	34,50		
18x19	285	41,00		
19x22	287	43,50		
20x22	289	43,50		
21x23	289	45,00		
24x27	405	70,00		
30x32	413	75,00		



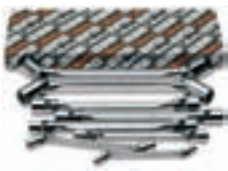

80/S8	€ 263,00	1	000800051
6x7-8x9-10x11-12x13-14x15 16x17-18x19-20x22 mm			
80/S11	€ 453,00	1	000800056
6x7-8x9-10x11-12x13 14x15-16x17-18x19-20x22 21x23-24x27-30x32 mm			

83

chiavi poligonali per starter



ISO 3318

mm	L mm	€		
8x10	126	12,00	3	000830008
10x12	137	12,50	3	000830010
11x13	138	13,00	3	000830011
14x17	183	16,00	3	000830014
15x17	184	18,00	2	000830015
16x18	196	19,50	2	000830016
19x22	231	26,00	2	000830019



83/S3	€ 55,00	1	000830081
11x13-14x17-19x22 mm			
83/S5	€ 89,00	1	000830085
10x12-11x13-15x17 16x18-19x22 mm			

83AS

chiavi poligonali per starter



"	L mm	€		
7/16x1/2	138	14,50	2	000830111
9/16x5/8	183	18,00	2	000830114
3/4x7/8	230	29,00	2	000830119

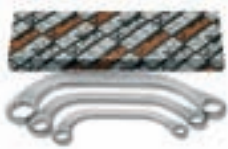

83AS/3	€ 61,50	1	000830181
7/16x1/2-9/16x5/8 3/4x7/8			

90

chiavi poligonali doppie curve



UNI 6740 DIN 838 ISO 10104

mm	L mm	€		
6x7	165	7,30	5	000900006
8x9	180	7,80	5	000900012
8x10	180	9,10	5	000900015
10x11	195	8,20	5	000900018
10x12	195	9,20	5	000900021
11x13	215	10,30	5	000900024
12x13	215	9,20	5	000900027
12x14	215	10,80	5	000900030
14x15	230	9,90	5	000900033
14x17	250	12,80	5	000900036
16x17	250	11,50	5	000900039
17x19	265	14,90	5	000900042
18x19	265	13,50	5	000900045
19x22	285	17,00	3	000900048
20x22	285	15,30	3	000900051
21x23	305	16,70	2	000900057
22x24	305	19,40	2	000900060
24x26	325	19,10	2	000900063
24x27	325	22,20	2	000900067
25x28	340	21,50	2	000900070
27x29	355	24,00	2	000900073
27x30	355	28,00	2	000900076
27x32	375	31,00	2	000900078
30x32	375	27,00	2	000900080
32x36	395	44,00	1	000900088
34x36	415	46,00	1	000900089
35x38	415	48,00	1	000900091
36x41	435	55,00	1	000900094
41x46	460	87,00	1	000900097
46x50	500	117,00	1	000900100



90/B8	€ 91,50	1	000900154
6x7-8x9-10x11-12x13 14x15-16x17-18x19 20x22 mm			
90/BV8	€ 9,00	1	000900155



90/S8	€ 82,50	1	000900162
6x7-8x9-10x11-12x13 14x15-16x17-18x19 20x22 mm			
90/S12	€ 167,00	1	000900166
6x7-8x9-10x11-12x13 14x15-16x17-18x19 20x22-21x23-24x26 25x28-30x32 mm			
90/S12X	€ 170,00	1	000900167
6x7-8x9-10x11-12x13 14x15-16x17-18x19 20x22-21x23-24x27 25x28-30x32 mm			
90/S13	€ 191,00	1	000900170
6x7-8x9-10x11-12x13 14x15-16x17-18x19 20x22-21x23-24x26 25x28-27x29-30x32 mm			



90/SP13	€ 211,00	1	000900174
6x7-8x9-10x11-12x13 14x15-16x17-18x19 20x22-21x23-24x26 25x28-27x29-30x32 mm			
55/SPV	€ 20,00	1	000550190

90AS

chiavi poligonali doppie curve



"	L mm	€		
1/4x5/16	165	8,60	2	000900203
5/16x11/32	180	9,10	2	000900206
5/16x3/8	180	9,40	2	000900209
3/8x7/16	195	9,60	2	000900212
7/16x1/2	215	10,80	2	000900215
1/2x9/16	230	11,90	2	000900218
9/16x5/8	230	11,90	2	000900221
5/8x11/16	250	13,40	2	000900224
5/8x3/4	265	15,90	2	000900227
11/16x3/4	265	15,90	1	000900230
11/16x13/16	265	15,90	1	000900233
3/4x7/8	285	18,30	1	000900237
13/16x7/8	285	18,30	1	000900240
7/8x15/16	305	20,00	1	000900243
15/16x1	325	22,40	1	000900252
1.1/16x1.1/4	375	32,00	1	000900258
1.1/8x1.5/16	375	32,00	1	000900261

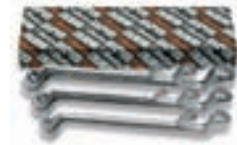

90AS/8	€ 109,00	1	000900298
1/4x5/16-5/16x11/32 3/8x7/16-1/2x9/16 5/8x11/16-11/16x3/4 13/16x7/8-15/16x1			
90AS/10	€ 173,00	1	000900300
1/4x5/16-5/16x11/32 3/8x7/16-1/2x9/16 5/8x11/16-11/16x3/4 13/16x7/8-15/16x1 1.1/16x1.1/4-1.1/8x1.5/16			



91

chiavi poligonali curve



Ø mm	Ø mm	€		
24	38	41,00	1	000910024
27	41	42,00	1	000910027
30	48	45,00	1	000910030
32	49	47,50	1	000910032
36	54	53,00	1	000910036
41	62	66,50	1	000910041
46	69	77,00	1	000910046
50	76	88,00	1	000910050
55	81	97,00	1	000910055
60	90	121,00	1	000910060
65	98	135,00	1	000910065
70	105	153,00	1	000910070
75	110	172,00	1	000910075
80	125	199,00	1	000910080
85	125	207,00	1	000910085
90	140	376,00	1	000910090
95	140	410,00	1	000910095
100	143	434,00	1	000910100
105	146	476,00	1	000910105

92

leve di manovra per art. 91



L mm	91 mm	Ø mm	€			
92/1	460	24÷30	19	24,00	1	000920010
92/2	610	32÷41	22	37,00	1	000920020
92/3	760	46÷55	25	55,00	1	000920030
92/4	860	60÷105	30	69,00	1	000920040

93

chiave per ponteggi



Ø mm	L mm	€		
21x22	310	28,00	3	000930021

93C

chiavi a cricchetto per ponteggi



Ø mm	L mm	€		
17x19	315	36,00	1	000930117
19x22	315	39,00	1	000930119
19x24	360	43,00	1	000930120
21x22	315	43,00	1	000930121

94

chiavi per raccordi tubi



DIN 3118

Ø mm	L mm	€		
8x10	140	13,20	2	000940008
9x11	153	13,70	2	000940009
10x11	153	14,30	2	000940010
11x13	175	14,80	2	000940011
12x14	175	15,40	2	000940012
14x15	175	18,60	2	000940014
14x17	195	19,10	2	000940015
17x19	212	19,30	2	000940017
19x22	228	20,00	2	000940019
22x24	242	26,00	2	000940022
24x27	260	28,00	2	000940024
30x32	300	36,00	2	000940030
36x41	320	57,50	1	000940036



94/S6	€		
8x10-10x11-11x13-12x14-17x19-19x22 mm	97,00	1	000940050
94/S10	200,50	1	000940052
8x10-9x11-10x11-11x13-12x14-17x19-19x22-22x24-24x27-30x32 mm			

Beta

95

chiavi poligonali doppie diritte



DIN 837 ISO 10103

Ø mm	L mm	€		
6x7	120	7,50	3	000950161
8x9	135	8,50	3	000950162
10x11	150	9,40	3	000950163
12x13	165	10,30	3	000950164
14x15	185	10,70	3	000950165
16x17	210	12,00	3	000950166
17x19	225	14,20	3	000950167
18x19	225	13,50	2	000950168
20x22	240	14,90	2	000950169
21x23	255	15,90	2	000950170
24x26	270	17,80	2	000950171
25x28	285	20,50	2	000950172
27x29	315	21,50	2	000950173
30x32	335	24,00	2	000950174



95/S8	€		
6x7-8x9-10x11-12x13-14x15-16x17-18x19-20x22 mm	87,00	1	000950177
95/S13	186,50	1	000950179
6x7-8x9-10x11-12x13-14x15-16x17-18x19-20x22-21x23-24x26-25x28-27x29-30x32 mm			

95FTX

chiavi doppie diritte per viti con teste a profilo Torx®



Ø mm	L mm	€		
E6xE8	115	11,30	2	000950306
E10xE12	143	12,10	2	000950310
E14xE18	177	12,70	2	000950314
E20xE24	224	15,20	2	000950320



95FTX/S4	€		
E6xE8-E10xE12-E14xE18-E20xE24	51,50	1	000950325

96

chiavi maschio esagonale piegate cromate

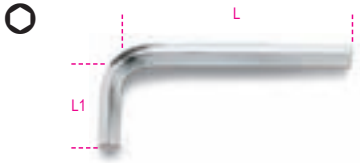

mm	L mm	L1 mm	€	🔧	📦
1,5	45	15	0,70	20	000960015
2	50	17	0,75	20	000960020
2,5	57	20	0,75	20	000960025
3	64	22	0,85	20	000960030
3,5	68	25	1,05	20	000960035
4	72	28	1,10	20	000960040
4,5	78	30	1,15	20	000960045
5	83	32	1,25	20	000960050
6	94	37	1,50	20	000960060
7	99	40	1,90	10	000960070
8	105	43	2,25	10	000960080
9	111	46	2,50	10	000960090
10	119	49	3,10	10	000960100
11	126	52	3,70	10	000960110
12	134	56	4,50	10	000960120
13	142	62	5,80	10	000960130
14	151	69	6,70	10	000960140
16	165	75	9,80	5	000960160
17	174	79	10,50	5	000960170
19	196	88	14,50	5	000960190
22	216	100	23,00	3	000960220
24	242	112	29,50	1	000960240
27	271	125	41,00	1	000960270
30	309	140	54,00	1	000960300
32	341	155	75,00	1	000960312
36	385	174	107,00	1	000960316



96/ST6
2,5-3-4-5-6-8 mm € 11,00 3 000960370



96/BGS7
1,5-2-2,5-3-4-5-6 mm € 22,00 1 000960367



96/BG7
2,5-3-4-5-6-8-10 mm € 23,50 1 000960368



96/B8
2-2,5-3-4-5-6-8-10 mm € 13,10 5 000960386

96/B10
1,5-2-2,5-3-4-5-6-8-10-12 mm € 18,30 5 000960380

96N/BV € 1,50 1 000960651



96/SC9
1,5-2-2,5-3-4-5-6-8-10 mm € 15,30 1 000960374

96/SCV € 3,00 1 000960985



96/SC12
2-2,5-3-3,5-4-4,5-5-6-7-8-9-10 mm € 21,70 1 000960395

96/SCV12 € 3,50 1 000960975

96N
chiavi maschio esagonale piegate brunite



mm	L mm	L1 mm	€	🔧	📦
0,9	32	10	0,36	20	000960409
1,3	44	12	0,36	20	000960413
1,5	46	15	0,36	20	000960415
2	51	17	0,40	20	000960420
2,5	57	20	0,42	20	000960425
3	64	22	0,46	20	000960430
3,5	68	25	0,55	20	000960435
4	72	28	0,62	20	000960440
4,5	78	30	0,67	20	000960445
5	83	32	0,70	20	000960450
6	94	37	0,90	20	000960460
7	99	40	1,20	10	000960470
8	105	43	1,40	10	000960480
9	111	46	1,85	10	000960490
10	119	49	2,20	10	000960500
11	126	52	2,60	10	000960510
12	134	56	3,10	10	000960520
13	142	62	4,50	10	000960530
14	151	69	5,00	10	000960540
16	165	72	7,50	5	000960560
17	174	79	8,00	5	000960570
19	194	88	11,00	5	000960590



96N/ST6
2,5-3-4-5-6-8 mm € 7,80 3 000960640



96N/G7
2,5-3-4-5-6-8-10 mm € 18,50 3 000960645

96N/G7A
1,5-2-2,5-3-4-5-6 mm € 13,00 3 000960643



96N/B10
1,5-2-2,5-3-4-5-6-8-10-12 mm € 12,10 5 000960650

96N/BV € 1,50 1 000960651



96N/SC9
1,5-2-2,5-3-4-5-6-8-10 mm € 10,50 1 000960644

96N/SCV € 3,00 1 000960986



96N/SC12
2-2,5-3-3,5-4-4,5-5-6-7-8-9-10 mm € 14,90 1 000960661

96N/SCV12 € 3,50 1 000960976



96AS

chiavi maschio esagonale piegate
brunite



"	L mm	L1 mm	€	🔧	📦
1/30	44	14	0,70	20	000960698
1/20	44	15	0,70	20	000960701
1/16	46	16	0,75	20	000960702
5/64	50	18	0,90	20	000960704
3/32	53	19	1,05	20	000960706
7/64	57	21	1,10	20	000960708
1/8	60	22	1,10	20	000960710
9/64	64	24	1,35	20	000960712
5/32	68	25	1,35	20	000960714
3/16	75	29	1,50	20	000960716
7/32	82	32	1,70	20	000960718
1/4	89	35	1,95	20	000960720
5/16	103	40	2,35	10	000960724
3/8	117	44	2,95	10	000960728
7/16	132	49	4,20	10	000960730
1/2	149	54	5,35	10	000960732



96AS/T7	€ 15,20	🔧 3	📦 000960740
3/32-1/8-5/32			
3/16-7/32-1/4-5/16			



96AS/G7	€ 19,90	🔧 3	📦 000960745
3/32-1/8-5/32			
3/16-1/4-5/16-3/8			



96AS/BG7	€ 23,00	🔧 1	📦 000960747
3/32-1/8-5/32-3/16			
1/4-5/16-3/8			



96AS/B11	€ 17,80	🔧 1	📦 000960749
1/20-1/16-5/64-3/32			
1/8-5/32-3/16-7/32			
1/4-5/16-3/8			
96N/BV	€ 1,50	🔧 1	📦 000960651

96LC

chiavi maschio esagonale piegate
tipo lungo, cromate



mm	L mm	L1 mm	€	🔧	📦
2	101	17	1,35	20	000960320
2,5	113	20	1,40	20	000960321
3	127	22	1,55	20	000960322
3,5	138	25	1,60	20	000960323
4	142	28	1,75	20	000960324
4,5	154	28	2,10	20	000960325
5	163	32	2,25	20	000960326
6	184	37	2,45	20	000960327
7	194	40	2,75	10	000960328
8	205	43	3,35	10	000960329
9	216	46	3,70	10	000960330
10	231	49	4,90	10	000960331
12	259	56	6,00	10	000960332



96LC/SC8	€ 22,00	🔧 1	📦 000960334
2-2,5-3-4-5-6-8-10 mm			
96LC/SCV	€ 3,00	🔧 1	📦 000960983



96LC/SC12	€ 32,50	🔧 1	📦 000960337
2-2,5-3-3,5-4-4,5-5			
6-7-8-9-10 mm			
96LC/SCV12	€ 3,50	🔧 1	📦 000960977

96L

chiavi maschio esagonale piegate
tipo lungo, brunite



mm	L mm	L1 mm	€	🔧	📦
2	99	15	1,01	20	000960820
2,5	110	17	1,05	20	000960825
3	124	19	1,15	20	000960830
3,5	135	21	1,25	20	000960835
4	138	24	1,35	20	000960840
4,5	150	25	1,60	20	000960845
5	158	27	1,70	20	000960850
6	178	31	1,90	20	000960860
7	187	33	2,30	10	000960870
8	197	35	2,95	10	000960880
9	207	37	3,25	10	000960890
10	221	39	4,40	10	000960900
12	247	44	5,50	10	000960920



96L/SC8	€ 18,50	🔧 1	📦 000960924
2-2,5-3-4-5-6-8-10 mm			
96L/SCV	€ 3,00	🔧 1	📦 000960987



96L/SC12	€ 27,50	🔧 1	📦 000960929
2-2,5-3-3,5-4-4,5-5			
6-7-8-9-10 mm			
96L/SCV12	€ 3,50	🔧 1	📦 000960978

96BPC

chiavi maschio esagonale piegate
con estremità sferica, cromate

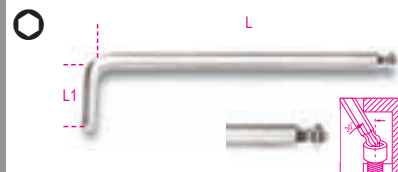

mm	L mm	L1 mm	€	🔧	📦
1,5	79	13	1,65	10	000960340
2	84	15	1,75	10	000960341
2,5	89	17	1,85	10	000960342
3	99	19	1,90	10	000960343
4	108	24	2,30	10	000960344
5	126	27	2,70	10	000960345
6	148	31	4,00	10	000960346
7	157	33	5,20	5	000960353
8	168	35	5,40	5	000960347
10	187	39	8,80	5	000960348



96BPC/SC9	€ 33,50	🔧 1	📦 000960354
1,5-2-2,5-3-4-5-6-8-10 mm			
96BPC/SCV	€ 3,00	🔧 1	📦 000960984



96BP

chiavi maschio esagonale
piegate con estremità sferica, brunate

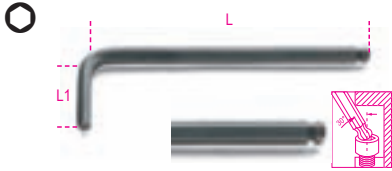

mm	L mm	L1 mm	€	🔧	📦
1,5	79	13	1,25	10	000960960
2	84	15	1,35	10	000960961
2,5	89	17	1,40	10	000960962
3	99	19	1,45	10	000960963
4	108	24	1,70	10	000960965
5	126	27	2,30	10	000960967
6	148	31	3,30	10	000960968
8	168	35	4,70	5	000960970
10	187	39	8,20	5	000960972



96BP/SC9	€ 28,50	🔧 1	📦 000960974
1,5-2-2,5-3-4-5-6-8-10 mm			
96BP/SCV	€ 3,00	🔧 1	📦 000960988

96LBP

chiavi maschio esagonale
piegate con estremità sferica,
modello extralungo, cromate

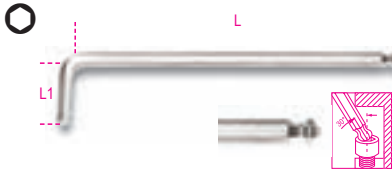

mm	L mm	L1 mm	€	🔧	📦
1,5	90	15	1,85	5	000961340
2	100	17	1,95	5	000961341
2,5	112	20	2,05	5	000961342
3	127	22	2,10	5	000961343
4	144	27	2,60	5	000961344
5	163	32	3,30	5	000961345
6	184	37	4,60	5	000961346
8	204	44	6,20	2	000961348
10	230	49	10,40	2	000961350



96LBP/SC9	€ 38,00	🔧 1	📦 000961354
1,5-2-2,5-3-4-5-6-8-10 mm			
96 LBP/SCV	€ 3,00	🔧 1	📦 000961984

96BP/AS

chiavi maschio esagonale
piegate con estremità sferica, brunate

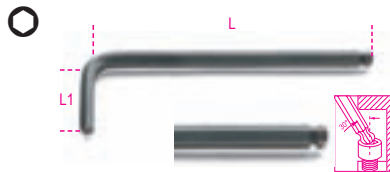

"	L mm	L1 mm	€	🔧	📦
3/32	89	17	1,60	10	000960989
1/8	98	18	1,70	10	000960990
5/32	108	24	2,05	10	000960991
3/16	126	26	2,35	10	000960992
7/32	139	28	3,40	10	000960993
1/4	152	31	3,70	10	000960994
5/16	168	34	4,80	5	000960995
3/8	190	39	8,20	5	000960996



96BP/AS8	€ 29,50	🔧 1	📦 000960997
3/32-1/8-5/32-3/16-7/32			
1/4-5/16-3/8			
96BP/ASBV	€ 1,50	🔧 1	📦 000960998

96BPA

chiavi maschio esagonale
piegate a 110° con estremità sferica,
modello lato extra corto, cromate



mm	L mm	L1 mm	€	🔧	📦
1,5	71	9	1,70	5	000961960
2	86	11	1,80	5	000961961
2,5	96	13	1,90	5	000961962
3	104	15	2,00	5	000961963
4	116	17	2,55	5	000961964
5	132	19	3,05	5	000961965
6	155	21	4,50	5	000961966
8	176	24	6,00	2	000961968
10	200	27	9,50	2	000961970



96BPA/SC9	€ 36,00	🔧 1	📦 000961974
1,5-2-2,5-3-4-5-6-8-10 mm			
96BPA/SCV	€ 3,00	🔧 1	📦 000961988

96T

chiavi maschio esagonale piegate
con impugnatura di manovra

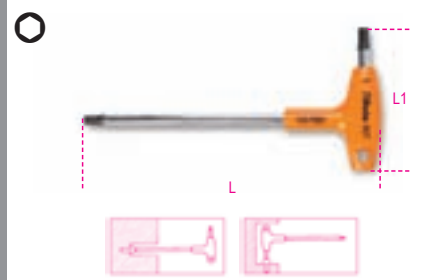

mm	L mm	L1 mm	€	🔧	📦
2	139	52	8,70	5	000960934
2,5	153	55	8,70	5	000960935
3	153	55	8,70	5	000960936
3,5	179	70	9,00	5	000960937
4	179	70	9,00	5	000960938
4,5	200	84	9,30	5	000960939
5	200	84	9,30	5	000960940
6	221	103	10,00	5	000960941
7	236	106	11,00	3	000960942
8	255	117	12,00	3	000960943
10	285	132	14,00	3	000960945



96T/S6	€ 54,50	🔧 1	📦 000960952
2-2,5-3-4-5-6 mm			
96T/S11	€ 109,50	🔧 1	📦 000960951
2-2,5-3-3,5-4-4,5-5-6-7-8-10 mm			



96T/SP11	€ 120,00	🔧 1	📦 000960957
2-2,5-3-3,5-4-4,5-5-6-7-8-10 mm			
96T/SPV	€ 11,50	🔧 1	📦 000960958

96T/AS

chiavi maschio esagonale piegate
con impugnatura di manovra



"	L mm	L1 mm	€	🔧	📦
3/32	153	55	10,80	2	000960669
7/64	153	55	10,80	2	000960670
1/8	179	70	10,80	2	000960671
9/64	179	70	10,90	2	000960672
5/32	200	84	10,90	2	000960673
3/16	200	84	11,00	2	000960674
7/32	221	103	11,80	2	000960675
1/4	236	106	13,50	2	000960676
5/16	255	117	14,70	2	000960678
3/8	285	132	16,70	2	000960680

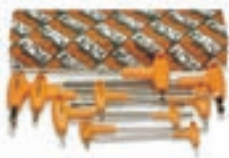

96TAS/10 € 122,00 1 000960683
 3/32-7/64-1/8-9/64-5/32
 3/16-7/32-1/4-5/16-3/8

96TBP

chiavi maschio esagonale piegate
 con estremità sferica ed impugnatura
 di manovra



mm	L mm	L1 mm	€		
2,5	153	55	9,10	3	000960685
3	153	55	9,10	3	000960686
4	179	70	9,30	3	000960687
5	200	84	9,80	3	000960688
6	221	103	10,60	3	000960689
8	255	117	13,50	2	000960690



96TBP/S6 € 61,50 1 000960694
 2,5-3-4-5-6-8 mm

97TX

chiavi maschio piegate
 per viti con impronta Torx®



mm	L mm	L1 mm	€		
T6	42	16	5,15	5	000970006
T7	48	16	5,15	5	000970007
T8	48	16	5,15	5	000970008
T9	48	16	5,60	5	000970009
T10	51	17	5,75	5	000970010
T15	54	18	5,75	5	000970015
T20	57	19	6,10	5	000970020
T25	60	20	6,25	5	000970025
T27	64	21	6,85	5	000970027
T30	70	24	6,85	5	000970030
T40	76	26	7,65	5	000970040
T45	83	29	9,10	5	000970045
T50	95	32	10,30	5	000970050
T55	108	35	13,30	5	000970055
T60	120	38	17,70	5	000970060



97TX/ST8 € 55,50 1 000970640
 T9-T10-T15-T20-T25
 T27-T30-T40



97TX/G8 € 43,00 1 000970645
 T9-T10-T15-T20-T25
 T27-T30-T40



97TX/BG8 € 32,00 1 000970368
 T9-T10-T15-T20-T25-T27-T30-T40



97TX/SC8 € 54,00 1 000970064
 T9-T10-T15-T20-T25
 T27-T30-T40
97TX/SCV € 3,00 1 000970985



97TX/B13 € 87,00 1 000970650
 T6-T7-T8-T9-T10-T15-T20
 T25-T27-T30-T40-T45-T50
96N/BV € 1,50 1 000960651

97BTX

chiavi maschio piegate
 con un'estremità sferica
 per viti con impronta Torx®

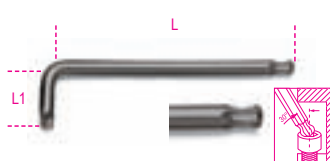

mm	L mm	L1 mm	€		
T9	80	16	6,35	5	000970109
T10	86	17	6,35	5	000970110
T15	90	18	6,35	5	000970115

	L mm	L1 mm	€		
T20	95	19	6,80	5	000970120
T25	100	20	7,15	5	000970125
T27	105	21	7,65	5	000970127
T30	114	24	7,75	5	000970130
T40	124	26	8,75	5	000970140
T45	133	28	10,40	5	000970145
T50	152	32	11,60	3	000970150
T55	164	35	15,30	3	000970155



97BTX/SC8 € 60,00 1 000970164
 T9-T10-T15-T20-T25-T27-T30-T40
97BTX/SCV € 3,00 1 000970983



97BTX/B8 € 58,50 1 000970159
 T9-T10-T15-T20-T25
 T27-T30-T40
96N/BV € 1,50 1 000960651

97RTX

chiavi maschio piegate
 per viti con impronta
 Tamper Resistant Torx®



	L mm	L1 mm	€		
T9	56	16	6,00	5	000970209
T10	62	17	6,15	5	000970210
T15	72	17	6,15	5	000970215
T20	83	18	6,35	5	000970220
T25	90	18	6,55	5	000970225
T27	100	20	7,35	5	000970227
T30	105	24	7,35	5	000970230
T40	112	26	8,20	5	000970240



97RTX/SC8 € 57,00 1 000970263
 T9-T10-T15-T20-T25
 T27-T30-T40
97RTX/SCV € 3,00 1 000970984





97RTX/B8 € 55,50 1 000970260
T9-T10-T15-T20-T25
T27-T30-T40

96N/BV 1,50 1 000960651

97TTX

chiavi maschio piegate
con impugnatura
per viti con impronta Torx®

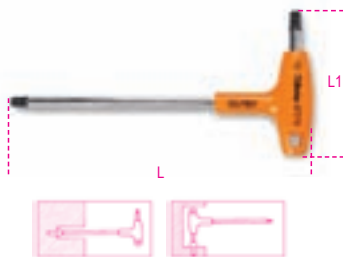

Ø	L	L1	€	Imp.	Info
mm	mm	mm			
T6	130	52	8,20	3	000970706
T7	130	52	8,20	3	000970707
T8	139	52	8,50	3	000970708
T9	139	52	8,50	3	000970709
T10	179	70	8,90	3	000970710
T15	179	70	9,70	3	000970715
T20	179	70	10,10	3	000970720
T25	179	70	10,50	3	000970725
T27	200	84	11,50	3	000970727
T30	200	84	12,30	3	000970730
T40	221	103	14,00	3	000970740
T45	236	106	16,50	2	000970745
T50	255	117	21,50	2	000970750



97TTX/D6 € 65,50 1 000970791
T10-T15-T20-T25-T30-T40

97TTX/S13 148,50 1 000970813
T6-T7-T8-T9-T10-T15-T20-T25
T27-T30-T40-T45-T50



97TTX/SP11 € 142,50 1 000970840
T8-T9-T10-T15-T20-T25
T27-T30-T40-T45-T50

96T/SPV 11,50 1 000960958

98XZN

chiavi a profilo XZN®



Ø	L	L1	€	Imp.	Info
mm	mm	mm			
M5	72	25	4,50	5	000980005
M6	80	28	5,20	5	000980006
M8	90	32	6,55	5	000980008
M10	100	36	8,60	5	000980010
M12	112	40	10,80	5	000980012
M14	125	45	13,70	5	000980014
M16	140	55	20,50	5	000980016



98XZN/B5 € 37,00 1 000980650
M5-M6-M8-M10-M12

96N/BV 1,50 1 000960651

99

chiavi a settore con nasello quadro
per ghiera



UNI 6752

Ø	A	€	Imp.	Info
mm	mm			
12-14	1,5	7,40	3	000990012
16-18-20	1,8	7,40	3	000990016
22-25-28	1,8	9,50	3	000990022
30-32	2,1	9,50	3	000990030
34-36-38	2,4	11,80	3	000990034
40-42	2,4	11,80	3	000990040
45-50	2,5	14,50	3	000990045
52-55-58	2,5	14,50	3	000990052
62-65	3,1	19,00	3	000990062
68-70-75	3,1	19,00	3	000990068
80-85-90	3,8	25,00	2	000990080
92-95	4,3	25,00	2	000990092
98-100	4,3	25,00	2	000990098
105-110-115	4,4	40,00	1	000990105
120-125-130	4,9	40,00	1	000990120
135-145	6,0	60,00	1	000990135
155-165	6,0	60,00	1	000990155

99SQ

chiavi a settore articolate
con nasello quadro



Ø	B	€	Imp.	Info
mm	mm			
15-35	2,7	21,50	2	000990215
35-50	3,5	24,50	2	000990235
50-80	4,7	31,50	2	000990250
80-120	6,2	43,50	2	000990280
120-180	7,8	57,50	2	000990290

99ST

chiavi a settore articolate
con nasello tondo



Ø	B	€	Imp.	Info
mm	mm			
15-35	3,0	22,00	2	000990315
35-50	4,0	26,00	2	000990335
50-80	5,0	34,00	2	000990350
80-120	6,0	46,00	2	000990380
120-180	8,0	59,00	2	000990390

99 VN/...

nasello di ricambio per 99ST

Ø	€	Imp.	Info
mm			
99VN/15	5,00	1	000990295
99VN/35	6,00	1	000990296
99VN/50	7,00	1	000990297
99VN/80	9,00	1	000990298
99VN/120	11,50	1	000990299

100

chiave a compasso con naselli tondi



Ø	L	Ø min-max	€	Imp.	Info
mm	mm	mm			
4,9-5,9	250	18÷100	112,00	1	001000001
6,9-7,9					

100/KIT

naselli di ricambio per art. 100



100/KIT	€	Imp.	Info
	37,00	1	001000010

111

chiavi regolabili a rullino cromate con scala
graduata

- Rotazione destrorsa del rullino
- Scala millimetrata e in pollici



DIN 3117 ISO 6787

L	A max	€	Imp.	Info
mm	mm			
100	15	18,00	3	001110010
150	24	19,00	3	001110015
200	28	23,00	3	001110020
250	34	28,00	3	001110025
300	35	37,00	3	001110030
380	45	68,00	3	001110038
450	54	115,00	2	001110045
600	62	160,00	1	001110060



111N

chiavi regolabili a rullino fosfatate con scala graduata

- Rotazione sinistrorsa del rullino
- Con scala millimetrata e in pollici



DIN 3117 ISO 6787

L mm	A max mm	€	🔧	📦
100	15	16,50	3	001110210
150	24	17,50	3	001110215
200	28	20,50	3	001110220
250	34	25,50	3	001110225
300	35	34,00	3	001110230
380	45	65,00	3	001110238
450	54	110,00	2	001110245

111G

chiavi regolabili a rullino con scala graduata cromate con impugnatura

- Rotazione destrorsa del rullino
- Con scala millimetrata e in pollici
- Impugnatura ergonomica



L mm	A max mm	€	🔧	📦
200	28	26,00	3	001110620
250	34	32,00	3	001110625
300	35	42,00	2	001110630

120

chiavi poligonali aperte a cricchetto



🔧 mm	L mm	€	🔧	📦
10	135	36,50	1	001200010
11	135	36,50	1	001200011
12	135	36,50	1	001200012
13	135	36,50	1	001200013
14	135	43,00	1	001200014
17	185	44,50	1	001200017
19	185	47,50	1	001200019
22	230	66,50	1	001200022
24	230	71,00	1	001200024
27	230	92,00	1	001200027
30	320	102,50	1	001200030
32	320	105,50	1	001200032



120/B6	€ 275,00	🔧 1	📦 001200050
10-11-13 17-19-22 mm			
120/BV	€ 7,00	🔧 1	📦 001200051

123E1/4

adattatore portainserti 1/4"
per chiavi a cricchetto 10 mm

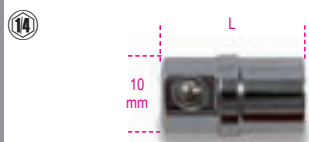

🔧 mm	L mm	€	🔧	📦
10	20,6	4,60	1	001230010

123Q1/4

adattatore a sgancio rapido 1/4"
per chiavi a cricchetto 10 mm

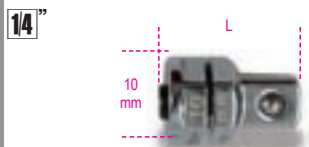

🔧 mm	L mm	€	🔧	📦
10	17,5	5,70	1	001230310

123Q3/8

adattatore a sgancio rapido 3/8"
per chiavi a cricchetto 13 mm



🔧 mm	L mm	€	🔧	📦
13	22,5	5,70	1	001230313

123Q1/2

adattatore a sgancio rapido 1/2"
per chiavi a cricchetto 19 mm

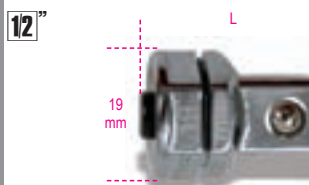

🔧 mm	L mm	€	🔧	📦
19	30,5	6,30	1	001230319

123/K4

kit di 4 adattatori per chiavi a cricchetto:
1 adattatore per bits
3 adattatori a sgancio rapido



123/K4	€ 22,30	🔧 1	📦 001230504
--------	---------	-----	-------------

142

chiavi combinate a cricchetto reversibile

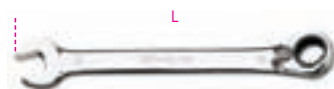

🔧 mm	L mm	€	🔧	📦
6x6	136	12,90	3	001420006
7x7	136	12,90	3	001420007
8x8	136	13,40	3	001420008
9x9	143	14,20	3	001420009
10x10	159	14,70	3	001420010
11x11	168	15,00	3	001420011
12x12	174	15,50	3	001420012
13x13	180	17,00	3	001420013
14x14	190	17,50	2	001420014
15x15	200	18,50	2	001420015
16x16	216	19,80	2	001420016
17x17	233	20,40	2	001420017
18x18	239	22,00	2	001420018
19x19	248	22,60	2	001420019
22x22	285	29,50	1	001420022
24x24	325	34,50	1	001420024
27x27	355	49,00	1	001420027
30x30	420	57,00	1	001420030
32x32	420	59,00	1	001420032



142/B6	€ 112,50	🔧 1	📦 001420066
8-10-13-14-17-19 mm			
142/BV6	€ 7,00	🔧 1	📦 001420076
142/B9	€ 162,50	🔧 1	📦 001420069
8-10-11-12-13-14-15-17-19 mm			
142/BV9	€ 8,00	🔧 1	📦 001420079



142/S15	€ 266,00	🔧 1	📦 001420074
6-7-8-9-10-11-12-13 14-15-16-17-18-19-22 mm			
142/S19	€ 465,00	🔧 1	📦 001420075
6-7-8-9-10-11-12 13-14-15-16-17-18 19-22-24-27-30-32 mm			

142/SC9I-E

serie di 9 chiavi combinate a cricchetto
reversibile con supporto compatto



142/SC9I	€ 161,00	🔧 1	📦 001420087
8-10-11-12-13-14-15-17-19 mm			
142/SCV9I	€ 8,00	🔧 1	📦 001420103
142/SC9E	€ 167,00	🔧 1	📦 001420088
8-10-11-12-13-16-17-18-19 mm			
142/SCV9E	€ 8,00	🔧 1	📦 001420104

142AS

chiavi combinate a cricchetto reversibile



mm	L mm	€	Icona	Icona
5/16x5/16	136	15,40	2	001420308
3/8x3/8	159	16,00	2	001420310
7/16x7/16	168	16,70	2	001420311
1/2x1/2	180	18,80	2	001420313
9/16x9/16	190	18,90	2	001420314
5/8x5/8	216	21,40	2	001420316
11/16x11/16	233	21,90	2	001420317
3/4x3/4	248	24,40	2	001420319



142AS/8	€	Icona	Icona
5/16-3/8-7/16-1/2 9/16-5/8-11/16-3/4	153,50	1	001420330

142C

chiavi combinate corte diritte a cricchetto



mm	L mm	€	Icona	Icona
8x8	88	9,30	2	001420108
9x9	96	9,30	2	001420109
10x10	96	9,60	2	001420110
11x11	100	10,30	2	001420111
12x12	104	10,90	2	001420112
13x13	108	11,50	2	001420113
14x14	114	12,00	2	001420114
15x15	118	12,70	2	001420115
16x16	122	13,20	2	001420116
17x17	128	14,10	2	001420117
18x18	132	15,10	2	001420118
19x19	138	15,70	2	001420119



142C/A12	€	Icona	Icona
8-9-10-11-12-13-14 15-16-17-18-19 mm	165,00	1	001420175

142SN

chiavi combinate a cricchetto snodate



mm	L mm	€	Icona	Icona
7x7	136	15,50	2	001420207
8x8	136	16,20	2	001420208
9x9	143	16,80	2	001420209
10x10	160	17,80	2	001420210
11x11	168	18,30	2	001420211
12x12	174	18,90	2	001420212
13x13	180	20,20	2	001420213
14x14	193	20,80	2	001420214
15x15	200	22,10	2	001420215
16x16	216	23,50	2	001420216
17x17	233	24,00	2	001420217
18x18	239	26,00	2	001420218
19x19	250	26,50	2	001420219
22x22	285	29,00	1	001420222
24x24	325	32,00	1	001420224



142SN/S13	€	Icona	Icona
7-8-9-10-11-12-13-14 15-16-17-18-19 mm	267,00	1	001420263

188

chiavi poligonali diritte e a cricchetto per pulegge libere alternatori



mm	L mm	€	Icona	Icona
10	240	16,00	2	001880010
15	322	22,00	2	001880015

192

chiavi poligonali doppie diritte a cricchetto reversibile 4 in 1



mm	L mm	€	Icona	Icona
8x10/12x13	160	21,50	1	001920008
16x17/18x19	230	27,00	1	001920016



192/S2	€	Icona	Icona
8x10/12x13 16x17/18x19 mm	48,50	1	001920070

194

chiave portainseri a cricchetto reversibile



mm	L mm	€	Icona	Icona
1/4x5/16	128	28,50	2	001940006

195

chiavi poligonali doppie diritte a cricchetto



mm	L mm	€	Icona	Icona
8x10	128	14,50	2	001950010
12x13	170	17,00	2	001950013
14x15	190	17,50	2	001950015
16x18	230	20,50	2	001950018
17x19	230	21,00	2	001950019



195/B5	€	Icona	Icona
8x10-12x13-14x15 16x18-17x19 mm	98,50	1	001950066
195/BV5	8,00	1	001950070

195AS

chiavi poligonali doppie diritte a cricchetto



mm	L mm	€	Icona	Icona
5/16x3/8	128	14,50	2	001950606
7/16x1/2	170	17,00	2	001950611
9/16x5/8	190	19,00	2	001950614
11/16x3/4	230	21,00	2	001950617



195AS/B4	€	Icona	Icona
5/16x3/8 - 7/16x1/2 - 9/16x5/8 - 11/16x3/4	79,50	1	001950654

195P

chiavi poligonali doppie piegate a 15° a cricchetto reversibile



mm	L mm	€	Icona	Icona
8x10	128	22,00	2	001950210
12x13	170	24,00	2	001950213
14x15	190	25,00	2	001950215
16x18	230	28,00	2	001950218
17x19	230	30,00	2	001950219





195P/B5	€ 137,00	1	001950266
8x10-12x13-14x15			
16x18-17x19 mm			
195/BV5	€ 8,00	1	001950070

195FTX

chiavi poligonali doppie diritte a cricchetto con testa a profilo Torx®



	L mm	€		
E6xE8	128	17,00	2	001950406
E10xE12	170	18,00	2	001950410
E14xE18	190	22,00	2	001950414
E20xE24	230	25,00	2	001950420



195FTX/B4	€ 90,00	1	001950501
E6xE8-E10xE12			
E14xE18-E20xE24			
195FTX/BV4	€ 8,00	1	001950520

310

polifusori per saldatura tubi e raccordi in materiale plastico PE, PP, PVC e PVDF

CE



230V-650 Watt
50 Hz+60Hz
Schuko (CEE 777)

	Ø mm	€		
310/1	16÷50	208,00	1	003100001
310/2	16÷63	271,00	1	003100002

310B

matrici per polifusore 310



Ø mm	€		
16	47,00	1	003100016
20	52,00	1	003100020
25	53,00	1	003100025
32	61,00	1	003100032
40	71,00	1	003100040
50	91,00	1	003100050
63	105,00	1	003100063

Beta

310/C4

polifusore con assortimento di 3 matrici



310/C4 € 408,00 1 003100104

310/1+310B: Ø 20-25-32

410x260x82 mm - 4,8 kg

310/C8

polifusore con assortimento di 7 matrici



310/C8 € 626,00 1 003100108

310/2+310B: Ø 16-20-25

32-40-50-63

440x270x120 mm - 7,7 kg

311

termopiastre per saldatura tubi in materiale plastico PE, PP, PVC e PVDF

CE

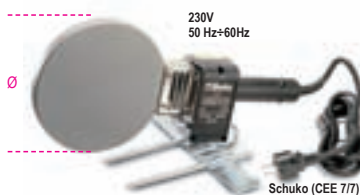

230V
50 Hz+60Hz

Schuko (CEE 777)

	Ø mm	Watt	€		
311/1	120	300	229,00	1	003110001
311/2	190	900	277,00	1	003110002

312A

impugnatura per saldatura a gas



Ø	L mm	€		
M18x1	210	29,00	2	003120001

312B

impugnatura per saldatura a gas con leva comando di flusso rapido



Ø	L mm	€		
M18x1	210	38,00	2	003120005

312F

bruciatori a forcella



	A mm	L mm	kJ/h	€		
312F/40	40	240	24611	20,50	2	003120012

312G

gruppo mazza rame con cuffia e bruciatore Ø 22 mm



	L mm	kJ/h	€		
312G	180	9543	39,00	2	003120041

312G/RM

mazza di ricambio per 312G



	€		
312G/RM	20,00	2	003120046

312G/RC

cuffia di protezione di ricambio per 312G



312G/RC	€ 9,50	2	003120047
---------	--------	---	-----------

312BR

bruciatori in ottone



Ø mm	L mm	kJ/h	€		
10	120	1306	15,00	2	003120051
15	160	7534	19,00	2	003120053
17	160	9041	20,00	2	003120055
20	200	25113	21,00	2	003120057

312BR/A

bruciatori in acciaio



Ø mm	L mm	kJ/h	€		
45	90	46208	9,00	2	003120145
60	110	175791	11,00	2	003120160
90	140	190859	17,00	2	003120190

312PC

prolunghe curve



	L mm	€		
312PC/20	160	12,00	2	003120220
312PC/35	350	13,00	2	003120235
312PC/60	600	15,00	2	003120260
312PC/75	750	16,00	2	003120275

330

tagliatubi per tubi gas in acciaio



	Ø mm -"	L mm	€		
330/2	10÷60 1/8"÷2"	380	114,00	1	003300002
330/4	60÷115 2"÷4"	585	255,00	1	003300004

330R/A

coltelli di ricambio per 330 per tubi in acciaio



	Ø mm	S mm	€		
330R/A2	32	7	10,00	1	003300012
330R/A4	42	9	26,00	1	003300014

330R/I

coltello di ricambio per 330 per acciaio INOX



	Ø mm	€		
330R/I	32	22,00	1	003300024

331L

tagliatubi a cricchetto per rame e leghe leggere



	Ø mm -"	L mm	€		
8÷29 5/16"÷1"1/8"		180	51,00	1	003310008

332

mini-tagliatubi per rame e leghe leggere



	Ø mm -"	L mm	€		
3÷16 1/8"÷5/8"		59	16,00	2	003320001

334

tagliatubi per rame e leghe leggere

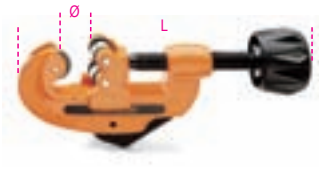

	Ø mm -"	L mm	€		
3÷30 1/8"÷1"1/8"		150	22,00	1	003340001

334R

coltello di ricambio per 332-334 per rame e leghe leggere

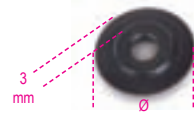

	Ø mm	€		
334R	18	4,00	1	003340021

334R/I

coltello di ricambio per 332-334 per acciaio inox

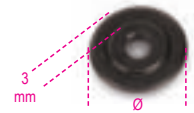

	Ø mm	€		
334R/I	18	13,00	1	003340023

336

tagliatubi ad avanzamento telescopico per rame e leghe leggere



	Ø mm -"	L mm	€		
6÷38 1/4"÷1"1/2"		160	37,00	1	003360001



338

tagliatubi ad avanzamento telescopico rapido per rame, leghe leggere e plastica



Ø mm - "	L mm	€		
6÷67 1/4"÷2"5/8	290	94,00	1	003380001

338R

coltello di ricambio per 336 e 338 per rame e leghe leggere



Ø mm	€		
338R 18,5	4,50	1	003380022

338R/I

coltello di ricambio per 336 e 338 per acciaio inox



Ø mm	€		
338R/I 21,8	14,50	1	003380023

338RP

coltello di ricambio per 336 e 338 per plastica



Ø mm	€		
338RP 21,9	5,00	1	003380025

339A

tagliatubi ad avanzamento telescopico rapido per tubi di plastica



Ø mm - "	L mm	€		
50÷127 2"÷5"	345	192,00	1	003390011

339A/R

coltelli di ricambio per 339A



Ø mm	€		
339A/R 42	13,00	1	003390061

341

pinza tagliatubi per tubi in materiale plastico

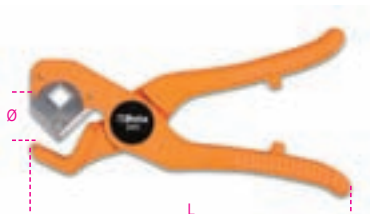

Ø mm	L mm	€		
0÷25	190	24,00	1	003410001

341RL

lama di ricambio per 341



341RL	€		
	10,50	1	003410010

341B

cesoia a cricchetto per tubi in materiale plastico

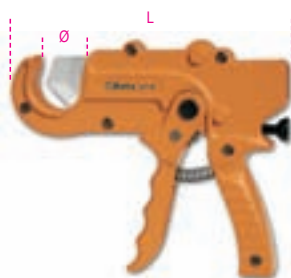

Ø mm	L mm	€		
0÷35	195	52,00	1	003410051

341B/RM

molla di ricambio per 341B

341B/RM	€		
	2,00	1	003410061

341B/RL

lama di ricambio per 341B



341B/RL	€		
	17,50	1	003410060

342

cesoia a cricchetto per tubi in materiale plastico



Ø mm - "	L mm	€		
0÷42 1"5/8	200	34,50	1	003420030

342MOL

molla di ricambio per 342

342MOL	€		
	2,50	1	003420033

342RL

lama di ricambio per 342



342RL	€		
	16,00	1	003420032

342A

cesoia a cricchetto per tubi in materiale plastico



Ø mm - "	L mm	€		
0÷50 2"	270	69,00	1	003420101

342A/MOL

molla di ricambio per 342A

342A/MOL	€		
	1,50	1	003420111

342A/RL

lama di ricambio per 342A



342A/RL	€		
	39,00	1	003420110

342P

cesoia a cricchetto in lega di magnesio per tubi in materiale plastico



Ø mm - "	L mm	€		
0÷50 2"	260	78,00	1	003420121

342P/RL

lama di ricambio per 342P



342P/RL	€		
	34,00	1	003420130

344

pinza allargatubi per tubi di piombo

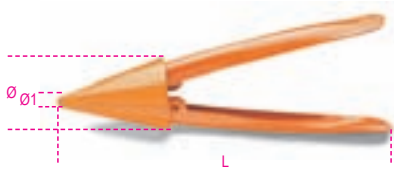

L	Ø	Ø1	€		
240	53	11	30,50	1	003440001

345

utensile sbavatubi corpo in metallo

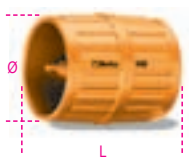

Ø mm - "	L mm	€		
3÷42 1/8"÷1"5/8	58	20,00	5	003450001

345U

utensile sbavatubi per inox, acciaio, rame e leghe leggere



Ø mm - "	L mm	€		
4÷36 5/32÷1"7/16	60	53,00	1	003450050

345SB

sbavatore a raschietto a lama intercambiabile girevole



L mm	€		
150	16,50	5	003450010

345SB/R

lama di ricambio per 345SB



345SB/R	€		
	5,50	3	003450015

349

attrezzo bordatubi con frizione per rame e leghe leggere



Ø mm - "	€		
6-8-10-12-14-15-16-18 (1/8-3/16-1/4-5/16 3/8-1/2-5/8-3/4)	185,00	1	003490001

270x200x50 mm - 2,7 kg

349/SMM

slitta metrica per 349



Ø mm	€		
6-8-10-12-14-15-16-18	57,00	1	003490011

349/SMAS

slitta in pollici per 349



Ø "	€		
1/8-3/16-1/4-5/16 3/8-1/2-5/8-3/4	55,00	1	003490012

350

attrezzo bordatubi per rame e leghe leggere

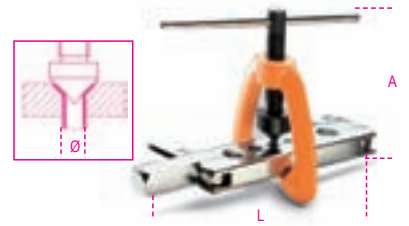

Ø mm	L mm	A mm	€		
4-4,75-6-8 10-12-14	175	104	62,00	1	003500001

351C

tagliatubi ed attrezzo bordatubi



351C	€		
	108,00	1	003510010

334	Ø 3÷30 mm (1/8"÷1"1/8)
350	Ø 4÷14 mm
351P	Ø 4-4,75-6-8-10-12-14 mm

225x150x45 mm - 1,6 kg

351P

puntali per 350



	Ø mm	€		
351P4	4	5,00	5	003510101
351P4,75	4,75	5,00	5	003510102
351P6	6	5,00	5	003510103
351P8	8	5,00	5	003510104
351P10	10	5,00	5	003510105
351P12	12	5,00	5	003510106
351P14	14	5,00	5	003510107

352

attrezzo bordatubi per rame e leghe leggere

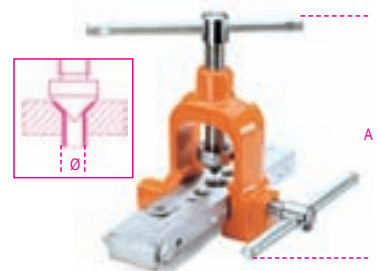

Ø mm	A mm	€		
4,75-5-6-8-10-12-14	124	140,00	1	003520001

352C

tagliatubi ed attrezzo bordatubi



352R/S 003520049

352C € 255,00 1 003520010

334 Ø 3÷30 mm (1/8"÷1"1/8)
 352 Ø 4,75÷14 mm
 352P Ø 4,75x0,7-5x0,7-6x0,7-8x0,7-10x0,7 mm
 Ø 4,75x1-5x1-6x1-8x1-10x1 mm

352PR
 418x160x59 mm - 3,3 kg

352PR

pressore per 352



352PR € 6,50 5 003520050

352P

puntali per 352



	ØxS mm	€		
352P1/0,7	4,75x0,7	5,50	5	003520051
352P2/0,7	5x0,7	5,50	5	003520052
352P3/0,7	6x0,7	5,50	5	003520053
352P4/0,7	8x0,7	5,50	5	003520054
352P5/0,7	10x0,7	5,50	5	003520055
352P1/1	4,75x1,0	5,50	5	003520056
352P2/1	5x1,0	5,50	5	003520057
352P3/1	6x1,0	5,50	5	003520058
352P4/1	8x1,0	5,50	5	003520059
352P5/1	10x1,0	5,50	5	003520060

352U

attrezzo bordatubi regolabile,
per rame e leghe leggere



352U € 68,00 1 003520101

Ø mm - " A mm
 5÷16 130
 3/16÷5/8

352C/U

tagliatubi, sbavatore
ed attrezzo bordatubi regolabile



352C/U € 129,50 1 003520110

334 Ø 3÷30 mm (1/8"÷1"1/8)
 345SB
 352U Ø 5÷16 mm (3/16"÷5/8")
 335x145x60 mm - 2120 g

353N

pinza allargatubi a matrici
ad espansione, intercambiabili



353N € 248,00 1 003530201

L mm
 380

353NM

matrici ad espansione per 353N



Ø mm	€		
10	90,00	1	003530210
12	90,00	1	003530212
14	90,00	1	003530214
16	90,00	1	003530216
18	90,00	1	003530218
22	90,00	1	003530222

353N/C6

pinza allargatubi 353N
con matrici ad espansione 353NM



353N/C6 € 816,00 1 003530300

353N
 353NM Ø 10-12-14-16-18-22 mm
 420x185x60 mm - 2,2 kg

355

chiave per raccordi radiatori
a cinque gradazioni



355 € 52,00 2 003550001

12"
 Ø " L mm
 3/8"-1/2" 90
 3/4"-1"

357F3

dima a tre file
per installazione attacchi sanitari



357F3 € 83,00 1 003570100

Ø " L mm
 3/8" / 1/2" 90÷220

357R/F3

coppia di file di ricambio per 357F3



357 R/F3 € 13,00 1 003570101

358

attrezzi per smussare esternamente
tubi in materiale plastico



358 € 120,00 1 003580001

358/2 € 120,00 1 003580002

Ø mm
 358/1 16÷110
 358/2 40÷250

358RL

lama di ricambio per 358/1 e 358/2



358RL € 22,50 1 003580011

359

chiave universale per pilette



Ø "	L mm	A mm	€	🔧	📦
1"±1/4"	160	140	45,00	1	003590001

359CH

adattatore per pilette
con grata a croce per 359



Ø "	L mm	€	🔧	📦
1"1/2"	74	29,00	1	003590005

360

giratubi modello stillson



L mm	Ø max "	Ø max mm	€	🔧	📦
250	1" gas	34	25,00	1	003600025
350	1"1/2 gas	49	34,00	1	003600035
450	2" gas	60	48,00	1	003600045
600	2"1/2 gas	76	73,00	1	003600060
900	3"1/2 gas	102	208,00	1	003600090

360R/...

kit ricambio per 360
composto da ganaschia mobile e ghiera.

	€	🔧	📦
360R/250	10,00	1	003600225
360R/350	13,50	1	003600235
360R/450	20,00	1	003600245
360R/600	30,00	1	003600260
360R/900	52,00	1	003600290

362

giratubi modello americano



L mm	Ø max "	Ø max mm	€	🔧	📦
200	1" gas	34	23,00	1	003620020
250	1"1/2 gas	49	28,00	1	003620025
300	2" gas	60	34,00	1	003620030
350	2" gas	60	40,00	1	003620035
450	2"1/2 gas	76	60,00	1	003620045
600	3" gas	90	88,00	1	003620060

362R/...

kit ricambi per 362
composto da: ganaschia fissa; ganaschia mobile;
ghiera; spina di fissaggio.

	€	🔧	📦
362R/200	4,50	1	003620220
362R/250	6,00	1	003620225
362R/300	7,00	1	003620230
362R/350	8,50	1	003620235
362R/450	11,50	1	003620245
362R/600	16,00	1	003620260

363

giratubi modello americano
corpo in lega leggera



L mm	Ø max "	Ø max mm	€	🔧	📦
350	2" gas	60	50,00	1	003630035
450	2"1/2 gas	76	65,00	1	003630045
600	3" gas	90	107,00	1	003630060
900	5" gas	140	217,00	1	003630090

363R/...

kit ricambi per 363
composto da: ganaschia fissa; ganaschia mobile;
ghiera; spina di fissaggio.

	€	🔧	📦
363R/350	9,00	1	003630235
363R/450	12,00	1	003630245
363R/600	17,00	1	003630260
363R/900	42,50	1	003630290

365

giratubi modello frontale
corpo in lega leggera



L mm	Ø max "	Ø max mm	€	🔧	📦
350	2" gas	60	59,00	1	003650035
450	2"1/2 gas	76	83,00	1	003650045

365R/...

kit ricambi per 365
composto da: ganaschia fissa; ganaschia mobile;
ghiera; spina di fissaggio.

	€	🔧	📦
365R/350	38,00	1	003650235
365R/450	60,00	1	003650245

366

giratubi tipo leggero



L mm	Ø max "	Ø max mm	€	🔧	📦
175	1" gas	34	21,00	1	003660017
225	1"1/2 gas	49	27,00	1	003660022
275	2" gas	60	31,00	1	003660027
300	2"1/2 gas	76	34,00	1	003660030
350	3" gas	90	40,00	1	003660035

374

giratubi modello svedese
ganasce sottili a 45°



L mm	Ø max "	Ø max mm	€	🔧	📦
240	1/2" gas	21	26,00	1	003740024
320	1" gas	34	35,00	1	003740032
410	1"1/2 gas	49	46,00	1	003740041
550	2" gas	60	73,00	1	003740055
630	3" gas	90	125,00	1	003740063

375

giratubi modello svedese
ganasce parallele a 45°



L mm	Ø max "	Ø max mm	€	🔧	📦
320	1" gas	34	35,00	1	003750032
410	1"1/2 gas	49	46,00	1	003750041
550	2" gas	60	73,00	1	003750055

376

giratubi modello svedese
ganasce piane a 90°



L mm	Ø max "	Ø max mm	€	🔧	📦
320	1" gas	34	35,00	1	003760032
410	1"1/2 gas	49	46,00	1	003760041
550	2" gas	60	73,00	1	003760055
630	3" gas	90	125,00	1	003760063

378

giratubi modello svedese
ganasce sottili a 45°



L mm	Ø max "	Ø max mm	€	🔧	📦
250	1/2" gas	21	29,00	1	003780025
320	1" gas	34	38,00	1	003780032
410	1"1/2 gas	49	50,00	1	003780041
550	2" gas	60	78,00	1	003780055
650	3" gas	90	132,00	1	003780065



374R/...

KIT ricambi completi per 374 - 375 - 376 - 378
composto da ghiera e fermaghiera

	€		
374R/240 374/240-378/250	1,80	1	003740724
374R/320 374/320-375/320-376/320-378/320	2,00	1	003740732
374R/410 374/410-375/410-376/410-378/410	2,20	1	003740741
374R/550 374/550-375/550-376/550-378/550	2,90	1	003740755
374R/630 374/630-378/650	4,00	1	003740763

383

giratubi reversibili a nastro



	€		
383/1 3" gas	39,00	2	003830001
383/2 8" gas	41,00	2	003830002

383R

nastri di ricambio per 383



	€		
383R/1	16,50	1	003830010
383R/2	18,00	1	003830015

384

giratubi reversibile a catena



	€		
4" gas	52,00	1	003840032

384RC

catena di ricambio per 384



	€		
384RC	34,50	1	003840033

386A

giratubi reversibili a catena
modello pesante



	€		
386A/3 4" gas 115 mm	173,00	1	003860003
386A/4 6" gas 168 mm	333,00	1	003860004
386A/5 8" gas 220 mm	432,00	1	003860005
386A/6 12" gas 324 mm	737,00	1	003860006

386A/RC

catene di ricambio per 386A



	€		
386A/3/RC	54,00	1	003860013
386A/4/RC	80,00	1	003860014
386A/5/RC	109,00	1	003860015
386A/6/RC	196,00	1	003860016

388

attrezzi curvatubi
per rame, lega leggera e acciaio dolce

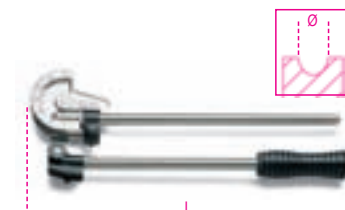

	€		
6	45,00	1	003880006
8	49,00	1	003880008
10	56,00	1	003880010
12	60,00	1	003880012
14	76,00	1	003880014
15	82,00	1	003880015
16	89,00	1	003880016

388A

pinza curvatubi
per rame e lega leggera



	€		
388A/1	45,00	1	003880051
388A/2	45,00	1	003880055

388C/C8

attrezzo curvatubi con 7 matrici
per rame e lega leggera



	€		
388C/C8	335,00	1	003880200

400x330x110 mm - 3,6 kg

392C

pinza regolabile per sifoni



	€		
25+65	26,00	1	003920100

392RG/C

coppia di copriganasce di ricambio per 392C



	€		
392RG/C	4,50	1	003920101

393

pinza per dadi rubinetto



	€		
270	41,00	2	003930001

395

chiave per dadi rubinetto
articolata

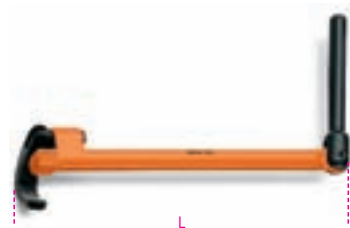

	€		
15+32 mm	31,00	2	003950001
5/8"+1"1/4			

395T

chiave per dadi rubinetto articolata, telescopica



Ø mm	L mm	€	Icona	Icona
10÷32 mm	250÷430	43,00	2	003950100

399

morse ribaltabili da banco

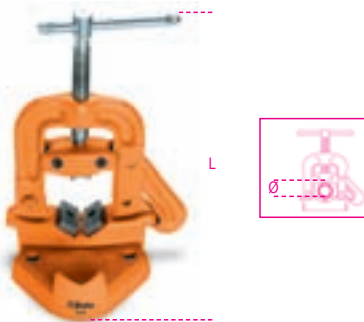

Ø	L min mm	€	Icona	Icona
10÷60 mm	220	120,00	1	003990005
1/8÷2"				
10÷89 mm	290	220,00	1	003990010
1/8÷3"				

410

punte elicoidali cilindriche serie corta, in acciaio HSS rullate



DIN 338 ISO 235

Ø mm	L mm	L1 mm	€	Icona	Icona
0,50	22	6	1,16	10	004100030
1,00	34	12	0,60	10	004100040
1,25	38	16	0,53	10	004100043
1,50	40	18	0,46	10	004100046
1,75	46	22	0,47	10	004100049
2,00	49	24	0,44	10	004100052
2,25	53	27	0,53	10	004100055
2,50	57	30	0,46	10	004100058
2,75	61	33	0,53	10	004100061
3,00	61	33	0,46	10	004100064
3,20	65	36	0,65	10	004100066
3,25	65	36	0,65	10	004100067
3,50	70	39	0,59	10	004100070
3,75	70	39	0,73	10	004100073
4,00	75	43	0,64	10	004100076
4,20	75	43	0,82	10	004100078
4,25	75	43	0,82	10	004100079
4,50	80	47	0,74	10	004100082
4,75	80	47	0,91	10	004100085
5,00	86	52	0,78	10	004100088
5,25	86	52	1,27	10	004100091
5,50	93	57	1,08	10	004100094
5,75	93	57	1,25	10	004100097
6,00	93	57	1,08	10	004100100
6,25	101	63	1,45	10	004100103
6,50	101	63	1,30	10	004100106
6,75	109	69	1,78	10	004100109
7,00	109	69	1,55	10	004100112
7,50	109	69	1,68	10	004100118
8,00	117	75	1,96	10	004100124
8,50	117	75	2,03	10	004100130
9,00	125	81	2,46	5	004100136

Ø mm	L mm	L1 mm	€	Icona	Icona
9,50	125	81	2,74	5	004100142
10,00	133	87	2,96	5	004100148
10,50	133	87	3,65	5	004100172
11,00	142	94	4,25	5	004100184
11,50	142	94	4,50	5	004100196
12,00	151	101	5,05	5	004100210
12,50	151	101	5,40	5	004100222
13,00	151	101	5,65	5	004100234
14,00	160	108	7,60	5	004100242
15,00	169	114	8,95	5	004100250
16,00	178	120	11,10	5	004100258
17,00	186	125	12,30	3	004100262
18,00	194	130	14,40	3	004100266
19,00	202	135	16,50	3	004100270
20,00	210	140	19,40	3	004100274



Modello	Specifiche	€	Icona	Icona
410/SP19	Ø 1÷10 x 0,5 mm	31,00	1	004100419
410/SPV1		17,50	1	004100420
410/SP25		68,00	1	004100425
410/SPV2	Ø 1÷13 x 0,5 mm	24,50	1	004100426



Modello	Specifiche	€	Icona	Icona
410/SEL19	Ø 1÷10 x 0,5 mm	23,00	1	004100418

410MIX/SEL19

serie di 13 punte 410 e 6 punte con inserto in metallo duro



Modello	€	Icona	Icona
410MIX/SEL19	24,50	1	004100417

Ø 1 - 1,5 - 2 - 2,5 - 3 - 3,5 - 4
4,5 - 5 - 5,5 - 6 - 8 - 10 mm

Ø 4 - 5 - 6 - 8 - 9 - 10 mm

410A

punte elicoidali cilindriche serie corta, in acciaio HSS rullate



Ø mm	L mm	L1 mm	€	Icona	Icona
13,50	160	108	9,20	5	004100281
14,00	160	108	9,20	5	004100283
14,50	169	114	10,50	5	004100285
15,00	169	114	10,50	5	004100287
15,50	178	120	12,90	5	004100289
16,00	178	120	12,90	5	004100291
16,50	186	125	13,80	3	004100292
17,00	186	125	13,80	3	004100293
17,50	194	130	16,50	3	004100294
18,00	194	130	16,50	3	004100295
18,50	202	135	17,90	3	004100296
19,00	202	135	17,90	3	004100297
19,50	210	140	21,30	3	004100298
20,00	210	140	21,30	3	004100299

410AS

punte elicoidali cilindriche serie corta, in acciaio HSS rullate



ANSI B94

Ø "	L mm	L1 mm	€	Icona	Icona
1/16	48	22	0,41	10	004100371
5/64	51	25	0,45	10	004100372
3/32	57	32	0,52	10	004100373
7/64	67	38	0,57	10	004100374
1/8	70	41	0,63	10	004100375
9/64	73	44	0,67	10	004100376
5/32	79	51	0,72	10	004100377
11/64	83	54	0,79	10	004100378
3/16	89	59	0,93	10	004100379
13/64	92	62	0,98	10	004100380
7/32	95	64	1,07	10	004100381
15/64	98	67	1,22	10	004100382
1/4	102	70	1,37	10	004100383
17/64	105	73	1,69	10	004100384
9/32	108	75	1,78	10	004100385



Ø "	L mm	L1 mm	€		
19/64	111	78	2,12	10	004100386
5/16	114	81	2,48	10	004100387
21/64	117	84	2,61	10	004100388
11/32	121	87	2,96	5	004100389
23/64	124	89	3,10	5	004100390
3/8	127	92	3,25	5	004100391



410AS/SP21	€ 47,00		1	004100429
Ø 1/16-5/64-3/32-7/64				
1/8-9/64-5/32-11/64-3/16				
13/64-7/32-15/64-1/4				
17/64-9/32-19/64-5/16				
21/64-11/32-23/64-3/8				
410AS/SPV1	€ 17,50		1	004100430



410AS/SEL21	€ 37,50		1	004100433
Ø 1/16-5/64-3/32-7/64				
1/8-9/64-5/32-11/64-3/16				
13/64-7/32-15/64-1/4				
17/64-9/32-19/64-5/16				
21/64-11/32-23/64-3/8				

412

punte elicoidali cilindriche
serie corta, in acciaio HSS
rettificate lucide



DIN 338 ISO 235

Ø mm	L mm	L1 mm	€		
0,50	22	6	2,09	10	004120030
1,00	34	12	1,28	10	004120040
1,25	38	16	1,39	10	004120043
1,50	40	18	1,17	10	004120046
1,75	46	22	1,14	10	004120049
2,00	49	24	0,97	10	004120052
2,25	53	27	1,24	10	004120055
2,50	57	30	1,06	10	004120058
2,75	61	33	1,26	10	004120061
3,00	61	33	1,11	10	004120064
3,25	65	36	1,48	10	004120067
3,50	70	39	1,35	10	004120070
3,75	70	39	1,65	10	004120073
4,00	75	43	1,48	10	004120076
4,25	75	43	1,89	10	004120079

Ø mm	L mm	L1 mm	€		
4,50	80	47	1,72	10	004120082
4,75	80	47	2,09	10	004120085
5,00	86	52	1,84	10	004120088
5,25	86	52	2,69	10	004120091
5,50	93	57	2,45	10	004120094
5,75	93	57	2,98	10	004120097
6,00	93	57	2,62	10	004120100
6,25	101	63	3,75	10	004120103
6,50	101	63	3,30	10	004120106
6,75	109	69	4,30	10	004120109
7,00	109	69	3,95	10	004120112
7,25	109	69	4,85	5	004120115
7,50	109	69	4,10	5	004120118
7,75	117	75	5,40	5	004120121
8,00	117	75	4,90	5	004120124
8,25	117	75	5,95	5	004120127
8,50	117	75	5,90	5	004120130
8,75	125	81	6,75	5	004120133
9,00	125	81	6,20	5	004120136
9,25	125	81	7,45	5	004120139
9,50	125	81	6,60	5	004120142
9,75	133	87	8,35	5	004120145
10,00	133	87	7,00	5	004120148
10,25	133	87	11,00	5	004120149
10,50	133	87	9,70	5	004120150
10,75	142	94	13,20	5	004120151
11,00	142	94	11,60	5	004120152
11,25	142	94	14,10	5	004120153
11,50	142	94	12,30	5	004120154
11,75	142	94	15,40	5	004120155
12,00	151	94	13,30	5	004120156
12,25	151	101	16,80	5	004120157
12,50	151	101	14,50	5	004120158
12,75	151	101	19,00	5	004120159
13,00	151	101	15,30	5	004120160



412/SP19	€ 68,50		1	004120419
Ø 1=10 x 0,5 mm				
412/SPV1	€ 17,00		1	004120420
412/SP25	€ 135,00		1	004120425
Ø 1=13 x 0,5 mm				
412/SPV2	€ 24,00		1	004120426
412/SP49	€ 340,00		1	004120449
Ø 1=13 x 0,25 mm				
412/SPV4	€ 82,00		1	004120451

412/C150



412/C150	€ 404,00		1	004120450
n.				
412	Ø 3 mm			20
	Ø 1 - 1,5 - 2 - 2,5 - 3 - 3,5 - 4 - 4,5 - 5 mm			10
	Ø 5,5 - 6 - 6,5 - 7 - 7,5 - 8 - 8,5 - 9 - 9,5 - 10 mm			5
365x230x47 mm - 3,3 kg				



412/SP91	€ 445,00		1	004120452
Ø 1=10 x 0,10 mm				

412A

punte elicoidali cilindriche
serie corta, in acciaio HSS
rettificate brunite



DIN 338 ISO 235

Ø mm	L mm	L1 mm	€		
13,50	160	108	22,30	3	004120202
14,00	160	108	23,30	3	004120204
14,50	169	114	24,40	3	004120206
15,00	169	114	26,50	3	004120208
15,50	178	120	29,50	3	004120210
16,00	178	120	30,50	3	004120212
16,50	186	125	33,00	1	004120213
17,00	186	125	34,00	1	004120214
17,50	194	130	38,00	1	004120215
18,00	194	130	39,00	1	004120216
18,50	202	135	42,50	1	004120217
19,00	202	135	43,50	1	004120218
19,50	210	140	50,00	1	004120219
20,00	210	140	51,00	1	004120220

412L

punte elicoidali cilindriche
serie lunga, in acciaio HSS
rettificate brunite



Ø mm	L mm	L1 mm	€		
2,00	85	56	2,46	10	004120232
2,50	95	62	2,66	10	004120234
3,00	100	66	2,72	10	004120236
3,50	112	73	3,15	10	004120238
4,00	119	78	3,40	10	004120240
4,50	126	82	4,10	10	004120242
5,00	132	87	4,35	10	004120244
5,50	139	91	5,45	10	004120246
6,00	139	91	5,85	10	004120248
6,50	148	97	7,00	5	004120250
7,00	156	102	8,15	5	004120252
8,00	165	109	10,90	5	004120256
9,00	175	115	12,80	5	004120260
10,00	184	121	14,00	5	004120264

414

punte elicoidali cilindriche
serie corta, in acciaio HSS-TiN
rettificate



DIN 338 ISO 235

Ø mm	L mm	L1 mm	€	📦	🚚
1,00	34	12	1,68	10	004140040
1,25	38	16	2,17	10	004140042
1,50	40	18	1,68	10	004140046
1,75	46	22	2,17	10	004140048
2,00	49	24	1,68	10	004140052
2,25	53	27	2,17	10	004140054
2,50	57	30	1,68	10	004140058
2,75	61	33	2,55	10	004140060
3,00	61	33	1,98	10	004140064
3,25	65	36	2,55	10	004140066
3,50	70	39	2,08	10	004140070
3,75	70	39	2,61	10	004140072
4,00	75	43	2,15	10	004140076
4,25	75	43	3,10	10	004140078
4,50	80	47	2,40	10	004140082
4,75	80	47	3,45	10	004140084
5,00	86	52	2,75	10	004140088
5,25	86	52	4,60	10	004140090
5,50	93	57	3,55	10	004140094
5,75	93	57	4,60	10	004140096
6,00	93	57	3,65	10	004140100
6,25	101	63	5,65	10	004140102
6,50	101	63	4,30	10	004140106
6,75	109	69	6,70	10	004140108
7,00	109	69	5,15	10	004140112
7,25	109	69	6,90	5	004140114
7,50	109	69	5,70	5	004140118
7,75	117	75	7,85	5	004140120
8,00	117	75	6,30	5	004140124
8,25	117	75	8,65	5	004140125
8,50	117	75	6,80	5	004140130
8,75	125	81	10,40	5	004140132
9,00	125	81	8,50	5	004140136
9,25	125	81	11,50	5	004140138
9,50	125	81	9,30	5	004140142
9,75	133	87	12,20	5	004140144
10,00	133	87	10,00	5	004140148
10,50	133	87	12,00	5	004140150
11,00	142	94	14,80	5	004140152
11,50	142	94	14,80	5	004140154
12,00	151	101	17,40	5	004140156
12,50	151	101	19,90	5	004140158
13,00	151	101	19,90	5	004140160



	€	📦	🚚
414/SP19 Ø 1÷10 x 0,5 mm	94,00	1	004140419
414/SPV1 Ø 1÷13 x 0,5 mm	17,00	1	004140420
414/SP25 Ø 1÷13 x 0,5 mm	195,00	1	004140425
414/SPV2 Ø 1÷13 x 0,25 mm	24,00	1	004140426
414/SP49 Ø 1÷13 x 0,25 mm	410,00	1	004140429
414/SPV4	80,00	1	004140430

414/C116



414/C116 € 374,00 📦 1 🚚 004140450

414	Ø 1 - 1,5 - 2 - 2,5 - 3 - 3,5 - 4 - 4,5 - 5 mm	n.
	Ø 5,5 - 6 - 6,5 - 7 - 7,5 - 8 mm	3
	Ø 8,5 - 9 - 9,5 - 10 mm	2

365x230x47 mm - 📦 2,7 Kg

415

punte elicoidali cilindriche
serie corta, in acciaio HSS-CO 8%
rettificate



DIN 338 ISO 235

Ø mm	L mm	L1 mm	€	📦	🚚
0,50	22	6	4,70	10	004150029
1,00	34	12	2,25	10	004150040
1,25	38	16	2,54	10	004150043
1,50	40	18	2,27	10	004150046
1,75	46	22	2,41	10	004150049
2,00	49	24	2,17	10	004150052
2,25	53	27	2,67	10	004150055
2,50	57	30	2,36	10	004150058
2,75	61	33	2,67	10	004150061
3,00	61	33	2,36	10	004150064
3,25	65	36	3,40	10	004150067
3,50	70	39	3,05	10	004150070
3,75	70	39	3,90	10	004150073
4,00	75	43	3,35	10	004150076
4,25	75	43	4,35	10	004150079
4,50	80	47	3,95	10	004150082
4,75	80	47	4,55	10	004150085
5,00	86	52	4,20	10	004150088
5,25	86	52	6,15	10	004150091
5,50	93	57	5,60	10	004150094
5,75	93	57	6,40	10	004150097
6,00	93	57	5,80	10	004150100
6,25	101	63	8,05	10	004150103
6,50	101	63	7,15	10	004150106
6,75	109	69	9,60	10	004150109
7,00	109	69	8,50	10	004150112
7,25	109	69	10,30	5	004150115
7,50	109	69	9,20	5	004150118
7,75	117	75	11,90	5	004150121
8,00	117	75	10,80	5	004150124
8,25	117	75	13,00	5	004150127
8,50	117	75	11,70	5	004150130
8,75	125	81	16,10	5	004150133
9,00	125	81	14,00	5	004150136
9,25	125	81	16,70	5	004150139
9,50	125	81	15,40	5	004150142
9,75	133	87	18,40	5	004150145
10,00	133	87	16,10	5	004150148
10,25	133	87	21,70	5	004150149
10,50	133	87	18,40	5	004150150
10,75	142	94	24,20	5	004150151
11,00	142	94	21,10	5	004150152
11,25	142	94	27,00	5	004150153
11,50	142	94	23,00	5	004150154
11,75	142	94	28,00	5	004150155
12,00	151	101	25,50	5	004150156
12,25	151	101	32,50	5	004150157
12,50	151	101	27,50	5	004150158
12,75	151	101	36,00	5	004150159
13,00	151	101	30,00	5	004150160

Ø mm	L mm	L1 mm	€	📦	🚚
14,00	160	108	52,00	3	004150164
15,00	169	114	62,50	3	004150168
16,00	178	120	76,50	3	004150172
17,00	186	125	87,00	1	004150174
18,00	194	130	96,50	1	004150176
19,00	202	135	111,50	1	004150178
20,00	210	140	124,00	1	004150180



415/SP19 € 133,00 📦 1 🚚 004150419

415/SPV1 € 17,00 1 004150420

415/SP25 € 275,00 1 004150425

415/SPV2 € 24,00 1 004150426

415/SP49 € 680,00 1 004150431

415/SPV4 € 81,00 1 004150432

415/C116



415/C116 € 553,00 📦 1 🚚 004150450

415	Ø 1 - 1,5 - 2 - 2,5 - 3 - 3,5 - 4 - 4,5 - 5 mm	n.
	Ø 5,5 - 6 - 6,5 - 7 - 7,5 - 8 mm	3
	Ø 8,5 - 9 - 9,5 - 10 mm	2

365x230x47 mm - 📦 2,7 kg



415/SP91 € 790,00 📦 1 🚚 004150460

Ø 1÷10 x 0,10 mm

416

punta cilindrica con affilatura speciale a doppia coppia di taglienti



VELOCITÀ DI TAGLIO SUPERIORE

DIN 338

Ø mm	L mm	L1 mm	€		
1,00	34	12	1,80	10	004160010
1,50	40	18	1,80	10	004160015
2,00	49	24	1,80	10	004160020
2,50	57	30	1,86	10	004160025
3,00	61	33	1,92	10	004160030
3,50	70	39	2,24	10	004160035
4,00	75	43	2,48	10	004160040
4,50	80	47	2,72	10	004160045
5,00	86	52	3,10	10	004160050
5,50	93	57	3,95	10	004160055
6,00	93	57	4,35	10	004160060
6,50	101	63	5,10	10	004160065
7,00	109	69	5,95	10	004160070
7,50	109	69	6,40	5	004160075
8,00	117	75	7,55	5	004160080
8,50	117	75	8,15	5	004160085
9,00	125	81	9,65	5	004160090
9,50	125	81	10,20	5	004160095
10,00	133	87	11,80	5	004160100

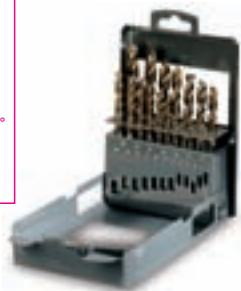
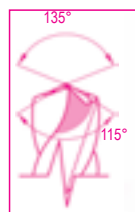

416/SP19
Ø 1÷10 x 0,5 mm

€ 90,00 1 004160419

417

punte elicoidali cilindriche per muratura serie corta, in acciaio fresato con placchetta in metallo duro



DIN 8039

Ø mm	L mm	€		
3	70	2,35	10	004170003
4	75	2,40	10	004170004
5	85	2,65	10	004170005
5L	150	5,85	5	004170105
6	100	2,70	10	004170007
6L	150	5,85	5	004170106
7	120	2,90	10	004170009
8	120	3,20	10	004170010
8L	200	6,30	5	004170113
9	120	3,80	10	004170011
10	120	4,50	10	004170012
10L	200	7,60	5	004170120
12	150	6,25	10	004170014
12L	200	8,15	5	004170125
14	150	8,60	5	004170016
16	150	10,20	5	004170018



417/SP8
Ø 3-4-5-6-8-9-10-12 mm

€ 35,00 1 004170100

419

punte per muratura corpo fresato con placchetta in metallo duro



DIN 8039

ØxL mm	€		
4x110	5,05	10	004190002
5x110	5,05	10	004190004
5x160	5,65	10	004190006
6x110	5,05	10	004190012
6x160	5,35	10	004190014
6x210	7,45	10	004190016
7x160	6,05	10	004190028
8x110	5,35	10	004190030
8x160	5,70	10	004190032
8x210	7,05	10	004190034
8x260	9,65	10	004190036
8x460	22,00	10	004190042
9x160	7,30	5	004190044
10x160	7,10	5	004190050
10x210	8,55	5	004190052
10x260	10,60	5	004190054
10x310	15,20	5	004190056
10x460	23,30	5	004190060
12x160	8,15	5	004190064
12x210	11,00	5	004190066
12x260	11,80	5	004190068
12x460	24,30	5	004190074
14x160	10,40	3	004190086
14x260	13,70	3	004190090
14x310	19,60	3	004190092
14x460	25,00	3	004190096
16x210	16,60	3	004190112
16x250	17,60	3	004190114
16x300	21,10	3	004190116
16x450	28,50	3	004190120
18x250	22,80	1	004190124
20x310	23,50	1	004190128

423

punte speciali per punti di saldatura in acciaio HSS, rettificato



Ø mm	L mm	€		
6	66	13,10	10	004230006
7	74	16,20	10	004230007
8	79	17,60	10	004230008
10	89	20,40	10	004230010

423A

frese speciali per punti di saldatura, in acciaio HSS rettificato



DIN 1412/E

Ø mm	L mm	€		
6,5	40	18,20	1	004230015
8,0	40	20,00	1	004230020

424

punte coniche per forare ed allargare in acciaio HSS

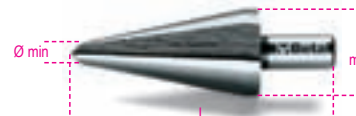

	L mm	Ø mm	€		
424/1	58	3÷14	22,70	3	004240001
424/2	63	6÷20	38,50	3	004240002
424/3	60	16÷30	63,50	3	004240003
424/4	80	3÷22	74,00	1	004240004
424/5	102	3÷31	98,00	1	004240005
424/6	86	26÷40	129,00	1	004240006
424/7	89	36÷50	199,00	1	004240007
424/8	90	40÷61	324,00	1	004240008



424/SP3
424/1+424/2+424/3

€ 128,50 1 004240019

Ø 3÷30 mm

424/SPV € 34,50 1 004240020

425

frese coniche a gradino in acciaio HSS

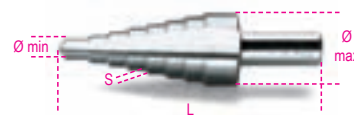

	L mm	Ø mm	S mm	€		
425/1	70	4÷12	1	35,50	2	004250010
425/2	55	4÷12	2	38,00	2	004250012
425/3	85	4÷20	2	56,00	2	004250015
425/4	85	12÷20	1	98,00	1	004250016
425/5	97	20÷30	1	155,00	1	004250017
425/6	75	4÷30	2	116,50	1	004250020
425/7	97	30÷40	1	233,50	1	004250025
425/8	100	40÷50	1	337,00	1	004250029



425/SP3	€ 210,00	1	004250030
425/1+425/3+425/6			
Ø 4÷30 mm			
425/SPV	€ 34,50	1	004250035

426

frese a sbavare ed incassare
a tre taglienti
in acciaio HSS



DIN 335-C

GR	Ø mm	L mm	€		
1	4,3	44	15,40	5	004260001
2	5,3	44	15,40	5	004260002
3	6,3	44	16,10	5	004260003
4	7,3	44	18,20	5	004260004
5	8,3	50	18,20	5	004260005
6	9,4	50	20,50	5	004260006
7	10,4	54	21,70	5	004260007
8	12,4	54	23,10	5	004260008
9	15,0	56	27,00	5	004260009
10	16,5	60	27,50	5	004260010
11	20,5	63	40,00	5	004260011
12	25,0	66	60,00	5	004260012
13	28,0	71	79,00	5	004260013
14	31,0	71	83,00	5	004260014



426/SP6	€ 168,00	1	004260030
GR 3-5-7-8-10-11			
Ø 6,3÷20,5 mm			
426/SPV	€ 34,50	1	004260035

426SB

frese a sbavare e svasare
in acciaio HSS



	L mm	Ø1 mm	€		
426/SB1	45	10 - (2÷5)	16,00	1	004260101
426/SB2	48	14 - (5÷10)	20,50	1	004260102
426/SB3	65	21 - (10÷15)	39,00	1	004260103
426/SB4	85	28 - (15÷20)	70,00	1	004260104
426/SB5	102	35 - (20÷25)	127,00	1	004260105
426/SB6	115	44 - (25÷30)	195,00	1	004260106



426SB/SP4	€ 173,50	1	004260130
426/SB1-426/SB2			
426/SB3-426/SB4			
Ø 2÷20 mm			
426SB/SPV1	€ 34,50	1	004260135

426MD

lime rotative in metallo duro

taglio incrociato HM4



	L mm	Ø mm	€		
426MD/CP8	63	8	31,00	1	004260512
426MD/CP12	70	12	47,00	1	004260522
426MD/CT8	63	8	31,00	1	004260513
426MD/CT12	70	12	47,00	1	004260523
426MD/F8	63	8	31,00	1	004260514
426MD/F12	70	12	47,00	1	004260524
426MD/T8	63	8	31,00	1	004260516
426MD/T12	70	12	47,00	1	004260526
426MD/S8	52	8	31,00	1	004260518
426MD/S12	55	12	47,00	1	004260528
426MD/FA8	63	8	31,00	1	004260519
426MD/FA12	70	12	47,00	1	004260529



426MD/SP10	€ 340,00	1	004260510
426MD/CP-426MD/CT-426MD/F			
426MD/T-426MD/S			
Ø 8-12 mm			

427

estrattori coni Morse



DIN 317

GR	L mm	A mm	€		
0	92	13	6,50	5	004270000
1-2	140	19	6,60	5	004270002
3	190	25	9,80	5	004270003
4	225	30	16,50	3	004270004
5-6	260	35	30,00	3	004270006

428FP

maschi a macchina per fori passanti
passo grosso
in acciaio HSS



ISO 529

M	■ mm	L mm	L1 mm	€		
3x0,5	2,7	56	11	12,90	10	004280003
4x0,7	3,4	63	13	12,90	10	004280004
5x0,8	4,9	70	16	12,90	10	004280005
6x1	4,9	80	19	13,60	10	004280006
8x1,25	6,2	90	22	16,30	10	004280008
10x1,5	8,0	100	24	19,00	10	004280010
12x1,75	9,0	110	29	23,60	5	004280012
14x2	7,0	110	30	29,50	5	004280014
16x2	9,0	110	30	36,00	5	004280016
18x2,5	11,0	125	34	49,50	3	004280018
20x2,5	12,0	140	34	52,00	3	004280020
22x2,5	14,5	140	34	62,50	3	004280022
24x3	14,5	160	38	68,50	3	004280024

Beta

EST. 1950

428FC

maschi a macchina per fori ciechi
passo grosso
in acciaio HSS



ISO 529

M	■ mm	L mm	L1 mm	€	🔧	📦
3x0,5	2,7	56	11	15,10	10	004280103
4x0,7	3,4	63	13	15,10	10	004280104
5x0,8	4,9	70	16	15,10	10	004280105
6x1	4,9	80	19	15,80	10	004280106
8x1,25	6,2	90	22	17,20	10	004280108
10x1,5	8,0	100	24	20,70	10	004280110
12x1,75	7,0	110	29	25,50	5	004280112
14x2	9,0	110	30	33,00	5	004280114
16x2	9,0	110	30	40,00	5	004280116
18x2,5	11,0	125	34	52,50	3	004280118
20x2,5	12,0	140	34	58,00	3	004280120
22x2,5	14,5	140	34	71,00	3	004280122
24x3	14,5	160	38	76,50	3	004280124

428/C14

assortimento di 14 maschi a macchina
428FP+428FC



428/C14	283,00	1	004280201
428FP M3÷12			
428FC M3÷12			
428/SPV	13,00	1	004280202

429FP

maschi a macchina per fori passanti
passo grosso
in acciaio HSS-CO 5%



ISO 529

M	■ mm	L mm	L1 mm	€	🔧	📦
3x0,5	2,7	56	11	17,00	5	004290003
4x0,7	3,4	63	13	17,00	5	004290004
5x0,8	4,9	70	16	17,00	5	004290005
6x1	4,9	80	19	18,40	5	004290006
8x1,25	6,2	90	22	20,50	5	004290008
10x1,5	8,0	100	24	24,20	5	004290010
12x1,75	7,0	110	29	31,00	5	004290012
14x2	9,0	110	30	37,00	5	004290014

429FC

maschi a macchina per fori ciechi
passo grosso
in acciaio HSS-CO 5%



ISO 543

M	■ mm	L mm	L1 mm	€	🔧	📦
3x0,5	2,7	56	11	21,30	5	004290103
4x0,7	3,4	63	13	21,30	5	004290104
5x0,8	4,9	70	16	21,30	5	004290105
6x1	4,9	80	19	21,90	5	004290106
8x1,25	6,2	90	22	23,90	5	004290108
10x1,5	8,0	100	24	31,00	5	004290110
12x1,75	7,0	110	29	37,00	5	004290112
14x2	9,0	110	30	45,00	5	004290114

429/C14

assortimento di 14 maschi a macchina
429FP+429FC



429/C14	353,00	1	004290201
429FP M3÷12			
429FC M3÷12			
428/SPV	13,00	1	004280202

430

serie di 3 maschi a mano
sgrossatore, intermedio, finitore
passo grosso, in acciaio al cromo



ISO 543

M	■ mm	L mm	L1 mm	€	🔧	📦
2x0,4	2,5	36	11	9,90	5	004300002
3x0,5	2,5	40	12	6,90	5	004300003
4x0,7	3,0	45	14	6,90	5	004300004
5x0,8	4,0	48	16	7,20	5	004300005
6x1	5,0	50	18	7,20	5	004300006
7x1	4,5	50	18	9,40	5	004300007
8x1,25	5,0	56	22	9,40	3	004300008
9x1,25	5,5	63	22	12,40	3	004300009
10x1,5	6,0	70	25	12,10	3	004300010
11x1,5	7,0	70	25	15,80	3	004300011
12x1,75	7,0	75	30	15,20	3	004300012
14x2	8,0	80	32	19,80	3	004300014
16x2	10,0	80	32	23,40	3	004300016
18x2,5	11,0	95	40	31,50	1	004300018
20x2,5	12,0	95	40	37,50	1	004300020
22x2,5	14,5	100	40	45,00	1	004300022
24x3	14,5	110	50	52,00	1	004300024



430/SP21	91,50	1	004300201
M 3-4-5-6-8-10-12			
430/SPV	49,00	1	004300202

430ASW

serie di 3 maschi a mano
sgrossatore, intermedio, finitore
Whitworth, in acciaio al cromo



DIN 352

BSW	■ mm	L mm	L1 mm	€	🔧	📦
1/8x40	2,7	40	12	6,80	5	004300031
5/32x32	3,4	45	14	6,80	5	004300032
3/16x24	4,3	48	18	6,95	5	004300033
1/4x20	4,9	50	22	7,85	5	004300034
5/16x18	4,9	56	25	9,70	3	004300035
3/8x16	5,5	70	28	12,80	3	004300036
7/16x14	6,2	70	30	14,40	3	004300037
1/2x12	7,0	75	32	15,80	3	004300038
9/16x12	9,0	80	32	19,90	1	004300039
5/8x11	9,0	80	38	24,00	1	004300040
3/4x10	11,0	95	40	34,50	1	004300041
7/8x9	14,5	100	40	43,00	1	004300042
1"x8	16,0	110	50	55,50	1	004300043

430ASC

serie di 3 maschi a mano
sgrossatore, intermedio, finitore
UNC, in acciaio al cromo

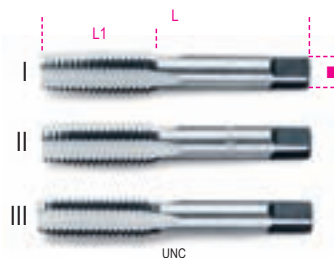

ANSI B1.1

UNC	■ mm	L mm	L1 mm	€	🔧	📦
1/4x20	4,9	70	30	10,20	5	004300051
5/16x18	4,9	70	30	13,40	5	004300052
3/8x16	5,5	75	35	14,90	3	004300053
7/16x14	6,2	80	40	18,90	3	004300054
1/2x13	7,0	85	45	24,80	3	004300055
9/16x12	9,0	90	45	29,00	3	004300056
5/8x11	9,0	100	47	34,50	3	004300057
3/4x10	11,0	110	50	47,00	3	004300058
7/8x9	14,5	120	60	53,50	1	004300059
1"x8	16,0	130	60	60,00	1	004300060

431

serie di 3 maschi a mano
sgrossatore, intermedio, finitore
passo grosso, in acciaio HSS

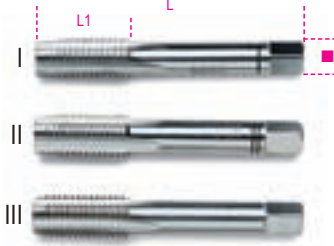

DIN 352 UNI 4535

M	mm	L	L1	€		
3x0,5	2,5	40	12	15,50	5	004310003
4x0,7	3,0	45	14	15,50	5	004310004
5x0,8	4,0	48	16	15,50	5	004310005
6x1	5,0	50	18	15,50	5	004310006
7x1	5,0	50	18	21,50	5	004310007
8x1,25	5,0	56	22	18,20	3	004310008
10x1,5	6,0	70	25	22,90	3	004310010
12x1,75	7,0	75	30	30,00	3	004310012
14x2	9,0	80	32	41,00	1	004310014
16x2	9,0	80	32	48,50	1	004310016
18x2,5	11,0	95	40	71,00	1	004310018
20x2,5	12,0	95	40	76,00	1	004310020
22x2,5	12,0	100	40	105,00	1	004310022
24x3	14,5	110	50	120,00	1	004310024



431/SP21	175,00	1	004310201
M 3-4-5-6-8-10-12			
431/SPV	41,00	1	004310202

433

serie di 2 maschi a mano
sgrossatore e finitore
passo fine, in acciaio al cromo

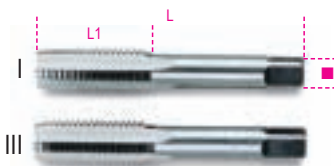

DIN 2181 UNI 4535

M	mm	L	L1	€		
6x0,75	4,5	48	16	6,25	5	004330201
7x0,75	4,5	56	18	7,45	5	004330202
8x0,75	5,0	50	16	7,45	5	004330203
8x1	5,0	56	16	7,45	5	004330204
9x0,75	6,0	63	22	9,70	5	004330205
9x1	6,0	63	22	9,70	5	004330206
10x0,75	6,5	63	18	9,70	5	004330207
10x1	6,5	63	18	9,70	5	004330208
10x1,25	6,5	63	18	9,70	5	004330209
11x0,75	7,0	70	25	13,10	3	004330210
11x1	7,0	70	25	13,10	3	004330211
11x1,25	7,0	70	25	13,10	3	004330212
12x0,75	7,0	70	20	12,80	3	004330213
12x1	7,0	70	20	12,80	3	004330214
12x1,25	7,0	70	20	12,80	3	004330215
12x1,5	7,0	70	20	12,80	3	004330216
14x1	8,0	80	32	16,70	1	004330217

433ASF

serie di 2 maschi a mano
UNF, passo fine
in acciaio al cromo

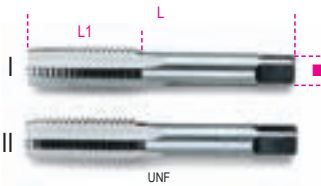

ANSI B.1.1

UNF	mm	L	L1	€		
1/4x28	4,9	70	30	7,60	5	004330301
5/16x24	4,9	70	30	8,90	5	004330302
3/8x24	5,5	75	35	9,80	3	004330303
7/16x20	6,2	80	40	13,00	3	004330304
1/2x20	7,0	85	45	16,50	3	004330305
9/16x18	9,0	90	45	20,30	3	004330306
5/8x18	9,0	100	47	23,20	3	004330307
3/4x16	11,0	110	50	31,50	3	004330308
7/8x14	14,5	120	60	40,50	1	004330309
1"x12	16,0	130	60	56,00	1	004330310

433ASG

serie di 2 maschi a mano
filettatura **GAS** cilindrica
in acciaio al cromo

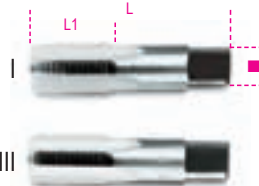

DIN 353 UNI 338

GAS	mm	L	L1	€		
1/8x28	4,9	65	18	10,70	1	004330401
1/4x19	5,5	70	24	13,60	1	004330402
3/8x19	6,2	75	25	16,70	1	004330403
1/2x14	7,0	80	31	24,00	1	004330405
3/4x14	9,0	90	33	39,50	1	004330408
1"x11	11,0	100	39	63,50	1	004330410

434

serie di 2 maschi a mano
sgrossatore e finitore
passo fine, in acciaio HSS

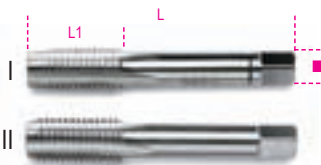

DIN 2181 UNI 4535

M	mm	L	L1	€		
6x0,75	4,5	48	16	20,30	5	004340001
8x0,75	5,0	56	16	21,70	5	004340003
8x1	5,0	56	16	21,70	5	004340004
10x0,75	6,5	63	18	28,50	5	004340007
10x1	6,5	63	18	28,50	5	004340008

M	mm	L	L1	€		
10x1,25	6,5	63	18	28,50	5	004340009
12x1	7,0	70	20	29,50	3	004340014
12x1,25	7,0	70	20	29,50	3	004340015
12x1,5	7,0	70	20	29,50	3	004340016
13x1,5	9,0	70	20	85,00	1	004340017
14x1	9,0	70	20	36,00	1	004340018
14x1,25	9,0	70	20	36,00	1	004340019
14x1,5	9,0	70	20	29,50	1	004340020
15x1,5	9,0	70	20	85,00	1	004340021
16x1	9,0	70	20	40,00	1	004340022
16x1,5	9,0	70	20	34,00	1	004340023
18x1,5	11,0	80	22	42,00	1	004340024
18x2	11,0	90	25	54,50	1	004340025
20x1,25	12,0	80	22	85,00	1	004340026
20x1,5	12,0	80	22	47,00	1	004340027
20x2	12,0	90	25	60,50	1	004340028
22x1,5	14,5	80	22	63,00	1	004340029
24x1	14,5	80	22	91,00	1	004340030
24x1,5	14,5	80	22	72,00	1	004340031
24x2	14,5	80	22	76,00	1	004340032

435

giramaschi regolabili
corpo in acciaio

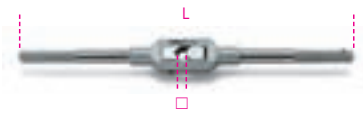

DIN 1814

	mm	L	€		
435/0	2÷5	140	12,00	3	004350007
	M2÷M8				
435/1	2÷6	180	15,00	2	004350009
	M3÷M10				
435/1,5	2,5÷6	180	16,00	2	004350011
	M3÷M12				
435/2	3÷7	260	21,00	2	004350013
	M4÷M12				
435/3	4÷12	380	32,50	1	004350020
	M5÷M20				
435/4	5,5÷16	490	58,00	1	004350027
	M9÷M27				
435/5	7÷18	620	128,00	1	004350032
	M13÷M32				

435G

giramaschi regolabili
corpo in lega leggera



DIN 1814

	mm	L	€		
435G/0	2÷5	130	8,80	5	004350108
	M1÷M8				
435G/1	2÷6	190	10,20	5	004350110
	M1÷M10				
435G/1,5	2÷7	175	11,00	5	004350112
	M2÷M12				
435G/2	3,4÷7	280	17,80	5	004350114
	M4÷M12				
435G/3	4,9÷12	380	28,50	2	004350121
	M5÷M20				
435G/4	7÷16	500	45,50	2	004350127
	M11÷M27				
435G/5	7÷18	700	72,00	1	004350132
	M13÷M32				
435G/6	11÷24	800	118,00	1	004350142
	M18÷M42				

Beta

436

giramaschi a cricchetto
reversibile

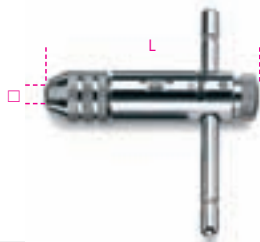

	□ mm	L mm	€		
436/1	2÷5 M3÷M8	85	20,00	5	004360002
436/2	4,6÷8 M5÷M12	110	26,00	5	004360004

436L

giramaschi a cricchetto
reversibile, tipo lungo



	□ mm	L mm	€		
436L/1	2÷5 M3÷M8	245	32,00	2	004360012
436L/2	4,6÷8 M5÷M12	295	38,00	2	004360014

436R

morsetti di ricambio per 436 e 436L

436R/1	€ 3,50	1	004360022
436R/2	€ 4,00	1	004360024

437C

set ripristino filettature candela danneggiate,
M14x1,25 mm

• altezza elicoidi: 8,40 - 12,40 - 16,40 mm. (5 pz per misura)



437C	€ 85,00	1	004370100
------	---------	---	-----------

437C/...

elicoidi in acciaio inossidabile per 437C



H mm	€		
8.4	21,00	1	004370108
12.4	21,00	1	004370112
16.4	21,00	1	004370116

I prezzi indicati sono relativi a 10 pezzi

437C/RM14

maschi filetti candele M14x1,25



437C/RM14	€ 70,00	1	004370124
-----------	---------	---	-----------

437U/09

assortimento per il ripristino delle filettature
danneggiate



25 x M5, M6, M8, M10
10 x M12

437U/09	€ 225,00	1	004370550
M5X0,8			
M6X1,0			
M8X1,25			
M10X1,5			
M12X1,75			

370x230x55 mm - 2 Kg

437U/E-M...

elicoidi in acciaio inossidabile



H mm	€		
M5	7.5	13,00	1 004370555
M6	9	13,00	1 004370556
M8	12	18,00	1 004370558
M10	15	24,00	1 004370560
M12	18	15,00	1 004370562

I prezzi indicati sono relativi a 25 pezzi
(10 per la misura M12)

437U/PM

punte e maschi per 437U/09



	€		
M5	25,00	1	004370565
M6	26,50	1	004370566
M8	35,00	1	004370568
M10	45,00	1	004370570
M12	56,00	1	004370572

438A

serie di punte per forare, filettare e svasare; in
acciaio HSS

• M3 - M4 - M5 - M6 - M8 - M10
• con portainseri magnetico



438A	€ 81,00	1	004380010
------	---------	---	-----------

438...

punte per forare, filettare e svasare

in acciaio HSS, attacco 1/4"

1/4



	S max mm	€		
M3	3	16,00	2	004380103
M4	4	16,00	2	004380104
M5	5	16,00	2	004380105
M6	6	16,00	2	004380106
M8	8	18,00	2	004380108
M10	10	18,00	2	004380110

440

filiere tonde **passo grosso**
in acciaio al cromo



DIN 223 UNI EN 22568

M	Ø mm	€		
2x0,4	25,4	11,80	5	004400002
3x0,5	25,4	8,85	5	004400003
4x0,7	25,4	8,85	5	004400004
5x0,8	25,4	7,50	5	004400005
6x1	25,4	7,50	5	004400006
7x1	25,4	7,50	5	004400007
8x1,25	25,4	7,50	5	004400008
9x1,25	25,4	7,50	5	004400009
10x1,5	25,4	7,50	5	004400010
12x1,75	25,4	7,50	5	004400012

440A

filiere tonde **passo grosso**
in acciaio al cromo



UNI EN 22568

M	Ø mm	€		
10x1,5	38,1	10,60	3	004400110
11x1,5	38,1	10,60	3	004400111
12x1,75	38,1	10,60	3	004400112
14x2	38,1	10,60	3	004400114
16x2	38,1	10,60	3	004400116
18x2,5	38,1	12,00	3	004400118
20x2,5	38,1	13,50	3	004400120

440B

filiere tonde **passo grosso**
in acciaio al cromo



UNI EN 22568

M	Ø mm	€		
18x2,5	50,8	19,20	3	004400122
20x2,5	50,8	19,80	3	004400124
22x2,5	50,8	21,30	3	004400126
24x3	50,8	21,80	3	004400128

440ASW

filiere tonde **Whitworth**
in acciaio al cromo



BSW	Ø mm	€		
1/8x40	25,4	10,00	5	004400201
5/32x32	25,4	10,00	5	004400202
3/16x24	25,4	9,05	5	004400203
1/4x20	25,4	9,05	5	004400204
5/16x18	25,4	9,05	5	004400205
3/8x16	38,1	12,70	3	004400206
7/16x14	38,1	12,70	3	004400207
1/2x12	38,1	12,90	3	004400208
9/16x12	38,1	12,90	3	004400209
5/8x11	50,8	23,30	3	004400210
3/4x10	50,8	23,30	3	004400211
7/8x9	50,8	27,00	3	004400212
1"x8	50,8	27,00	3	004400213

440ASC

filiere tonde, **UNC**
passo grosso, in acciaio al cromo



UNC	Ø mm	€		
1/4x20	25,4	9,05	5	004400221
5/16x18	25,4	9,05	5	004400222
3/8x16	38,1	12,40	3	004400223
7/16x14	38,1	12,40	3	004400224
1/2x13	38,1	12,60	3	004400225
9/16x12	38,1	12,60	3	004400226
5/8x11	50,8	26,50	3	004400227
3/4x10	50,8	26,50	3	004400228
7/8x9	50,8	26,50	3	004400229
1"x8	50,8	26,50	3	004400230

440ASF

filiere tonde, **UNF**
passo fine, in acciaio al cromo



ANSI B1.1

UNF	Ø mm	€		
1/4x28	25,4	9,45	5	004400241
5/16x24	25,4	9,45	5	004400242
3/8x24	38,1	13,30	3	004400243
7/16x20	38,1	13,30	3	004400244
1/2x20	38,1	13,50	3	004400245
9/16x18	38,1	13,50	3	004400246
5/8x18	50,8	28,00	3	004400247
3/4x16	50,8	28,00	3	004400248
7/8x14	50,8	28,00	3	004400249
1"x12	50,8	28,00	3	004400250

440ASG

filiere tonde, filettatura **GAS** cilindrica
in acciaio al cromo



UNI EN 22568

GAS	Ø mm	€		
1/8x28	38,1	10,60	3	004400255
1/4x19	38,1	10,60	3	004400256
3/8x19	38,1	10,60	3	004400257
1/2x14	50,8	21,90	3	004400259
3/4x14	50,8	21,90	3	004400260
1"x11	63,5	44,00	3	004400261

441

filiere tonde **passo fine**
in acciaio al cromo



DIN EN 22568

M	Ø mm	€		
6x0,75	25,4	8,85	5	004410004
7x0,75	25,4	8,85	5	004410005
8x0,75	25,4	8,85	5	004410006
8x1	25,4	8,85	5	004410007
9x0,75	25,4	8,85	5	004410008
9x1	25,4	8,85	5	004410009

441A

filiere tonde **passo fine**
in acciaio al cromo



DIN 223 UNI EN 22568

M	Ø mm	€		
10x0,75	38,1	13,50	3	004410100
10x1	38,1	13,50	3	004410101
10x1,25	38,1	13,50	3	004410102
11x0,75	38,1	13,50	3	004410103
11x1	38,1	13,50	3	004410104
11x1,25	38,1	13,50	3	004410105
12x0,75	38,1	13,50	3	004410106
12x1	38,1	13,50	3	004410107
12x1,25	38,1	13,50	3	004410108
12x1,5	38,1	13,50	3	004410109
14x1	38,1	13,50	3	004410110
14x1,25	38,1	13,50	3	004410111
14x1,5	38,1	13,50	3	004410112
16x1	38,1	13,50	3	004410113
16x1,5	38,1	13,50	3	004410114
18x1,5	38,1	13,50	3	004410115



441B

filiere tonde **passo fine**
in acciaio al cromo



DIN 223 UNI EN 22568

M	Ø mm	€		
18x1,5	50,8	25,00	3	004410117
18x2	50,8	25,00	3	004410118
20x1,5	50,8	26,50	3	004410119
22x1,5	50,8	26,50	3	004410120
24x1,5	50,8	26,50	3	004410121
24x2	50,8	26,50	3	004410122

442

filiere tonde **passo grosso**
in acciaio HSS



DIN 223 UNI EN 22568

M	ØxS mm	€		
3x0,5	20x5	11,90	3	004420003
4x0,7	20x5	11,90	3	004420004
5x0,8	20x7	11,90	3	004420005
6x1	20x7	11,90	3	004420006
7x1	25x9	12,80	3	004420007
8x1,25	25x9	12,80	3	004420008
10x1,5	30x11	15,60	3	004420010
12x1,75	38x14	22,90	3	004420012
14x2	38x14	29,00	1	004420014
16x2	45x18	37,50	1	004420016
18x2,5	45x18	39,50	1	004420018
20x2,5	45x18	41,50	1	004420020
22x2,5	55x22	56,00	1	004420022
24x3	55x22	57,00	1	004420024

443

filiere tonde, **passo fine**
in acciaio HSS



UNI EN 22568

M	ØxS mm	€		
6x0,75	20x7	21,30	1	004430107
8x0,75	25x9	23,20	1	004430110
8x1	25x9	21,30	1	004430111
10x0,75	30x11	26,00	1	004430113
10x1	30x11	24,80	1	004430114
10x1,25	30x11	24,80	1	004430115
12x1	38x10	38,00	1	004430116
12x1,25	38x10	38,00	1	004430117
12x1,5	38x10	38,00	1	004430118
13x1,5	38x10	49,00	1	004430119
14x1	38x10	38,00	1	004430120
14x1,25	38x10	38,00	1	004430121
14x1,5	38x10	38,00	1	004430122
15x1,5	38x10	51,00	1	004430123
16x1	45x14	55,00	1	004430124
16x1,5	45x14	55,00	1	004430125
18x1,5	45x14	55,00	1	004430127

M	ØxS mm	€		
20x1,25	45x14	58,00	1	004430129
20x1,5	45x14	58,00	1	004430130
20x2	45x14	63,00	1	004430131
22x1,5	55x16	68,00	1	004430132
24x1	55x16	68,00	1	004430133
24x1,5	55x16	70,00	1	004430135
24x2	55x16	75,00	1	004430136

444

girafiliera, corpo in acciaio



DIN 225

	Ø mm	L mm	€		
444	20x5	215	17,00	5	004440005
444/0	20x7	215	17,00	5	004440007
444/1	25,4	225	17,00	5	004440025
444/1A	25x9	225	17,00	5	004440027
444/1B	30x11	300	17,00	5	004440030
444/C	38x10	315	22,00	3	004440033
444/1C	38x14	315	22,00	3	004440035
444/2	38,1x14	360	22,00	3	004440038
444/1D	45x14	455	32,00	1	004440045
444/2D	45x18	455	32,00	1	004440046
444/3	50,8	555	46,00	1	004440050
444/4	55x16	555	46,00	1	004440055
444/5A	63,5	630	77,00	1	004440057

444G

girafiliera, corpo in lega leggera



UNI EN 22568

	Ø mm	L mm	€		
444G/A	16x5	160	7,00	5	004440103
444G	20x5	200	7,00	5	004440105
444G/0	20x7	200	7,00	5	004440107
444G/1	25,4	210	9,00	5	004440125
444G/1A	25x9	224	9,00	5	004440127
444G/1B	30x11	280	12,00	5	004440130
444G/C	38x10	315	18,00	3	004440133
444G/1C	38x14	315	18,00	3	004440135
444G/2	38,1	320	18,00	3	004440138
444G/1D	45x14	450	23,00	1	004440145
444G/2D	45x18	450	24,00	1	004440146
444G/3	50,8	500	25,00	1	004440150
444G/4	55x16	560	30,00	1	004440155
444G/5A	63,5	620	53,00	1	004440163
444G/6	65x18	630	55,00	1	004440165

446/C30

assortimento di maschi e filiere,
in acciaio al cromo e accessori
in cassetta di legno



446/C30 € 220,00 1 004460055

325x220x35 mm - 3,2 Kg

430 M mm	440 M mm		
3x0,5	3x0,5	435/1,5	444/1
4x0,7	4x0,7		
5x0,8	5x0,8		
6x1	6x1		
8x1,25	8x1,25		
10x1,5	10x1,5		
12x1,75	12x1,75		

446/C48

assortimento di maschi e filiere,
in acciaio al cromo e accessori
in cassetta di legno



446/C48 € 410,00 1 004460057

580x300x50 mm - 5 Kg

430 M mm	440 M mm	440A M mm		
3x0,5	3x0,5	10x1,5	435/1	444/1
4x0,7	4x0,7	12x1,75	435/3	444/2
5x0,8	5x0,8	14x2		
6x1	6x1	16x2		
8x1,25	8x1,25	18x2,5		
10x1,5		20x2,5		
12x1,75				
14x2				
16x2				
18x2,5				
20x2,5				

446/C110

assortimento di maschi e filiere, in acciaio al cromo e accessori per autoriparazione in cassetta di legno



446/C110 € 620,00 1 004460060

500x337x60 mm - 8,1 Kg

430 M	433 M	440/440A, 441/441A M	441A M
2x0,4	6x0,75	2x0,4	6x0,75
3x0,5	7x0,75	3x0,5	7x0,75
4x0,7	8x0,75	4x0,7	8x0,75
5x0,8	8x1	5x0,8	8x1
6x1	9x0,75	6x1	9x0,75
7x1	9x1	7x1	9x1
8x1,25	10x0,75	8x1,25	10x0,75
9x1,25	10x1	9x1,25	10x1
10x1,5	10x1,25	10x1,5	10x1,25
11x1,5	11x0,75	11x1,5	11x0,75
12x1,75	11x1	12x1,75	11x1
14x2	11x1,25	14x2	11x1,25
16x2	12x0,75	16x2	12x0,75
	12x1		12x1
	12x1,25		12x1,25
	12x1,5		12x1,5
	14x1		14x1
	14x1,25		14x1,25
	14x1,5		14x1,5
	16x1		16x1
	16x1,5		16x1,5
	18x1,5		18x1,5

435/0	444/1	436/1
435/3	444/2	

446ASF/C29

assortimento di maschi e filiere in acciaio al cromo e accessori filettatura UNF in cassetta di legno



446ASF/C29 € 445,00 1 004460070

660x410x50 mm - 6 Kg

433ASF	440ASF		
1/4	1/4	435/1,5	444/1
5/16	5/16	435/3	444/2
3/8	3/8		444/3
7/16	7/16		
1/2	1/2		
9/16	9/16		
5/8	5/8		
3/4	3/4		

446ASW/C36

assortimento di maschi e filiere in acciaio al cromo e accessori filettatura Whitworth in cassetta di legno



446ASW/C36 € 380,00 1 004460075

525x310x50 mm - 3,4 Kg

430ASW	440ASW		
1/8	1/8	435/1,5	444/1
5/32	5/32	435/2	444/2
3/16	3/16		
1/4	1/4		
5/16	5/16		
3/8	3/8		
7/16	7/16		
1/2	1/2		

446ASC/C37

assortimento di maschi e filiere in acciaio al cromo e accessori filettatura UNC in cassetta di legno



446ASC/C37 € 495,00 1 004460080

660x410x50 mm - 6,7 Kg

430ASC	440ASC		
1/4	1/4	435/1,5	444/1
5/16	5/16	435/3	444/2
3/8	3/8		444/3
7/16	7/16		
1/2	1/2		
9/16	9/16		
5/8	5/8		
3/4	3/4		

446ASG/C23

assortimento di maschi e filiere in acciaio al cromo e accessori filettatura GAS cilindrica in cassetta di legno



446ASG/C23 € 755,00 1 004460085

700x430x70 mm - 9,8 Kg

433ASG	440ASG		
1/8	1/8	435/3	444/2
1/4	1/4	435/5	444/3
3/8	3/8		444/5A
1/2	1/2		
3/4	3/4		
1"	1"		

Beta

ISO 9001

447/C37

assortimento di maschi e filiere in acciaio HSS e accessori in cassetta di metallo



447/C37 € 474,00 1 004470055

380x185x35 mm - 3,9 Kg

431 M	442 M		
3x0,5	3x0,5	435/0	444
4x0,7	4x0,7	435/2	444/0
5x0,8	5x0,8		444/1A
6x1	6x1		444/1B
8x1,25	8x1,25		444/1C
10x1,5	10x1,5		
12x1,75	12x1,75		

436/1	0,5x3x75
-------	----------

447/C53

assortimento di maschi e filiere in acciaio HSS e accessori in cassetta di metallo



447/C53 € 970,00 1 004470060

500x235x50 mm - 9 Kg

431 M	442 M			
3x0,5	3x0,5	435/1,5	444	436/1
4x0,7	4x0,7	435/3	444/0	
5x0,8	5x0,8		444/1A	
6x1	6x1		444/1B	
8x1,25	8x1,25		444/1C	
10x1,5	10x1,5		444/2D	
12x1,75	12x1,75			
14x2	14x2			
16x2	16x2			
18x2,5	18x2,5			
20x2,5	20x2,5			

447/C70

assortimento di maschi e filiere in acciaio HSS e accessori per autoriparazione ed industria in cassetta di legno



447/C70 € 1.200,00 1 004470065

510x340x70 mm - 7,5 Kg

431 M	434 M	442 M	443 M
3x0,5	8x1	3x0,5	8x1
4x0,7	10x1,25	4x0,7	10x1,25
5x0,8	12x1,25	5x0,8	12x1,25
6x1	12x1,5	6x1	12x1,5
7x1	14x1,25	7x1	14x1,25
8x1,25	14x1,5	8x1,25	14x1,5
10x1,5	16x1,5	10x1,5	16x1,5
12x1,75		12x1,75	
14x2		14x2	
16x2		16x2	

435/0	444	436/1
435/3	444/0	
	444/1A	
	444/1B	
	444/1C	
	444/1D	

450

seghe a tazza in acciaio HSS-Co 8%

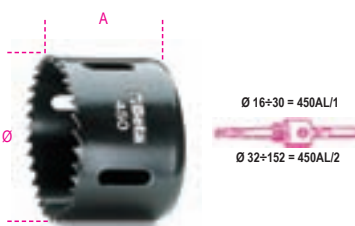

HSS-Co 8%

Ø mm	Ø	A mm	€		
16	(5/8)	57	13,50	1	004500016
17	(11/16)	57	13,50	1	004500017
19	(3/4)	51	13,50	1	004500019
20	-	51	13,50	1	004500020
21	(13/16)	51	13,50	1	004500021
22	(7/8)	51	13,50	1	004500022
24	(15/16)	51	13,50	1	004500024
25	(1")	51	14,00	1	004500025
27	(1 1/16)	51	14,00	1	004500027
29	(1 1/8)	51	14,00	1	004500029
30	(1 3/16)	51	14,00	1	004500030
32	(1 1/4)	51	14,00	1	004500032
33	(1 5/16)	51	14,00	1	004500033
35	(1 3/8)	51	16,70	1	004500035
37	(1 7/8)	51	16,70	1	004500037
38	(1 1/2)	44	16,70	1	004500038

Ø mm	Ø	A mm	€		
40	(1 9/16)	44	17,30	1	004500040
41	(1 5/8)	44	17,30	1	004500041
43	(1 11/16)	44	17,30	1	004500043
44	(1 3/4)	44	19,30	1	004500044
46	(1 13/16)	44	19,30	1	004500046
48	(1 7/8)	44	19,30	1	004500048
51	(2")	44	19,30	1	004500051
52	(2 1/16)	44	22,70	1	004500052
54	(2 1/8)	44	22,70	1	004500054
57	(2 1/4)	44	22,70	1	004500057
59	(2 5/16)	44	22,70	1	004500059
60	(2 3/8)	44	22,70	1	004500060
64	(2 1/2)	44	24,80	1	004500064
65	(2 9/16)	44	24,80	1	004500065
67	(2 5/8)	44	24,80	1	004500067
68	-	44	24,80	1	004500068
70	(2 3/4)	44	24,80	1	004500070
73	(2 7/8)	44	24,80	1	004500073
76	(3")	44	25,50	1	004500076
79	(3 1/8)	44	25,50	1	004500079
83	(3 1/4)	44	25,50	1	004500083
86	(3 3/8)	44	25,50	1	004500086
89	(3 1/2)	44	25,50	1	004500089
92	(3 5/8)	44	27,50	1	004500092
95	(3 3/4)	44	33,50	1	004500095
98	(3 7/8)	44	34,00	1	004500098
102	(4")	44	35,50	1	004500102
105	(4 1/8)	44	38,00	1	004500105
108	(4 1/4)	44	51,50	1	004500108
111	(4 3/8)	44	59,50	1	004500111
114	(4 1/2)	44	70,00	1	004500114
121	(4 3/4)	44	77,50	1	004500121
127	(5")	44	85,50	1	004500127
140	(5 1/2)	44	103,00	1	004500140
152	(6")	44	120,00	1	004500152

450AL

alberi per seghe a tazza

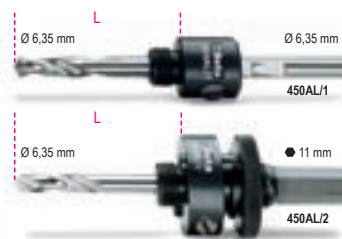

	Ø mm	L mm	€		
450AL/1	16÷30	54	14,90	1	004500210
450AL/2	32÷152	70	38,50	1	004500215

450AD

adattatore per alberi 450AL/1



	Ø mm	€		
450AD	32÷51	5,95	1	004500230



450PA/1

punta per centrare
in acciaio HSS
per alberi 450AL/1



ØxL
mm
6,35x105 € 8,25 1 004500252

450PA/2

punta per centrare
in acciaio HSS
per alberi 450AL/2

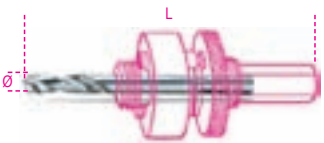

ØxL
mm
6,35x80 € 8,25 1 004500253

450PR

prolunga per seghe a tazza



L
mm
305 € 28,00 1 004500255

450/C9

assortimento di seghe a tazza
ed accessori per elettricisti



HSS-Co 8%

450/C9 € 194,00 1 004500305

450 Ø 22 - 29 - 35 - 44 - 51 - 64 mm
450AL /1 - /2
450AD
420x160x60 mm - 1,1 Kg

450/C13

assortimento di seghe a tazza
ed accessori per installatori



HSS-Co 8%

450/C13 € 240,00 1 004500310

450 Ø 19 - 22 - 29 - 35 - 38
44 - 51 - 57 - 64 mm
450AL /1 - /2
450PA/1
450AD
215x180x65 mm - 1,4 Kg

450/C21

assortimento di seghe a tazza
ed accessori per uso industriale



HSS-Co 8%

450/C21 € 522,00 1 004500315

450 Ø 19 - 22 - 29 - 35 - 38
44 - 51 - 57 - 64 - 76
83 - 92 - 95 - 105 - 114 mm
450AL /1 - /2
450PA /1 - /2
450PR
450AD
420x280x60 mm - 5,2 Kg

451

frese a tazza
in acciaio HSS
interamente rettificate

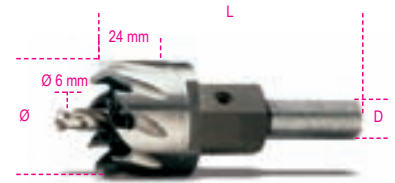

Ø mm	L mm	D mm	€		
12	85	8	17,60	1	004510012
13	85	8	17,60	1	004510013
14	85	8	17,60	1	004510014
15	85	10	17,60	1	004510015
16	85	10	17,60	1	004510016
17	85	10	17,60	1	004510017
18	85	10	17,60	1	004510018
19	85	10	17,60	1	004510019
20	85	10	19,20	1	004510020
21	85	10	20,10	1	004510021
22	85	10	20,80	1	004510022
23	85	10	22,10	1	004510023
24	85	10	22,70	1	004510024
25	85	10	23,40	1	004510025
26	90	10	24,70	1	004510026
27	90	10	25,00	1	004510027
28	90	10	26,00	1	004510028
29	90	10	27,00	1	004510029
30	90	10	27,50	1	004510030
31	90	10	28,50	1	004510031
32	90	10	29,50	1	004510032
33	90	10	31,00	1	004510033
34	90	10	32,00	1	004510034
35	90	10	32,50	1	004510035
36	85	10	33,50	1	004510036
37	85	10	34,50	1	004510037
38	85	10	35,00	1	004510038
39	85	10	37,00	1	004510039
40	85	10	37,50	1	004510040
41	85	10	39,00	1	004510041
42	85	10	39,50	1	004510042
43	85	10	41,00	1	004510043
44	85	10	42,00	1	004510044
45	85	10	42,50	1	004510045
46	85	10	43,50	1	004510046
47	85	10	44,50	1	004510047
48	85	10	46,50	1	004510048
49	85	10	48,00	1	004510049
50	85	10	48,00	1	004510050

451GA

gambi per frese a tazza 451



M	Ø mm	L mm	D mm	€		
10x1,25	12÷14	57	8	9,85	1	004510101
12x1,25	15÷34	57	10	9,85	1	004510102
14x1,5	35÷50	57	10	12,40	1	004510105

451PA

punta pilota per frese a tazza 451
in acciaio HSS



Ø
mm
6 L
mm
53 € 5,25 1 004510103



451PR

prolunga per frese a tazza 451



M	Ø mm	L mm	Ø1 mm	€	🔧	📦
12x1,25	15÷34	400	13	44,00	1	004510104
14x1,5	35÷50	400	13	43,50	1	004510108

452

frese a tazza
con inserti in metallo duro

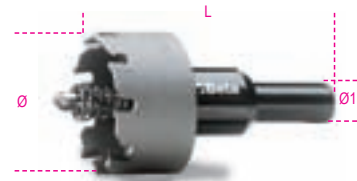

Ø mm	Ø1 mm	L mm	€	🔧	📦
15	10	90	72,00	1	004520015
16	10	90	72,00	1	004520016
17	10	90	72,00	1	004520017
18	10	90	72,00	1	004520018
19	10	90	72,00	1	004520019
20	10	90	72,00	1	004520020
21	10	95	72,00	1	004520021
22	10	95	72,00	1	004520022
23	10	95	72,00	1	004520023
24	10	95	72,00	1	004520024
25	10	95	72,00	1	004520025
26	10	95	81,50	1	004520026
27	10	95	81,50	1	004520027
28	10	95	81,50	1	004520028
29	10	95	81,50	1	004520029
30	10	95	81,50	1	004520030
31	10	95	97,00	1	004520031
32	10	95	97,00	1	004520032
33	10	95	97,00	1	004520033
34	10	95	97,00	1	004520034
35	10	95	97,00	1	004520035
36	10	95	113,00	1	004520036
37	10	95	113,00	1	004520037
38	10	95	113,00	1	004520038
39	13	95	113,00	1	004520039
40	13	95	113,00	1	004520040
41	13	95	127,50	1	004520041
42	13	95	127,50	1	004520042
43	13	95	127,50	1	004520043
44	13	95	127,50	1	004520044
45	13	95	127,50	1	004520045
46	13	95	144,00	1	004520046
47	13	95	144,00	1	004520047
48	13	95	144,00	1	004520048
49	13	95	144,00	1	004520049
50	13	90	144,00	1	004520050
55	13	90	162,00	1	004520055
60	13	90	214,00	1	004520060
65	13	90	214,00	1	004520065
70	13	95	251,00	1	004520070
75	13	95	272,00	1	004520075
80	13	95	293,00	1	004520080
85	13	95	345,00	1	004520085
90	13	95	355,00	1	004520090

452GA

gambi per frese a tazza 452



	Ø mm	€	🔧	📦
452GA/1	15÷21	8,90	1	004520125
452GA/2	22÷38	10,50	1	004520126
452GA/3	39÷100	12,00	1	004520127

560/C2

moltiplicatore di coppia e accessori
rapporto 5:1
in cassetta di plastica

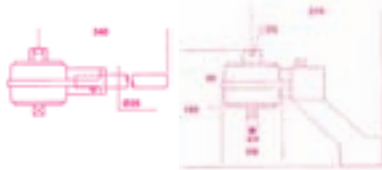

Nm	Kgfm	lbf.ft	□	■	kg
1300	130	960	1/2"	3/4"	3,8

	€	🔧	📦
560/C2	1.255,00	1	005600020
560/2	950,00	1	005600002
560/18	28,00	1	005600018
560/19	58,00	1	005600019
560/22	205,00	1	005600022

≡ 310x275x120 mm

560/C4+

moltiplicatore di coppia
rapporto 5:1
con piede di reazione

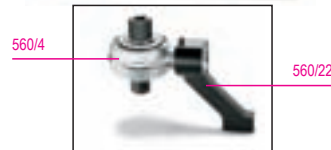

Nm	Kgfm	lbf.ft	□	■	kg
2700	270	2000	3/4"	1"	5

	€	🔧	📦
560/C4+	1.245,00	1	005600042
560/4	998,00	1	005600004
560/18	28,00	1	005600018
560/22	205,00	1	005600022

≡ 310x275x120 mm

560/C6

moltiplicatori di coppia destrorsi/sinistrorsi in
valigetta di materiale plastico
rapporto 6,5:1



Nm	kgfm	lbf.ft	□	■	kg
1500	150	1106	1/2"	3/4"	6

	€	🔧	📦
560/C6	660,00	1	005600160

≡ 400x260x110 mm

560/C12

moltiplicatori di coppia destrorsi/sinistrorsi in
valigetta di materiale plastico
rapporto 12:1



Nm	kgfm	lbf.ft	□	■	kg
2500	250	1844	1/2"	1"	7

	€	🔧	📦
560/C12	960,00	1	005600210

≡ 400x260x110 mm

561

moltiplicatore di coppia
rapporto 5:1



Nm	Kgfm	lbf.ft	□	■	kg
1000	100	740	1/2"	3/4"	4,6

	€	🔧	📦
561	2.700,00	1	005610001

562/1 - 562/2

moltiplicatori di coppia
rapporto 5:1

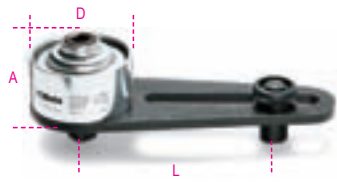

Nm	Kgfm	lbf.ft	□	■	D	A	L min	L max	kg
1700	170	1250	3/4	1"	108	95	85	220	5,3

562/1 € 1.990,00 1 005620001

Nm	Kgfm	lbf.ft	□	■	D	A	L min	L max	kg
3400	340	2500	3/4	1"	119	115	85	265	7,0

562/2 € 2.450,00 1 005620002

564/3R - 564/4R

moltiplicatori di coppia
rapporto 25:1
con dispositivo antiritorno



Nm	Kgfm	lbf.ft	□	■	D	A	L	kg
3000	300	2200	1/2	1"	108	188	155	9,2

564/3R € 4.100,00 1 005640003

Nm	Kgfm	lbf.ft	□	■	D	A	L	kg
6000	600	4500	1/2	1 1/2"	119	235	200	15,5

564/4R € 4.980,00 1 005640004

565/1R - 565/2R - 565/3R

moltiplicatori di coppia
rapporto 25:1
con dispositivo antiritorno



Nm	Kgfm	lbf.ft	□	■	D	A	L min	L max	kg
1700	170	1250	1/2	1"	108	125	80	215	7,7

565/1R € 3.380,00 1 005650011

Nm	Kgfm	lbf.ft	□	■	D	A	L min	L max	kg
3400	340	2500	1/2	1"	119	145	85	265	10,1

565/2R € 4.480,00 1 005650012

Nm	Kgfm	lbf.ft	□	■	D	A	L min	L max	kg
3400	340	2500	1/2	1 1/2"	119	145	85	265	10,7

565/3R € 4.780,00 1 005650013

565/4R

moltiplicatore di coppia
rapporto 25:1
con dispositivo antiritorno

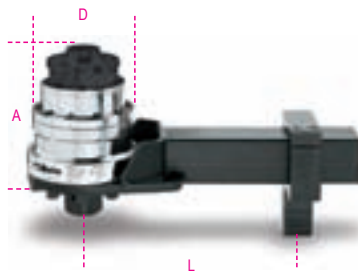

Nm	Kgfm	lbf.ft	□	■	D	A	L min	L max	kg
6000	600	4500	1/2	1 1/2"	144	180	125	335	17

565/4R € 5.280,00 1 005650014

565/5R

moltiplicatore di coppia
rapporto 25:1
con dispositivo antiritorno

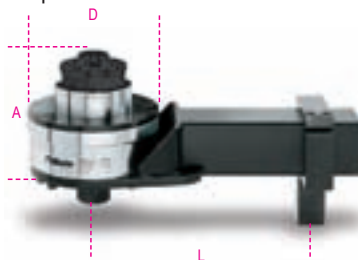

Nm	Kgfm	lbf.ft	□	■	D	A	L min	L max	kg
9500	950	7000	3/4	1 1/2"	184	180	155	355	25

565/5R € 9.580,00 1 005650015

567/4R

moltiplicatore di coppia
rapporto 125:1
con dispositivo antiritorno

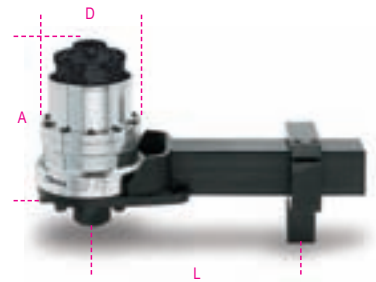

Nm	Kgfm	lbf.ft	□	■	D	A	L min	L max	kg
6000	600	4500	1/2	1 1/2"	144	210	125	335	19

567/4R € 5.980,00 1 005670014

567/5R

moltiplicatore di coppia
rapporto 125:1
con dispositivo antiritorno

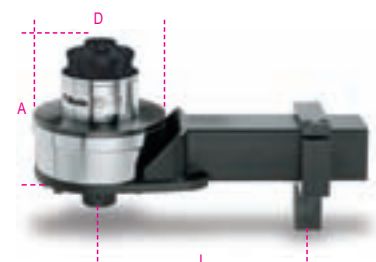

Nm	Kgfm	lbf.ft	□	■	D	A	L min	L max	kg
9500	950	7000	1/2	1 1/2"	184	210	155	350	27

567/5R € 10.550,00 1 005670015

581

giravite dinamometrico a slittamento,
non graduato
adatto a serraggi destrorsi e sinistrorsi,
precisione di serraggio +/-6%
(per il settaggio della coppia usare
gli artt. 588 - 682)



UNI EN 26789
ISO 6789

Nm	gfm	□	kg
1,2÷6	120÷600	1/4"	275

581 € 180,00 1 005810001



583

giravite dinamometrico a slittamento
adatto a serraggi destrorsi e sinistrorsi,
precisione di serraggio +/-6%



UNI EN 26789
ISO 6789

Nm	gfm	lbf.in	kg
0,3÷1,5	30÷150	1/4"	200

583/1,5 € 225,00 1 005830015

Nm	gfm	lbf.in	kg
0,6÷3	60÷300	1/4"	230

583/3 € 225,00 1 005830030

Nm	gfm	lbf.in	kg
1,2÷6	120÷600	1/4"	350

583/6 € 225,00 1 005830060



583/C31

1 giravite dinamometrico, 8 chiavi a bussola
esagonali, 20 inserti per avvitatori e 2
accessori

1/4"



583/C31 € 317,00 1 005830931

	583/6	1.2 - 6 Nm
	900	4-5-5,5-6-7-8-9-10 mm
	860LP	0,6x4,5 - 1x5,5 - 1,2x6,5 mm
	860PH	PH1 - PH2 (x2) - PH3
	860PE	2-2,5-3-4-5 mm
	860TX	T9-T10-T15-T20-T25-T27-T30-T40
	882P/80	80 mm
	892/0	● 1/4 ■ 1/4

270x120x45 mm - 1,2 kg

588

misuratore di coppia elettronico digitale

per la verifica e il settaggio dei giravite dinamometrici artt.
581-583



Nm	lbf.in	lbf.ft	kg
1÷10	10÷90	1/4"	2

588 € 1.490,00 1 005880001

**Tabella dei campi di impiego
delle chiavi e barre dinamometriche
a fine listino**

590 ÷ 592/4

chiavi dinamometriche a lettura diretta
adatte a serraggi destrorsi e sinistrorsi
precisione di serraggio ± 4%

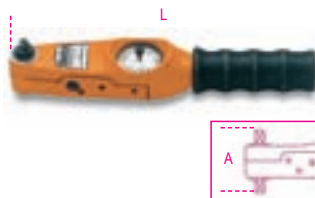

UNI EN 26789
ISO 6789

Nm	Kgfm	lbf.in	lbf.ft	A mm	L mm	kg
0,3÷4	0,03÷0,4	3÷35	1/4	60	253	0,52

590 € 530,00 1 005900001

Nm	Kgfm	lbf.in	lbf.ft	A mm	L mm	kg
0,5÷13,5	0,05÷1,35	4÷120	1/4	60	253	0,52

590/1 € 530,00 1 005900003

Nm	Kgfm	lbf.in	lbf.ft	A mm	L mm	kg
1÷27	0,1÷2,7	10÷240	3/8	70	253	0,52

592/3 € 530,00 1 005920005

Nm	Kgfm	lbf.in	lbf.ft	A mm	L mm	kg
3÷40	0,3÷4	20÷360	3/8	70	253	0,52

592/4 € 530,00 1 005920007



594/8 - 594/21

chiavi dinamometriche a lettura diretta
adatte a serraggi destrorsi e sinistrorsi
precisione di serraggio ± 4%

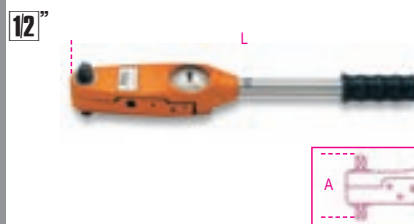

UNI EN 26789
ISO 6789

Nm	Kgfm	lbf.ft	lbf.in	A mm	L mm	kg
6÷80	0,6÷8	5÷60	1/2	85	455	1,35

594/8 € 800,00 1 005940011

Nm	Kgfm	lbf.ft	lbf.in	A mm	L mm	kg
20÷215	2÷21,5	15÷160	1/2	85	530	1,40

594/21 € 795,00 1 005940015

**Servizio di taratura
dinamometrica
a fine listino**

596/80SL - 598/200SL

chiavi dinamometriche a lettura diretta
adatte a serraggi destrorsi e sinistrorsi
precisione di serraggio ± 4%

Il raggiungimento della coppia prefissata
viene segnalato da una luce
e da un suono intermittente

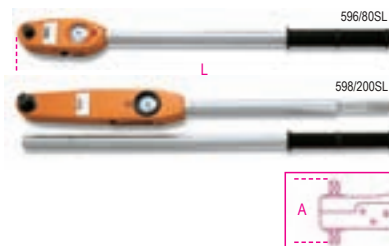

UNI EN 26789
ISO 6789

Nm	Kgfm	lbf.ft	lbf.in	A mm	L mm	kg
40÷800	4÷80	20÷600	3/4	115	1025	4,85

596/80SL € 1.650,00 1 005960020

Nm	Kgfm	lbf.ft	lbf.in	A mm	L mm	kg
200÷2000	20÷200	150÷1500	1"	135	1930	16,70

598/200SL € 3.500,00 1 005980022

599DGT

chiave dinamometrica elettronica con cricchetto reversibile, per serraggi destrorsi e sinistrorsi precisione di serraggio +/- 2% destrorso, +/- 3% sinistrorso

il raggiungimento della coppia prefissata viene segnalato da avvisatori luminosi e da un suono intermittente

• Alimentazione con 2 batterie da 1,5V (incluse)

CE



UNI EN 26789
ISO 6789

Nm	Kgfm	lbf.ft	■	D mm	A mm	L mm	kg
12÷60	1,2÷6	8÷44	3/8	30	33	413	0,8

599DGT/6 € 280,00 1 005990003

Nm	Kgfm	lbf.ft	■	D mm	A mm	L mm	kg
20÷100	2÷20	15÷80	1/2	30	37	413	1

599DGT/10X € 290,00 1 005990010

Nm	Kgfm	lbf.ft	■	D mm	A mm	L mm	kg
40÷200	4÷20	30÷150	1/2	40	43	520	2

599DGT/20 € 310,00 1 005990020

Nm	Kgfm	lbf.ft	■	D mm	A mm	L mm	kg
68÷340	6,8÷34	58÷280	1/2	40	43	539	2,35

599DGT/30 € 340,00 1 005990030

599DGT-A

chiave dinamometrica elettronica a lettura di coppia e angolo con cricchetto reversibile, per serraggi destrorsi (precisione +/- 2%) e sinistrorsi (precisione +/- 3%)

- Software interno per la memorizzazione dei dati: possibilità di preregolare fino a 9 valori di coppia/angolo
- Software e cavo USB per scaricare i dati
- Doppia modalità di misura: picco e traccia
- Il raggiungimento della coppia o dell'angolo prefissati vengono segnalati da avvisatori luminosi e da un suono intermittente
- Impugnatura bimatерiale antiscivolo
- Alimentazione: 2 batterie AA - 1,5V incluse

12"

CE



UNI EN 26789
ISO 6789

Nm	Kgfm	lbf.ft	■	D mm	A mm	L mm	kg
20÷100	2÷10	15÷80	1/2	30	33	413	1

599DGT-A/10 € 498,00 1 005990510

Nm	Kgfm	lbf.ft	■	D mm	A mm	L mm	kg
40÷200	4÷20	30÷150	1/2	40	43	520	2

599DGT-A/20 € 530,00 1 005990520

Servizio di taratura
dinamometria
a fine listino

600

attrezzi per serraggi angolari

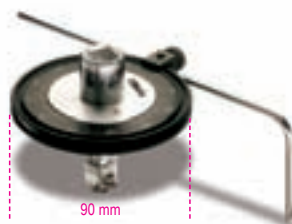

□	■	€	1	006000001
600/1	1/2	110,00	1	006000001
600/2	3/4	125,00	1	006000002

601

goniometro elettronico per serraggi angolari il raggiungimento dell'angolo prefissato viene segnalato da avvisatori luminosi e da un suono intermittente

CE

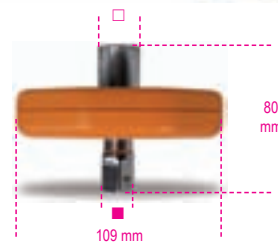

□	■	€	1	006010001
601 1/2	1/2"	185,00	1	006010001
601 3/4	3/4"	195,00	1	006010002

240x210x105 mm - 765 g

603

chiavi dinamometriche a slittamento per serraggi destrorsi precisione di serraggio ± 6%

1/4"



ISO 6789

Nm	Kgfm	lbf.in	■	A mm	L mm	g
1÷5	0,1÷0,5	10÷45	1/4	35	195	235

603/5 € 450,00 1 006030005

Nm	Kgfm	lbf.in	■	A mm	L mm	g
2÷10	0,2÷1,0	18÷90	1/4	35	195	235

603/10 € 460,00 1 006030010

604B

barre dinamometriche a disinnesto per serraggi destrorsi e sinistrorsi precisione di serraggio ± 6%



Nm	kgfm	lbf.in	Ø mm	L mm	g
1÷5	0,1÷0,5	10÷45	8	220	290

604B/5 € 269,00 1 006040015

Nm	Kgfm	lbf.in	Ø mm	L mm	g
2÷10	0,2÷1,0	18÷90	8	220	300

604B/10 € 269,00 1 006040020

Beta

ISO 9001

606/2 - 606/2X

chiavi dinamometriche a scatto con cricchetto reversibile per serraggi destrorsi precisione di serraggio $\pm 4\%$



UNI EN 26789
ISO 6789

Nm	Kgfm	lbf.in	■	D mm	A mm	L mm	g
4÷20	0,4÷2	40÷180	1/4	28	25	220	400

606/2	€ 207,00	1	006060102
-------	----------	---	-----------

Nm	Kgfm	lbf.in	■	D mm	A mm	L mm	g
4÷20	0,4÷2	40÷180	3/8	28	31	220	400

606/2X	€ 207,00	1	006060103
--------	----------	---	-----------

606/6 ÷ 606/30

chiavi dinamometriche a scatto con cricchetto reversibile per serraggi destrorsi precisione di serraggio $\pm 4\%$



UNI EN 26789
ISO 6789

Nm	Kgfm	lbf.ft	■	D mm	A mm	L mm	g
8÷60	0,8÷6	6÷44	3/8	30	33	305	595

606/6	€ 163,00	1	006060105
-------	----------	---	-----------

Nm	Kgfm	lbf.ft	■	D mm	A mm	L mm	g
20÷100	2÷10	15÷80	3/8	30	33	345	660

606/10	€ 165,00	1	006060110
--------	----------	---	-----------

Nm	Kgfm	lbf.ft	■	D mm	A mm	L mm	g
20÷100	2÷10	15÷80	1/2	30	37	345	680

606/10X	€ 170,00	1	006060111
---------	----------	---	-----------

Nm	Kgfm	lbf.ft	■	D mm	A mm	L mm	g
40÷200	4÷20	30÷150	1/2	40	43	440	920

606/20	€ 180,00	1	006060120
--------	----------	---	-----------

Nm	Kgfm	lbf.ft	■	D mm	A mm	L mm	g
60÷330	6÷33	40÷250	1/2	40	43	560	1180

606/30	€ 205,00	1	006060130
--------	----------	---	-----------

608/2

barra dinamometrica a scatto per serraggi destrorsi e sinistrorsi precisione di serraggio $\pm 4\%$



UNI EN 26789
ISO 6789

Nm	Kgfm	lbf.in	Ø mm	L mm	g
4÷20	0,4÷2	40÷180	16	208	330

608/2	€ 140,00	1	006080102
-------	----------	---	-----------

611

cricchetti reversibili per barre dinamometriche 604B/5 e 604B/10



■	L mm	€	1	006110001
1/4	42,5	95,00	1	006110001

Servizio di taratura dinamometria a fine listino

612 ÷ 614

cricchetti reversibili per barre dinamometriche



Gli articoli 612 e 612X non devono essere utilizzati con coppie di serraggio superiori a 100 Nm

	■	L mm	€	2	006120000
612	3/8	66	48,00	2	006120000
612X	1/2	66	52,00	2	006120010
614	1/2	71	57,00	2	006140000
614X	3/4	71	65,00	2	006140004

614/50

cricchetto semplice per barre dinamometriche



	■	L mm	€	2	006140002
614/50	1/2	71	49,00	2	006140002

Meccanismi rotanti di ricambio dei cricchetti, vedi tabella dopo l'art. 929/C8

616 - 617 - 619

quadri maschi per barre dinamometriche



	■	L mm	€	1	006160000
616	1/4	61	38,00	1	006160000
617	3/8	61	38,00	1	006170000
619	1/2	63	38,00	1	006190000

641

chiavi a forchetta per barre dinamometriche 604B/5 e 604B/10



Ø mm	L mm	€	1	006410003
4	37	56,00	1	006410003
5	37	56,00	1	006410004
5,5	37	56,00	1	006410005
6	37	56,00	1	006410006
7	37	56,00	1	006410007
8	42	56,00	1	006410008
9	42	56,00	1	006410009
10	42	56,00	1	006410010

642

chiavi a forchetta per barre dinamometriche



Ø mm	L mm	€	1	006420010
10	57	39,00	1	006420010
12	58	39,00	1	006420012
13	58	39,00	1	006420013
14	59	39,00	1	006420014
17	60	39,00	1	006420017
19	61	39,00	1	006420019
21	62	55,00	1	006420021
22	62	55,00	1	006420022
24	63	55,00	1	006420024
26	64	65,00	1	006420026
27	65	65,00	1	006420027
30	66	65,00	1	006420030
32	67	65,00	1	006420032

652

chiavi poligonali
per barre dinamometriche



mm	L mm	€		
10	59	42,00	1	006520010
13	61	42,00	1	006520013
14	62	42,00	1	006520014
17	64	42,00	1	006520017
19	65	42,00	1	006520019
21	66	60,00	1	006520021
22	66	60,00	1	006520022
24	67	72,00	1	006520024
26	68	72,00	1	006520026
27	69	72,00	1	006520027
30	70	72,00	1	006520030
32	71	72,00	1	006520032

666

chiavi dinamometriche a scatto
con cricchetto reversibile
per serraggi destrorsi
precisione di serraggio $\pm 4\%$



UNI EN 26789
ISO 6789

Nm	Kgfm	lbf.ft	■	D mm	A mm	L mm	g
8÷60	0,8÷6	6÷44	3/8	30	33	305	600

666/6 € 178,00 1 006660106

Nm	Kgfm	lbf.ft	■	D mm	A mm	L mm	g
20÷100	2÷10	15÷80	3/8	30	33	345	680

666/10 € 181,00 1 006660110

Nm	Kgfm	lbf.ft	■	D mm	A mm	L mm	g
20÷100	2÷10	15÷80	1/2	30	37	350	780

666/10X € 187,00 1 006660111

Nm	Kgfm	lbf.ft	■	D mm	A mm	L mm	g
40÷200	4÷20	30÷150	1/2	40	43	440	995

666/20 € 200,00 1 006660120

Nm	Kgfm	lbf.ft	■	D mm	A mm	L mm	g
60÷330	6÷33	40÷250	1/2	40	43	560	1260

666/30 € 227,00 1 006660130

667

chiavi dinamometriche a scatto
con cricchetto semplice
per serraggi destrorsi e sinistrorsi
precisione di serraggio $\pm 4\%$



UNI EN 26789
ISO 6789

Nm	Kgfm	lbf.ft	■	D mm	A mm	L mm	g
40÷200	4÷20	30÷150	1/2	40	43	440	960

667/20 € 187,00 1 006670120

Nm	Kgfm	lbf.ft	■	D mm	A mm	L mm	g
60÷330	6÷33	40÷250	1/2	40	43	560	1260

667/30 € 210,00 1 006670130

Nm	Kgfm	lbf.ft	■	D mm	A mm	L mm	g
80÷400	8÷40	60÷320	3/4	50	50	690	2200

667/40 € 450,00 1 006670140

**Meccanismi rotanti
di ricambio dei cricchetti,
vedi tabella dopo l'art. 929/C8**

668

barre dinamometriche a scatto
per serraggi destrorsi e sinistrorsi
precisione di serraggio $\pm 4\%$



UNI EN 26789
ISO 6789

Nm	Kgfm	lbf.ft	□	L mm	g
8÷60	0,8÷6	6÷44	16	300	530

668/5 € 151,00 1 006680105

Nm	Kgfm	lbf.ft	□	L mm	g
20÷100	2÷10	15÷80	16	340	610

668/10 € 159,00 1 006680110

Nm	Kgfm	lbf.ft	□	L mm	g
40÷200	4÷20	30÷150	16	420	780

668/20 € 173,00 1 006680120

Nm	Kgfm	lbf.ft	□	L mm	g
60÷300	6÷30	40÷220	16	550	1100

668/30 € 200,00 1 006680130

668RG

barra dinamometrica a scatto,
non graduata
adatta a serraggi destrorsi e sinistrorsi
precisione di serraggio $\pm 4\%$
(per il settaggio della coppia usare gli art.
680/40 - 682)



UNI EN 26789
ISO 6789

Nm	Kgfm	lbf.ft	□	L mm	g
8÷60	0,8÷6	6÷44	16	288	550

668RG/6 € 131,00 1 006680206

Nm	Kgfm	lbf.ft	□	L mm	g
10÷100	1÷10	8÷80	16	315	600

668RG/10 € 136,00 1 006680210

Nm	Kgfm	lbf.ft	□	L mm	g
20÷200	2÷20	15÷150	16	405	780

668RG/20 € 146,00 1 006680220

Nm	Kgfm	lbf.ft	□	L mm	g
30÷300	3÷30	22÷220	16	645	1130

668RG/30 € 166,00 1 006680230

669

barre dinamometriche a scatto,
attacco rettangolare
per serraggi destrorsi e sinistrorsi
precisione di serraggio $\pm 4\%$



UNI EN 26789
ISO 6789

Nm	Kgfm	lbf.ft	□	L mm	g
8÷60	0,8÷6	6÷44	9x12	300	530

669/6 € 165,00 1 006690005

Nm	Kgfm	lbf.ft	□	L mm	g
20÷100	2÷10	15÷80	9x12	340	610

669/10 € 175,00 1 006690010

Nm	Kgfm	lbf.ft	□	L mm	g
40÷200	4÷20	30÷150	9x12	420	780

669/20 € 215,00 1 006690020

Nm	Kgfm	lbf.ft	□	L mm	g
60÷300	6÷30	40÷220	14x18	550	1100

669/30 € 225,00 1 006690030



669RG

barra dinamometrica a scatto, attacco rettangolare non graduata adatta a serraggi destrorsi e sinistrorsi precisione di serraggio $\pm 4\%$ (per il settaggio della coppia usare gli artt. 680/40 - 682)



UNI EN 26789
ISO 6789

Nm	Kgfm	lbf.ft	□ mm	L mm	g
8÷60	0,8÷6	6÷44	9x12	288	550

669RG/6 € 159,00 1 006690106

Nm	Kgfm	lbf.ft	□ mm	L mm	g
10÷100	1÷10	8÷80	9x12	315	600

669RG/10 € 173,00 1 006690110

Nm	Kgfm	lbf.ft	□ mm	L mm	g
20÷200	2÷20	15÷150	14x18	405	780

669RG/20 € 203,00 1 006690120

Nm	Kgfm	lbf.ft	□ mm	L mm	g
30÷300	3÷30	22÷220	14x18	645	1130

669RG/30 € 215,00 1 006690130

671B/C5

barra dinamometrica 604B/5 e accessori

14" 



671B/C5 € 632,00 1 006710001

604B/5	5 Nm
611	1/4
641	5-6-7-8 mm
900	4-5-5,5-6-7-8-9-10 mm

270x120x45 mm - 1,1 kg

671B/C10

barra dinamometrica 604B/10 e accessori

14" 



671B/C10 € 632,00 1 006710002

604B/10	10 Nm
611	1/4
641	6-7-8-10 mm
900	4-5-5,5-6-7-8-9-10 mm

270x120x45 mm - 1,1 kg

671/C10

barra dinamometrica 668/10 e accessori

38" 



671/C10 € 752,00 1 006710010

668/10	100 Nm
612	3/8
617	3/8
642	10-13-14-17-19 mm
652	10-13-14-17-19 mm
910A	3/8-8-10-11-13-14-17-19 mm
910/21	125 mm
910/22	250 mm

400x180x45 mm - 4,3 kg

671/C20

barra dinamometrica 668/20 e accessori

12" 



671/C20 € 801,00 1 006710020

668/20	200 Nm
614	1/2
619	1/2
642	10-13-14-17-19 mm
652	10-13-14-17-19 mm
920A	1/2-10-11-13-14-17-19-22 mm
920/20	75 mm
920/21	125 mm
920/22	255 mm

510x180x45 mm - 5,5 kg

671/C30

barra dinamometrica 668/30 e accessori

12" 



671/C30 € 765,00 1 006710030

668/30	300 Nm
614	1/2
619	1/2
642	13-14-17-19 mm
652	13-14-17-19 mm
920A	1/2-13-14-17-19-22-24-27 mm
920/20	75 mm
920/21	125 mm
920/22	255 mm

620x180x45 mm - 5,8 kg

677

chiavi dinamometriche a disinnesto con cricchetto semplice per serraggi destrorsi e sinistrorsi precisione di serraggio $\pm 4\%$

34" 



UNI EN 26789
ISO 6789

Nm	Kgfm	lbf.ft	D mm	A mm	L mm	kg
100÷500	10÷50	70÷350	70	55	915	5,2

677/50 € 590,00 1 006770050

Nm	Kgfm	lbf.ft	D mm	A mm	L mm	kg
150÷700	15÷70	100÷500	70	55	1140	6,2

677/70 € 620,00 1 006770070

Nm	Kgfm	lbf.ft	D mm	A mm	L mm	kg
300÷1000	30÷100	200÷750	70	55	1470	7,5

677/100 € 650,00 1 006770100

677/C...

chiavi dinamometriche 677 in cassetta

34" 



677/C50 € 705,00 1 006770605
Nm 100÷500

677/C70 € 776,00 1 006770610
Nm 150÷700

677/C100 € 836,00 1 006770615
Nm 300÷1000

678

chiavi dinamometriche a scatto con cricchetto semplice per serraggi destrorsi e sinistrorsi precisione di serraggio $\pm 4\%$

3/4"

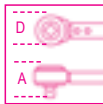

UNI EN 26789
ISO 6789

Nm	Kgfm	lbf.ft	D mm	A mm	L mm	kg
110÷550	11÷55	80÷405	61	55	845	3,7

678/55 € 1.090,00 1 006780055

Nm	Kgfm	lbf.ft	D mm	A mm	L mm	kg
300÷1000	30÷100	220÷750	75	60	1250	6,0

678/100 € 1.490,00 1 006780100

Nm	Kgfm	lbf.ft	D mm	A mm	L mm	kg
500÷1500	50÷150	370÷1100	75	60	1570	6,7

678/150 € 1.560,00 1 006780150

Servizio di taratura
dinamometria
a fine listino

678/C...

chiavi dinamometriche 678
in cassetta

3/4"



678/C55 € 1.205,00 1 006780605

678/C100 € 1.645,00 1 006780610

678/C150 € 1.745,00 1 006780615

678/CV...

cassette vuote
per chiavi dinamometriche 677 e 678



678/CV1 € 115,00 1 006780405

678/CV2 € 156,00 1 006780410

678/CV3 € 186,00 1 006780415

680/40

misuratore di coppia elettronico digitale
Dynatester 680
per verifica tarature
funzionamento destrorso e sinistrorso

12"

CE



680/40 Nm kg 4 € 1.650,00 1 006800040

682

misuratore di coppia elettronico digitale
con trasduttori porziometrici
Dynatester 682
funzionamento destrorso e sinistrorso

Alta precisione di lettura
Fornito di uscita seriale RS 232



CE

CARATTERISTICHE TECNICHE:

Precisione di lettura: $\pm 1\%$ del valore letto
Unità di misura selezionabili
Nm-dNm-cNm-Lbf.ft-Lbf.in-Ozf.in-Kgf.m-Kgf.cm-gf.cm
Alimentazione: 90 a 264V AC a 50/60 Hz
Dimensioni: 235x185x185 mm
Verifica di tolleranza secondo norma ISO6789
Indicazione dell'intervallo di accettabilità specifico per ogni chiave dinamometrica testata
Display: Menu selezionabile in 11 lingue
Documentazione allegata
Certificato di calibrazione con rintracciabilità UKAS

	Nm	kg	€		
682/60	1,2÷60	5,9	4.100,00	1	006820006
682/400	8÷400	6,1	4.150,00	1	006820040
682/1500	30÷1500	6,4	4.300,00	1	006820150

710

chiavi a bussola Macchina
serie normale

3/8"



UNI/ISO 2725 DIN 3129

Ø mm	Ø mm	L mm	Ø1 mm	€		
7	12,5	28	19	8,50	5	007100007
8	13,8	28	19	8,50	5	007100008
9	15,0	28	19	8,50	5	007100009
10	16,3	28	19	8,50	5	007100010
11	17,5	30	19	8,50	5	007100011
12	19,0	30	19	8,50	5	007100012
13	20,0	30	22	9,00	5	007100013
14	21,3	30	22	9,00	5	007100014
16	23,8	30	22	9,00	5	007100016
17	25,0	30	22	9,00	5	007100017
18	26,3	30	22	9,40	5	007100018
19	27,5	30	22	9,40	5	007100019
21	30,0	32	22	10,20	5	007100021
22	32,0	32	22	11,30	5	007100022

710/16

raccordo Macchina con attacco quadro
femmina 3/8" e maschio 1/2"

3/8"



L mm	Ø mm	3/8"	1/2"	€		
32	22	3/8"	1/2"	17,00	3	007100810

710/20

prolunga Macchina con attacchi quadri
maschio e femmina 3/8"

3/8"



L mm	Ø mm	€		
75	22	17,00	3	007100821

710/21

prolunga Macchina con attacchi quadri
maschio e femmina 3/8"

3/8"



L mm	Ø mm	€		
125	22	19,00	3	007100823

710/25

snodo Macchina con attacchi quadri
maschio e femmina 3/8"

3/8"



L mm	Ø mm	€		
58	24	36,50	2	007100830

710/C10

10 chiavi a bussola Macchina



710/C10 € 101,00 1 007100910
7-8-10-11-12-13
14-17-19-22 mm

130x55x40 mm - 800 g

710/OR... - 710/SP...

anelli e spine per bussole e accessori Macchina

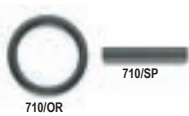

	710 mm	710/16 L mm	€		
710/OR1	7÷12		0,50	10	007100921
710/OR2	13÷22	32	0,50	10	007100922
710/SP1	7÷12		1,00	10	007100911
710/SP2	13÷22	32	1,00	10	007100912

720

chiavi a bussola Macchina serie normale



UNI/ISO 2725 DIN 3129

mm	Ø mm	L mm	Ø1 mm	€		
10	17,0	38	25	10,10	5	007200010
11	18,5	38	25	10,10	5	007200011
12	20,0	38	25	10,10	5	007200012
13	21,0	38	25	10,10	5	007200013
14	22,5	38	25	10,10	5	007200014
15	23,0	38	30	11,00	5	007200015
16	25,0	38	30	11,00	5	007200016
17	26,0	38	30	11,00	5	007200017
18	27,5	38	30	11,00	5	007200018
19	28,5	38	30	11,00	5	007200019
21	31,0	38	30	12,30	5	007200021
22	32,5	38	30	12,30	5	007200022
23	34,0	38	30	13,10	5	007200023
24	35,0	38	30	13,10	5	007200024
27	38,5	45	30	15,40	3	007200027
30	42,0	50	30	17,10	3	007200030
32	44,0	50	30	19,00	3	007200032
36	50,0	50	30	28,50	3	007200036

720AS

chiavi a bussola Macchina serie normale



mm	Ø mm	L mm	Ø1 mm	€		
3/8	17,0	38	25	13,00	3	007200210
7/16	18,2	38	25	13,00	3	007200211
1/2	20,7	38	25	13,00	3	007200213
9/16	22,0	38	25	13,00	3	007200214
5/8	24,5	38	30	14,00	3	007200216
11/16	25,7	38	30	14,00	3	007200217
3/4	28,2	38	30	14,00	3	007200219
13/16	30,7	38	30	15,00	3	007200221
7/8	32,0	38	30	15,00	3	007200222
15/16	34,5	38	30	16,00	3	007200224
1	35,7	38	30	17,00	3	007200225
1.1/16	38,2	40	30	18,50	3	007200227
1.1/8	40,7	42	30	20,50	3	007200229
1.1/4	44,5	42	30	22,50	3	007200232

720L

chiavi a bussola Macchina serie lunga



UNI/ISO 2725

mm	Ø mm	L mm	Ø1 mm	€		
10	17,0	80	25	17,10	2	007200310
11	18,5	80	25	17,10	2	007200311
12	20,0	80	25	17,10	2	007200312
13	21,0	80	25	17,10	2	007200313
14	22,5	80	25	17,10	2	007200314
15	23,0	80	30	19,10	2	007200315
16	25,0	80	30	19,10	2	007200316
17	26,0	80	30	19,10	2	007200317
18	27,5	80	30	20,60	2	007200318
19	28,5	80	30	20,60	2	007200319
21	31,0	80	30	21,80	2	007200321
22	32,5	80	30	21,80	2	007200322
24	35,0	80	30	22,30	2	007200324
27	38,5	80	30	27,50	2	007200327
30	42,0	80	30	35,00	2	007200330
32	44,0	80	30	35,00	2	007200332
36	50,0	80	30	54,00	2	007200336

720L/S3

serie di 3 chiavi a bussola 720L



17-19-21 € 61,50 1 007200355

720LS

chiavi a bussola Macchina serie lunga sottile



UNI/ISO 2725

mm	Ø mm	L mm	Ø1 mm	€		
10	15,5	78	24	18,50	2	007200360
11	16,7	78	24	18,50	2	007200361
12	18,0	78	24	18,50	2	007200362
13	19,2	78	24	18,50	2	007200363
14	20,5	78	24	18,50	2	007200364
15	21,7	78	24	21,00	2	007200365
16	23,0	78	24	21,00	2	007200366
17	24,2	78	29	21,00	2	007200367
18	25,5	78	29	22,50	2	007200368
19	26,7	78	29	22,50	2	007200369
21	29,2	78	29	24,00	2	007200371
22	30,5	78	29	24,00	2	007200372
24	33,0	78	29	24,50	2	007200374
27	36,7	78	29	30,00	2	007200377
30	40,5	78	29	38,00	2	007200380
32	43,0	78	29	38,00	2	007200382
36	48,0	78	29	59,00	2	007200386

720PL

chiavi a bussola Macchina con inserti polimerici per dadi ruote



mm	Ø mm	€		
17	29,5	16,60	2	007200617
19	29,5	16,60	2	007200619
21	31,0	17,30	2	007200621
22	33,0	18,50	2	007200622
24	35,0	20,80	2	007200624

720PL/C5

5 chiavi a bussola Macchina con inserti polimerici per dadi ruote



720PL/C5 € 94,50 1 007200650
17-19-21-22-24 mm

240x165x50 mm - 1,8 kg

720LPL

chiavi a bussola Macchina con inserti polimerici per dadi ruote serie lunga



mm	Ø mm	€		
17	24,3	25,00	1	007200717
19	26,2	25,00	1	007200719
21	28,5	25,00	1	007200721



720LPL/C3

3 chiavi a bussola Macchina lunghe con inserti polimerici per dadi ruote

fornito con 3 inserti di ricambio



720LPL/C3 € 93,50 1 007200750
17-19-21 mm

270x185x60 mm - 1 kg

720IP

inserti di ricambio polimerici per chiavi a bussola 720PL-LPL



	mm	€		
720IP17	17	2,10	1	007200667
720IP19	19	2,10	1	007200669
720IP21	21	2,10	1	007200671
720IP22	22	2,10	1	007200672
720IP24	24	2,10	1	007200674

720FTX

chiavi a bussola Macchina per viti con testa a profilo Torx®



	Ø mm	L mm	Ø1 mm	€		
E10	14,0	38	25	13,60	3	007200410
E12	15,9	38	25	13,60	3	007200412
E14	17,7	38	25	13,60	3	007200414
E16	20,0	38	25	13,60	3	007200416
E18	22,0	38	25	13,60	3	007200418
E20	25,0	40	25	15,40	3	007200420



720FTX/SB6 € 90,00 1 007200450
E10-E12-E14
E16-E18-E20

720TX

chiavi a bussola maschio Macchina per viti con impronta Torx®



	Ø mm	L mm	L1 mm	€		
T30	25	60	40	13,80	3	007200460
T40	25	60	40	13,80	3	007200470
T45	25	68	48	14,20	3	007200472
T50	25	68	48	14,20	3	007200474
T55	25	68	48	15,60	3	007200476
T60	25	68	48	17,00	3	007200478

720TX/C6

6 chiavi a bussola maschio Macchina per viti con impronta Torx®



720TX/C6 € 110,50 1 007200483
T30-T40-T45
T50-T55-T60

275x120x65 mm - 5700 g

720ME

chiavi a bussola Macchina maschio esagonale



mm	Ø mm	L mm	L1 mm	€		
5	25	60	40	11,00	3	007200505
6	25	60	40	11,00	3	007200506
8	25	60	40	11,00	3	007200508
10	25	68	48	11,00	3	007200510
12	25	68	48	11,00	3	007200512
14	25	78	58	12,60	3	007200514
17	25	78	58	12,60	3	007200517
19	25	78	58	12,60	3	007200519

720ME/C8

8 chiavi a bussola Macchina maschio esagonale



720ME/C8 € 112,00 1 007200525
5-6-8-10-12
14-17-19 mm

270x120x45 mm - 1710 g

720/15

raccordo Macchina con attacco quadro femmina 1/2" e maschio 3/8"



L mm Ø mm □ ■ € 15,00 3 007200810
37,5 25 1/2 3/8



E' assolutamente necessario commisurare la coppia di serraggio alla capacità del quadro maschio per evitare rotture o danni accidentali

720/16

raccordo Macchina con attacco quadro femmina 1/2" e maschio 3/4"



L mm Ø mm □ ■ € 19,00 3 007200814
44 30 1/2 3/4

720/20

prolunga Macchina con attacchi quadri maschio e femmina 1/2"



L mm Ø mm € 19,50 3 007200818
75 30

720/21

prolunga Macchina con attacchi quadri maschio e femmina 1/2"



L mm Ø mm € 21,00 3 007200822
125 30

720/25

snodo Macchina con attacchi quadri maschio e femmina 1/2"



L mm Ø mm € 41,00 2 007200830
72 30

720/C6

6 chiavi a bussola Macchina

12"



720/C6 € 83,00 1 007200910

13-14-17-19-22-24 mm

195x80x55 mm - 1100 g

720/C12

12 chiavi a bussola Macchina

12"



720/C12 € 165,00 1 007200912

10-11-12-13-14-17
19-22-24-27-30-32 mm

195x80x55 mm - 2000 g

720T

barre di torsione Macchina per dadi ruote autoveicoli con attacchi quadri maschio e femmina 1/2"

12"



Nm	L mm	€		
90	200	16,00	1	007200760
100	200	16,00	1	007200762
110	200	16,00	1	007200764
120	200	16,00	1	007200766



720T/B4 € 70,00 1 007200780

720/OR... - 720/SP...

anelli e spine per bussole e accessori Macchina

12"



	720 mm	720TX	€		
720/OR1	10÷14	T30÷T60	1,00	10	007200923
720/OR2	15÷32		1,00	10	007200924
720/SP1	10÷14	T30÷T60	1,50	10	007200913
720/SP2	15÷32		1,50	10	007200914

727PI/16

bussola portainseri Macchina per 727/ES16 e 727/ES16TX

3/4"



Ø mm	L mm	Ø mm		€	
44	52	16	3/4	33,00	2 007270016

727/ES16

inserti Macchina maschio esagonale, attacco 16 mm

3/4"



mm	Ø mm	L mm	€		
10	16	40	11,00	2	007270110
12	16	40	11,00	2	007270112
13	16	40	11,00	2	007270113
14	16	40	11,00	2	007270114
16	16	40	12,00	2	007270116
17	16	40	12,00	2	007270117
18	16	40	12,50	2	007270118
19	16	40	12,50	2	007270119
22	16	40	14,50	2	007270122

727/ES16TX

inserti Macchina maschio per viti con impronta Torx®, attacco 16 mm

3/4"



mm	Ø mm	L mm	€		
T55	16	50	17,00	2	007270355
T60	16	50	17,00	2	007270360
T70	16	50	17,00	2	007270370

727PI/22

bussola portainseri Macchina per 727/ES22 e 727/ES22TX

1"



Ø mm	L mm	Ø mm	€		
54	70	22	53,00	2	007270022

Beta

727/ES22

inserti Macchina maschio esagonale, attacco 22 mm

1"



mm	Ø mm	L mm	€		
19	22	50	14,50	2	007270219
22	22	50	14,50	2	007270222
24	22	50	16,00	2	007270224
27	22	50	18,00	2	007270227
30	22	50	21,50	2	007270230
32	22	50	23,00	2	007270232

727/ES22TX

inserti Macchina maschio per viti con impronta Torx®, attacco 22 mm

1"



	Ø mm	L mm	€		
T80	22	60	24,00	2	007270480
T90	22	60	24,00	2	007270490
T100	22	60	24,00	2	007270500

727/C16

12 inserti Macchina maschio e 4 accessori

1"



1"

727/C16 € 320,00 1 007270900

727PI/16
727/ES16 14-17-19 mm
727/ES16TX T55-T60-T70
727PI/22
727/ES22 22-24-27 mm
727/ES22TX T80-T90-T100
96BPC 3-4 mm

335x145x60 mm - 3,6 kg

727PI/32

bussola portainseri Macchina per 727/ES32



Ø mm	L mm	Ø mm	€		
86	66	32	125,00	1	007270032

727/ES32

inserti Macchina maschio esagonale, attacco 32 mm



mm	Ø mm	L mm	€		
19	32	44	33,00	2	007270519
22	32	44	33,00	2	007270522
24	32	44	33,00	2	007270524
27	32	44	33,00	2	007270527
30	32	44	33,00	2	007270530
32	32	44	33,00	2	007270532
36	32	44	33,00	2	007270536

728

chiavi a bussola Macchina serie normale



UNI/ISO 2725 DIN 3129

Ø mm	Ø mm	L mm	Ø1 mm	€	
17	30,0	51	44	24,00	2 007280017
18	31,0	51	44	24,00	2 007280018
19	32,5	51	44	24,00	2 007280019
21	35,0	51	44	24,00	2 007280021
22	36,0	51	44	24,00	2 007280022
23	37,5	51	44	24,50	2 007280023
24	38,5	51	44	24,50	2 007280024
27	42,5	53	44	24,50	2 007280027
28	44,0	53	44	25,50	2 007280028
30	46,0	53	44	25,50	2 007280030
32	48,5	57	44	26,50	2 007280032
33	50,0	57	44	29,00	2 007280033
34	51,0	57	44	29,00	2 007280034
35	52,5	57	44	29,50	2 007280035
36	53,5	57	44	30,50	2 007280036
38	56,0	57	44	34,00	1 007280038
40	58,5	58	44	35,50	1 007280040
41	60,0	58	44	35,50	1 007280041
44	64,0	62	44	40,00	1 007280044
45	65,0	62	44	42,00	1 007280045
46	66,0	62	44	42,00	1 007280046
50	71,0	68	54	52,00	1 007280050
55	77,5	71	54	56,00	1 007280055
60	83,0	73	54	64,00	1 007280060

728FTX

chiavi a bussola Macchina per viti con testa a profilo Torx®



Ø mm	L mm	Ø1 mm	€		
E20	28,5	50	44	30,00	2 007280420
E22	30,0	50	44	30,00	2 007280422
E24	32,5	50	44	30,00	2 007280424

728L

chiavi a bussola Macchina serie lunga



Ø mm	Ø mm	L mm	Ø1 mm	€	
19	32,5	90	44	38,00	2 007280319
21	35,0	90	44	38,00	2 007280321
22	36,0	90	44	38,00	2 007280322
24	38,5	90	44	38,00	2 007280324
26	41,0	90	44	38,00	2 007280326
27	42,5	90	44	38,00	2 007280327
30	46,0	90	44	40,00	2 007280330
32	48,5	90	44	42,00	2 007280332
33	50,0	90	44	44,00	1 007280333
34	51,0	90	44	47,00	1 007280334
36	53,5	90	44	50,00	1 007280336
38	56,0	90	44	50,00	1 007280338
41	60,0	90	44	58,00	1 007280341
46	66,0	90	44	67,00	1 007280346
50	71,0	90	44	80,00	1 007280350
55	77,5	100	54	105,00	1 007280355

728LS

chiavi a bussola Macchina serie lunga sottile



Ø mm	Ø mm	L mm	Ø1 mm	€	
17	28,0	100	43	41,00	2 007280517
19	30,5	100	43	41,00	2 007280519
22	34,3	100	43	41,00	2 007280522
24	36,8	100	43	41,00	2 007280524
27	40,5	100	43	41,00	2 007280527
30	44,3	100	43	41,00	2 007280530
32	46,8	100	43	46,00	2 007280532
33	48,0	100	43	46,00	2 007280533
36	51,8	100	43	53,00	2 007280536

728LS/S3

serie di 3 chiavi a bussola 728LS



mm	€		
22-24-27	123,00	1	007280550

728LQ

chiavi a bussola Macchina serie lunga (per dadi ruote ISUZU)



Ø mm	L mm	Ø mm	Ø1 mm	€	
19	90	35	43,5	28,00	1 007280619
21	90	42	43,5	28,00	1 007280621

728/15

raccordo Macchina con attacco quadro femmina 3/4" e maschio 1/2"



L mm	Ø mm	□	■	€	
54	44	3/4	1/2	30,00	2 007280810

E' assolutamente necessario commisurare la coppia di serraggio alla capacità del quadro maschio per evitare rotture o danni accidentali

728/16

raccordo Macchina con attacco quadro femmina 3/4" e maschio 1"



L mm	Ø mm	□	■	€	
62	44	3/4	1	36,00	2 007280813

728/21

prolunga Macchina con attacchi quadri maschio e femmina 3/4"



L mm	Ø mm	€	
175	44	39,00	2 007280815

728/22

prolunga Macchina con attacchi quadri maschio e femmina 3/4"



L mm	Ø mm	€	
250	44	46,00	2 007280825

728/22L

prolunga Macchina con attacchi quadri maschio e femmina 3/4"



L mm	Ø mm	€	
330	44	56,00	1 007280826

728/25

snodo Macchina con attacchi quadri maschio e femmina 3/4"



L mm	Ø mm	€	
107,5	44	79,00	1 007280830

728/C10

10 chiavi a bussola Macchina

3/4"



728/C10
17-19-22-24-27-30
32-36-41-46 mm

€ 304,00 1 007280910

275x120x65 mm - 5,7 kg

728/OR - 728/SP

anelli e spine per bussole e accessori Macchina

3/4"



728 728FTX
728/OR 17÷46 E20÷E24 € 1,00 10 007280926
728/SP 17÷46 E20÷E24 € 1,50 10 007280916

729

chiavi a bussola Macchina serie normale

1"



UNI/ISO 2725 DIN 3129

Ø mm	Ø mm	L mm	Ø1 mm	€	
24	41,5	58	54	38,00	1 007290024
27	45,0	60	54	38,00	1 007290027
30	49,0	62	54	38,00	1 007290030
32	51,5	63	54	39,00	1 007290032
33	52,5	63	54	39,00	1 007290033
34	54,0	63	54	39,00	1 007290034
36	56,5	66	54	39,00	1 007290036
38	59,0	66	54	47,00	1 007290038
41	62,5	68	54	48,00	1 007290041
46	69,0	72	54	50,00	1 007290046
50	74,0	76	54	65,00	1 007290050
55	80,0	84	54	69,00	1 007290055
60	86,5	88	54	84,00	1 007290060
65	92,5	92	54	97,00	1 007290065
70	99,0	96	54	103,00	1 007290070
75	105,0	102	63	136,00	1 007290075
80	111,5	102	63	139,00	1 007290080

729L

chiavi a bussola Macchina serie lunga

1"



Ø mm	Ø mm	L mm	Ø1 mm	€	
24	41,5	108	54	62,00	1 007290324
27	45,0	108	54	62,00	1 007290327
30	49,0	108	54	62,00	1 007290330
32	51,5	108	54	62,00	1 007290332
33	52,2	108	54	62,00	1 007290333
34	54,0	108	54	62,00	1 007290334

Ø mm	Ø mm	L mm	Ø1 mm	€	
36	56,5	108	54	62,00	1 007290336
41	62,5	108	54	79,00	1 007290341
46	69,0	108	54	91,00	1 007290346
50	74,0	108	54	102,00	1 007290350
55	80,0	108	54	120,00	1 007290355
60	86,5	108	54	133,00	1 007290360
65	92,5	108	54	159,00	1 007290365
70	99,0	108	54	177,00	1 007290370
75	105,0	108	63	199,00	1 007290375
80	111,5	108	63	209,00	1 007290380

729LS

chiavi a bussola Macchina serie lunga sottile

1"



Ø mm	Ø mm	L mm	Ø1 mm	€	
22	36,0	108	53	65,00	1 007290522
24	38,5	108	53	65,00	1 007290524
27	42,3	108	53	65,00	1 007290527
30	46,0	108	53	67,00	1 007290530
32	48,5	108	53	67,00	1 007290532
33	49,8	108	53	67,00	1 007290533
36	53,5	108	53	67,00	1 007290536

729T

barre di torsione Macchina per dadi ruote

1"



Ø mm	Nm	L mm	€	
24	350	300	97,00	1 007290724
27	450	300	97,00	1 007290757
30	500	300	97,00	1 007290730
32	450	300	97,00	1 007290732
32	600	300	97,00	1 007290762
33	600	300	108,00	1 007290763
36	600	300	108,00	1 007290736

729/15

raccordo Macchina con attacco quadro femmina 1" e maschio 3/4"

1"



L mm	Ø mm	€	
66,5	54	43,00	1 007290810

! E' assolutamente necessario commisurare la coppia di serraggio alla capacità del quadro maschio per evitare rotture o danni accidentali

729/16

raccordo Macchina con attacco quadro femmina 1" e maschio 1.1/2"

1"



L mm	Ø mm	€	
88	54,0	62,00	1 007290813

729/21

prolunga Macchina con attacchi quadri maschio e femmina 1"

1"



L mm	Ø mm	€	
175	54	64,00	1 007290815

729/22

prolunga Macchina con attacchi quadri maschio e femmina 1"

1"



L mm	Ø mm	€	
330	54	87,00	1 007290825

729/25

snodo Macchina con attacchi quadri maschio e femmina 1"

1"



L mm	Ø mm	€	
130	54	139,00	1 007290830

729/OR... - 729/SP...

anelli e spine per bussole e accessori Macchina

3/4"



1"

1 1/2"

728 mm	729-730 mm	€	
729/OR1 50÷60	24÷70	1,50	5 007290927
729/OR2	75÷125	2,00	5 007290928
729/SP1 50÷60	24÷70	1,50	5 007290917
729/SP2	75÷125	2,00	5 007290918

Beta

730

chiavi a bussola Macchina serie normale



UNI/ISO 2725 DIN 3129

Ø mm	L mm	Ø1 mm	€	Icona	Articolo
50	81	87	145,00	1	007300050
55	88	90	155,00	1	007300055
60	94	95	175,00	1	007300060
65	100	100	205,00	1	007300065
70	106	105	244,00	1	007300070
75	113	110	287,00	1	007300075
80	119	115	323,00	1	007300080
85	125	120	365,00	1	007300085
90	132	125	415,00	1	007300090
95	138	125	496,00	1	007300095
100	144	130	557,00	1	007300100
105	150	135	630,00	1	007300105
110	157	140	686,00	1	007300110
115	163	140	745,00	1	007300115
120	169	145	813,00	1	007300120
125	175	145	864,00	1	007300125

730/15

raccordo Macchina riduttore



L mm	Ø mm	Ø1 mm	€	Icona	Articolo
105	84,0	1.1/2	120,00	1	007300810



E' assolutamente necessario commisurare la coppia di serraggio alla capacità del quadro maschio per evitare rotture o danni accidentali

733/15

raccordo Macchina riduttore



L mm	Ø mm	Ø1 mm	€	Icona	Articolo
156	127	2.1/2	481,00	1	007330810

851

portainseri magnetico con impugnatura



L1 mm	L mm	€	Icona	Articolo
45	165	10,50	2	008510165
125	245	13,00	2	008510245

851SR

portainseri a sgancio rapido con impugnatura



L mm	L1 mm	€	Icona	Articolo
230	110	14,50	2	008510001

855P

Giravite portainseri a cricchetto reversibile con impugnatura snodata 7 inserti integrati

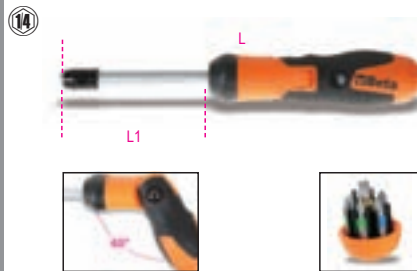

L mm	L1 mm	€	Icona	Articolo
240	100	49,00	1	008550010

- 860PH PH1 - PH2
- 860PZ PZ1 - PZ2
- 860LP LP 0,8x5,5 mm
- 860PE 4 - 5 mm

855T

portainseri con impugnatura a T, con sgancio rapido universale e cricchetto reversibile sul lato lungo



L mm	L1 mm	€	Icona	Articolo
185	135	37,00	1	008550050

860LP

inserti colorati per avvitatori per viti a testa con intaglio



ISO 2351-1
ISO 1173 C 6,3

SxA mm	L mm	€	Icona	Articolo
0,5x3	25	1,50	5	008600005
0,6x4,5	25	1,50	5	008600010
0,8x5,5	25	1,50	5	008600015
1x5,5	25	1,50	5	008600020
1,2x6,5	25	1,50	5	008600025

860PH

inserti colorati per avvitatori per viti con impronta a croce Phillips®



ISO 2351-2
ISO 1173 C 6,3

PH	L mm	€	Icona	Articolo
0	25	1,50	5	008600220
1	25	1,50	5	008600225
2	25	1,50	5	008600230
3	25	1,50	5	008600245
4	25	2,20	5	008600250

860PZ

inserti colorati per avvitatori per viti con impronta a croce Pozidriv® - Supadriv®



ISO 2351-2
ISO 1173 C 6,3

PZ	L mm	€	Icona	Articolo
1	25	1,50	5	008600320
2	25	1,50	5	008600325
3	25	1,50	5	008600330
4	25	2,20	5	008600335

860PE

inserti colorati maschio esagonale per avvitatori



ISO 2351-3
ISO 1173 C 6,3

mm	L mm	€	Icona	Articolo
2	25	1,60	5	008600101
2,5	25	1,60	5	008600102
3	25	1,60	5	008600103
4	25	1,60	5	008600104
5	25	1,60	5	008600105
6	25	1,60	5	008600106
8	25	2,00	5	008600108
10	25	2,00	5	008600110

860TX

inserti colorati per avvitatori per viti con impronta Torx®



ISO 1173 C 6,3

T	L mm	€	Icona	Articolo
T6	25	2,00	5	008600704
T7	25	2,00	5	008600705
T8	25	2,00	5	008600710
T9	25	2,00	5	008600715
T10	25	1,60	5	008600720
T15	25	1,60	5	008600725
T20	25	1,60	5	008600730
T25	25	1,60	5	008600735
T27	25	1,60	5	008600740
T30	25	1,60	5	008600745
T40	25	1,60	5	008600750

860RTX

inserti colorati per avvitatori per viti con impronta Tamper Resistant Torx®



ISO 1173 C 6,3

⊕	L mm	€	📦	📄
T9	25	2,20	5	008600550
T10	25	2,20	5	008600555
T15	25	2,20	5	008600560
T20	25	2,20	5	008600565
T25	25	2,20	5	008600570
T27	25	2,20	5	008600575
T30	25	2,20	5	008600580
T40	25	2,20	5	008600585

860/55

cricchetto reversibile portainseri



L mm	⊖	€	📦	📄
100	1/4	20,00	3	008600870

860/C27

25 inserti per avvitatori, 1 raccordo e 1 cricchetto reversibile in astuccio tascabile



860/C27	€	📦	📄
	64,00	1	008600880

	860/55	100 mm
	860LP	0,5x3-1,0x5,5-1,2x6,5 mm
	860PH	PH1-PH2(x2)-PH3
	860PZ	PZ1-PZ2(x2)-PZ3
	860PE	2-2,5-3-4-5-6 mm
	860TX	T6-T8-T10-T15-T20-T25-T30-T40
	892/0	● 1/4 ■ 1/4



860PHZ/A10

10 inserti con portainseri magnetico in astuccio tascabile



860PHZ/A10	€	📦	📄
	28,50	1	008600910

	860PH	PH1	1	n.
		PH2	3	
		PH3	1	
	860PZ	PZ1	1	
		PZ2	3	
		PZ3	1	
	882M1	○ 1/4 ● 1/4	1	

860PHZ/A31

30 inserti con portainseri magnetico a sgancio rapido in astuccio tascabile



860PHZ/A31	€	📦	📄
	59,00	1	008600912

	860PH	PH1	3	n.
		PH2	9	
		PH3	3	
	860PZ	PZ1	3	
		PZ2	9	
		PZ3	3	
	882MSR/50	○ 1/4 ● 1/4	1	

860PE/A10

10 inserti con portainseri magnetico in astuccio tascabile



860PE/A10	€	📦	📄
	30,00	1	008600920

	860PE	2-2,5 mm	1	n.
	882M1	3-4-5-6 mm	2	
		○ 1/4 ● 1/4		

860TX/A10

10 inserti con portainseri magnetico in astuccio tascabile



860TX/A10	€	📦	📄
	31,00	1	008600970

	860TX	T7 - T8 - T9 - T10 - T15 - T20	1	n.
		T25 - T27 - T30 - T40	1	
	882M1	○ 1/4 ● 1/4		

860TX/A31

30 inserti con portainseri magnetico a sgancio rapido in astuccio tascabile



860TX/A31	€	📦	📄
	65,50	1	008600972

	860TX	T6 - T7 - T8	2	n.
		T9 - T10 - T15 - T20 - T25	3	
		T27 - T30 - T40		
	882MSR/50	○ 1/4 ● 1/4		

860PHT/A31

30 inserti con portainseri magnetico a sgancio rapido in astuccio tascabile



860PHT/A31 € 61,00 1 008600940

Icona	Modello	Descrizione	n.
+	860PH	PH1	3
+	860PH	PH2	6
+	860TX	T10 - T15 - T20 - T25 - T27 - T30 - T40	3
+	882MSR/50	○ 1/4 ● 1/4	

860RTX/A10

10 inserti con portainseri magnetico in astuccio tascabile



860RTX/A10 € 35,50 1 008600930

Icona	Modello	Descrizione	n.
+	860RTX	T9-T10-T15-T20-T25-T27 T30-T40	1
+	882M1	○ 1/4 ● 1/4	2

860MIX/A10

10 inserti con portainseri magnetico in astuccio tascabile



860MIX/A10 € 28,50 1 008600900

Icona	Modello	Descrizione	n.
+	860LP	0,5x3 - 1x5,5 - 1,2x6,5 mm	1
+	860PH	PH1	1
+	860PH	PH2	2
+	860PZ	PH3	1
+	860PZ	PZ1 - PZ2 - PZ3	1
+	882M1	○ 1/4 ● 1/4	

860MIX/A31

30 inserti con portainseri magnetico a sgancio rapido in astuccio tascabile



860MIX/A31 € 63,00 1 008600902

Icona	Modello	Descrizione
+	860LP	0,5x3 - 0,6x4 - 0,8x5,5 - 1,0x5,5 - 1,2x6,5 mm
+	860PE	2 - 2,5 - 3 - 4 - 5 - 6 - 8 - 10 mm
+	860PH	PH0 - PH1 - PH2 - PH3 - PH4
+	860PZ	PZ1 - PZ2 - PZ3 - PZ4
+	860RTX	T9 - T10 - T15 - T20 - T25 - T27 - T30 - T40
+	882MSR/50	○ 1/4 ● 1/4

860/C38P

1 portainseri con impugnatura a criccheto reversibile, 27 inserti per avvitatori, 8 bussole esagonali e 2 accessori



860/C38P € 136,00 1 008600878

Icona	Modello	Descrizione
+	860LP	0,6x4,5 - 0,8x5,5 - 1,0x5,5 - 1,2x6,5 mm
+	860PE	2-2,5-3-4(x2)-5(x2)
+	860PH	PH1(x2)-PH2(x2)-PH3
+	860PZ	PZ1(x2)-PZ2(x2)-PZ3
+	860TX	T10-T15-T20-T25-T30-T40
+	900	5-5,5-6-7-8-9-10-13 mm
+	892/0	● 1/4 ■ 1/4
+	892/3	● 1/4 ■ 1/4
+	855P	240 mm

270x120x45 mm

861LP

inserti per avvitatori per viti a testa con intaglio



ISO 2351-1

ISO 1173 C 6,3

SxA mm	L mm	€	Icona	Icona	Descrizione
0,5x3	25	0,93	+	+	10 008610005
0,6x4,5	25	0,93	+	+	10 008610010
0,8x5,5	25	0,93	+	+	10 008610015
1x5,5	25	0,93	+	+	10 008610020
1,2x6,5	25	0,93	+	+	10 008610025
1,2x8	25	1,85	+	+	10 008610028
1,6x8	25	1,85	+	+	10 008610030

861PH

inserti per avvitatori per viti con impronta a croce Phillips®



ISO 2351-2

ISO 1173 C 6,3

PH	L mm	€	Icona	Icona	Descrizione
0	25	0,93	+	+	10 008610200
1	25	0,93	+	+	10 008610205
2	25	0,93	+	+	10 008610210
2L	50	1,85	+	+	10 008610213
3	25	0,93	+	+	10 008610215
4	25	2,55	+	+	10 008610220

861PH/C

inserti per avvitatori per viti con impronta a croce Phillips®



ISO 2351-2

ISO 1173 C 6,3

PH	L mm	€	Icona	Icona	Descrizione
0	25	0,67	+	+	200 008610250
1	25	0,67	+	+	200 008610255
2	25	0,67	+	+	200 008610260
2L	50	1,36	+	+	100 008610263
3	25	0,67	+	+	200 008610265
4	25	1,85	+	+	100 008610270

861PZ

inserti per avvitatori per viti con impronta a croce Pozidriv® - Supadriv®



ISO 2351-2

ISO 1173 C 6,3

PZ	L mm	€	Icona	Icona	Descrizione
1	25	0,93	+	+	10 008610300
2	25	0,93	+	+	10 008610305
2L	50	1,85	+	+	10 008610308
3	25	0,93	+	+	10 008610310
4	25	2,55	+	+	10 008610315

861PZ/C

inserti per avvitatori
per viti con impronta a croce
Pozidriv® - Supadriv®



ISO 2351-2
ISO 1173 C 6,3

PZ	L mm	€		
1	25	0,67	200	008610350
2	25	0,67	200	008610355
2L	50	1,36	100	008610358
3	25	0,67	200	008610360
4	25	1,85	100	008610365

861PE

inserti maschio esagonale
per avvitatori



ISO 2351-3
ISO 1173 C 6,3

mm	L mm	€		
2	25	1,00	10	008610100
2,5	25	1,00	10	008610105
3	25	1,00	10	008610110
4	25	1,00	10	008610115
5	25	1,00	10	008610120
6	25	1,00	10	008610125
8	25	1,55	10	008610130
10	25	2,00	10	008610135

861TX

inserti per avvitatori
per viti con impronta Torx®



ISO 1173 C 6,3

T	L mm	€		
T6	25	1,37	10	008610400
T7	25	1,37	10	008610405
T8	25	1,37	10	008610410
T9	25	1,37	10	008610415
T10	25	1,06	10	008610420
T15	25	1,06	10	008610425
T20	25	1,06	10	008610430
T25	25	1,06	10	008610435
T27	25	1,06	10	008610440
T30	25	1,06	10	008610445
T40	25	1,06	10	008610450

861TX/C

inserti per avvitatori
per viti con impronta Torx®

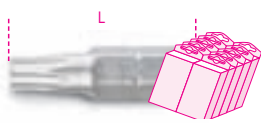

ISO 1173 C 6,3

T	L mm	€		
T10	25	0,77	200	008610470
T15	25	0,77	200	008610475
T20	25	0,77	200	008610480
T25	25	0,77	200	008610485
T27	25	0,77	200	008610490
T30	25	0,77	200	008610495
T40	25	0,77	200	008610499

861RTX

inserti per avvitatori per viti
con impronta Tamper Resistant Torx®



ISO 1173 C 6,3

T	L mm	€		
T9	25	2,00	10	008610500
T10	25	2,00	10	008610505
T15	25	2,00	10	008610510
T20	25	2,00	10	008610515
T25	25	2,00	10	008610520
T27	25	2,00	10	008610525
T30	25	2,00	10	008610530
T40	25	2,00	10	008610535

861TRW

inserti per avvitatori
per viti con impronta Tri-Wing®



ISO 1173 C 6,3

GR	L mm	€		
1	25	1,61	10	008610601
2	25	1,61	10	008610602
3	25	1,61	10	008610603
4	25	1,61	10	008610604
5	25	1,61	10	008610605
6	25	2,39	10	008610606

861TQS

inserti per avvitatori
per viti con impronta Torq-Set®



ISO 1173 C 6,3

GR	L mm	€		
0	25	1,61	10	008610620
1	25	1,61	10	008610621
2	25	1,61	10	008610622
3	25	1,61	10	008610623
4	25	1,61	10	008610624
5	25	1,61	10	008610625
6	25	1,61	10	008610626
8	25	1,61	10	008610628
10	25	1,61	10	008610630

861SP

inserti per avvitatori per viti con impronta
Spanner



ISO 1173 C 6,3

SP	D mm	L mm	€		
4	1,5	25	1,21	10	008610650
6	2,4	25	1,21	10	008610653
8	2,8	25	1,21	10	008610656
10	3,3	25	1,21	10	008610658
12	3,9	25	1,21	10	008610660

861/C61P

61 inserti per avvitatori e 1 portainseriti
magnetico a sgancio rapido



861/C61P € 117,50 1 008610978

	861LP	0,5x3 - 0,6x4,5 - 0,8x5,5 - 1,0x5,5 1,2x6,5 - 1,2x8 - 1,6x8 mm
	861PE	2 - 2,5 - 3 - 4 - 5 - 6 - 8 - 10 mm
	861PH	PH0 - PH1 - PH2 - PH3
	861PZ	PZ1 - PZ2 - PZ3
	861TX	T6 - T7 - T8 - T9 - T10 - T15 T20 - T25 - T27 - T30 - T40
	861RTX	T9 - T10 - T15 - T20 - T25 T27 - T30 - T40
	861TRW	1 - 2 - 3 - 4 - 5 - 6
	861TQS	0 - 1 - 2 - 3 - 4 - 5 - 6 - 8 - 10
	861SP	4 - 6 - 8 - 10 - 12
	851SR	○ 1/4"

270x120x45 mm - 975 g

862LP

inserti per avvitatori
per viti a testa con intaglio



ISO 2351-1

ISO 1173 E 6,3

SxA mm	L mm	€		
0,5x3	50	2,80	5	008620005
0,6x4,5	50	2,80	5	008620010
0,8x5,5	50	2,80	5	008620015
1x5,5	50	2,80	5	008620020
1,2x6,5	50	2,80	5	008620025
1,2x8	50	3,50	5	008620030
1,6x8	50	3,50	5	008620035

862PH

inserti per avvitatori
per viti con impronta a croce Phillips®



ISO 2351-2

ISO 1173 E 6,3

PH	L mm	€		
1	50	2,80	5	008620200
2	50	2,80	5	008620205
3	50	2,80	5	008620210

862PH/L

inserti per avvitatori per viti con impronta a croce Phillips®



ISO 2351-2

ISO 1173 E 6,3

PH	L mm	€	🔧	📦
1	70	5,20	5	008620230
2	70	5,20	5	008620232
3	70	5,20	5	008620234

862PZ

inserti per avvitatori per viti con impronta a croce Pozidriv® - Supadriv®



ISO 2351-2

ISO 1173 E 6,3

PZ	L mm	€	🔧	📦
1	50	2,90	5	008620300
2	50	2,90	5	008620305
3	50	2,90	5	008620310

862PE

inserti maschio esagonale per avvitatori



ISO 2351-3

ISO 1173 E 6,3

mm	L mm	€	🔧	📦
3	50	2,90	5	008620103
4	50	2,90	5	008620104
5	50	2,90	5	008620105
6	50	2,90	5	008620106
8	50	3,90	5	008620108

862TX

inserti per avvitatori per viti con impronta Torx®



ISO 1173 E 6,3

⊖	L mm	€	🔧	📦
T9	50	3,80	5	008620509
T10	50	3,80	5	008620510
T15	50	3,80	5	008620515
T20	50	3,80	5	008620520
T25	50	3,80	5	008620525
T27	50	3,80	5	008620527
T30	50	3,80	5	008620530
T40	50	3,80	5	008620540

862TX/L

inserti per avvitatori per viti con impronta Torx®



ISO 1173 E 6,3

⊖	L mm	€	🔧	📦
T9	70	4,20	5	008620559
T10	70	4,20	5	008620560
T15	70	4,20	5	008620565
T20	70	4,20	5	008620570
T25	70	4,20	5	008620575
T27	70	4,20	5	008620577
T30	70	4,20	5	008620580
T40	70	4,20	5	008620590

862F

inserti per avvitatori chiavi a bussola esagonale magnetici



ISO 1173 E 6,3

mm	L mm	∅ mm	€	🔧	📦
5,5	65	11	4,70	5	008620405
6	65	11	4,70	5	008620406
7	65	11	4,70	5	008620407
8	65	13	4,70	5	008620408
10	65	15	5,30	5	008620410
12	65	18	5,80	5	008620412
13	65	18	6,30	5	008620413

862F/A7

7 inserti per avvitatori chiavi a bussola esagonale magnetici, in astuccio tascabile



862F/A7 36,00 1 008620950

862F 5,5-6-7-8-10-12-13 mm

866LP

inserti per avvitatori per viti a testa con intaglio



ISO 2351-1

⊖	SxA mm	L mm	€	🔧	📦
ISO 1173 C 8					
1x5,5	41	2,90	10	008660005	
1,2x6,5	41	2,90	10	008660010	
1,6x8	41	2,90	10	008660015	
1,6x10	41	3,90	10	008660020	
2x12	41	4,90	10	008660025	

866PH

inserti per avvitatori per viti con impronta a croce Phillips®



ISO 2351-2

ISO 1173 C 8

PH	L mm	€	🔧	📦
1	32	2,30	10	008660200
2	32	2,30	10	008660205
3	32	2,30	10	008660210
4	38	3,50	10	008660215

866PZ

inserti per avvitatori per viti con impronta a croce Pozidriv® - Supadriv®



ISO 2351-2

ISO 1173 C 8

PZ	L mm	€	🔧	📦
1	32	2,40	10	008660300
2	32	2,40	10	008660305
3	32	2,40	10	008660310
4	38	3,60	10	008660315

866PE

inserti maschio esagonale per avvitatori



ISO 2351-3

ISO 1173 C 8

mm	L mm	€	🔧	📦
3	30	2,00	10	008660100
4	30	2,00	10	008660105
5	30	2,00	10	008660110
6	30	2,00	10	008660115
8	30	2,00	10	008660120
10	30	2,80	10	008660125

866TX

inserti per avvitatori per viti con impronta Torx®



ISO 1173 C 8

⊖	L mm	€	🔧	📦
T20	30	2,50	10	008660400
T25	30	2,50	10	008660405
T27	30	2,50	10	008660410
T30	30	2,50	10	008660415
T40	30	2,50	10	008660420
T45	30	2,50	10	008660425
T50	30	2,50	10	008660430
T55	30	3,60	10	008660435

867PE

inserti maschio esagonale



mm	L mm	€	5	10
4	30	1,15	5	008670104
5	30	1,15	5	008670105
6	30	1,15	5	008670106
7	30	1,15	5	008670107
8	30	1,15	5	008670108
10	30	1,15	5	008670110
12	30	1,65	5	008670112

867PE/L

inserti maschio esagonale



mm	L mm	€	5	10
4	75	2,10	5	008670154
5	75	2,10	5	008670155
6	75	2,10	5	008670156
7	75	2,10	5	008670157
8	75	2,10	5	008670158
10	75	2,10	5	008670160
12	75	3,00	5	008670162

867XZN

inserti a profilo XZN®



Ø	L mm	€	5	10
M5	30	1,40	5	008670205
M6	30	1,40	5	008670206
M8	30	1,40	5	008670208
M10	30	1,40	5	008670210
M12	30	1,90	5	008670212

867XZN/L

inserti a profilo XZN®



Ø	L mm	€	5	10
M5	75	2,30	5	008670255
M6	75	2,30	5	008670256
M8	75	2,30	5	008670258
M10	75	2,30	5	008670260
M12	75	3,20	5	008670262

867TX

inserti per viti con impronta Torx®



Ø	L mm	€	5	10
T20	30	1,15	5	008670400
T25	30	1,15	5	008670405
T30	30	1,15	5	008670410
T40	30	1,15	5	008670415
T45	30	1,15	5	008670420
T50	30	1,15	5	008670425
T55	30	1,15	5	008670430

867TX/L

inserti per viti con impronta Torx®



Ø	L mm	€	5	10
T20	75	1,90	5	008670450
T25	75	1,90	5	008670455
T30	75	1,90	5	008670460
T40	75	1,90	5	008670465
T45	75	1,90	5	008670470
T50	75	1,90	5	008670475
T55	75	1,90	5	008670480

867RTX

inserti per viti con impronta
Tampor Resistant Torx®



Ø	L mm	€	5	10
T20	30	1,30	5	008670500
T25	30	1,30	5	008670505
T30	30	1,30	5	008670510
T40	30	1,30	5	008670515
T45	30	1,30	5	008670520
T50	30	1,30	5	008670525
T55	30	1,30	5	008670530

867RTX/L

inserti per viti con impronta
Tampor Resistant Torx®



Ø	L mm	€	5	10
T20	75	2,20	5	008670550
T25	75	2,20	5	008670555
T30	75	2,20	5	008670560
T40	75	2,20	5	008670565
T45	75	2,20	5	008670570
T50	75	2,20	5	008670575
T55	75	2,20	5	008670580

867/...

bussole portainseriti per 867



867/1	10	3/8"	38	17	€	5	10
867/2	10	1/2"	38	22	4,50	5	008670601

867/C52

52 inserti con attacco esagonale 10 mm
e 2 accessori

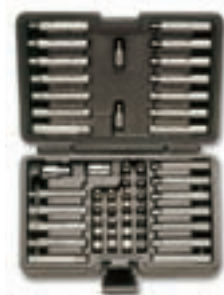

867/C52	€	1	10
	99,50	1	008670901

867PE	4-5-6-7-8-10-12 mm
867PE/L	4-5-6-7-8-10-12 mm
867XZN	M5-M6-M8-M10-M12
867XZN/L	M5-M6-M8-M10-M12
867TX	T20-T25-T30-T40-T45-T50-T55
867TX/L	T20-T25-T30-T40-T45-T50-T55
867RTX	T20-T25-T30-T40-T45-T50-T55
867RTX/L	T20-T25-T30-T40-T45-T50-T55
867/1	Ø 10 mm - □ 3/8"
867/2	Ø 10 mm - □ 1/2"

250x170x70 mm - 2,1 kg

882

portainseriti con anello di ritengo
per avvitatori



ISO 1173 C 6,3

L mm	Ø	€	5	10
57	1/4	13,00	5	008820001

882M1

portainseriti magnetico
per avvitatori



ISO 1173 C 6,3

L mm	Ø	€	5	10
50	1/4	13,60	5	008820006

882M

portainseri magnetico
per avvitatori



ISO 1173 C 6,3

L mm	○ 1/4	● 1/4	Ø mm	€	📦	📄
75			11	16,60	5	008820005

882 MSR

portainseri magnetico a sgancio rapido per
avvitatori

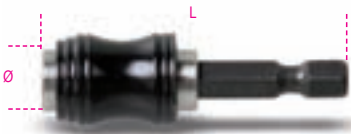

L mm	○ 1/4	● 1/4	Ø mm	€	📦	📄
50			11	14,00	5	008820205
75			11	16,60	5	008820207

882P

prolunga portainseri magnetica



L mm	● 1/4	○ 1/4	Ø mm	€	📦	📄
80			10	12,00	5	008820080

892

raccordi per avvitatori



	■ 1/4	● 1/4	L mm	€	📦	📄
892/0			25	4,30	5	008920000
* 892/1			50	7,90	5	008920001
* 892/2			50	12,00	5	008920002
° 892/3			50	7,90	5	008920003
° 892/4			50	12,00	5	008920004
892/5			75	11,20	5	008920005
892/6			75	16,60	5	008920006

* ISO 1173 A 5,5
° ISO 1173 C 6,3

895

bussole portainseri
per 860, 861, 862, 866



DIN 7427

	○	□	L mm	Ø mm	€	📦	📄
895/1	1/4	1/4	22	12	9,60	5	008950000
895/3	1/4	3/8	30	17,3	11,40	5	008950001
895/4	5/16	3/8	38	18	11,40	5	008950002
895/5	1/4	1/2	38	22	11,40	5	008950005
895/6	5/16	1/2	38	22	11,40	5	008950003

897

portainseri flessibile
con impugnatura



L mm	L1 mm	€	📦	📄
280	154	21,00	2	008970010

897L

portainseri flessibile con impugnatura
modello lungo



L mm	L1 mm	€	📦	📄
500	380	25,00	2	008970015

900

chiavi a bussola a mano
bocca esagonale



UNI/ISO 2725 DIN 3124

Ø mm	Ø mm	L mm	Ø1 mm	€	📦	📄
4	6,8	25	11,8	3,10	10	009000040
4,5	7,4	25	11,8	3,10	10	009000045
5	8,0	25	11,8	3,10	10	009000050
5,5	8,7	25	11,8	3,10	10	009000055
6	9,3	25	11,8	3,10	10	009000060
7	10,4	25	11,8	3,10	10	009000070
8	11,8	25	12,7	3,10	10	009000080
9	12,7	25	11,8	3,10	10	009000090
10	14,2	25	12,0	3,10	10	009000100
11	15,8	25	12,5	3,10	10	009000110
12	17,2	25	13,5	3,10	10	009000120
13	18,0	25	13,5	3,10	10	009000130
14	20,0	25	15,0	3,10	10	009000140



900/SB13	€	📦	📄
4-4,5-5-5,5-6-7-8-9 10-11-12-13-14 mm	52,00	1	009000150

900MB

chiavi a bussola a mano
bocca poligonale



UNI/ISO 2725 DIN 3124

Ø mm	Ø mm	L mm	Ø1 mm	€	📦	📄
4	7,7	22	11,2	6,00	5	009000160
5	8,0	25	11,8	6,00	5	009000161
5,5	8,7	25	11,8	6,00	5	009000162
6	9,3	25	11,8	6,00	5	009000163
7	10,4	25	11,8	6,00	5	009000164
8	11,8	25	12,7	6,00	5	009000165
9	12,7	25	11,8	6,00	5	009000166
10	14,2	25	12,0	6,00	5	009000167
11	15,8	25	12,5	6,00	5	009000168
12	17,2	25	13,5	6,00	5	009000169
13	18,0	25	13,5	6,70	5	009000170
14	20,0	25	15,0	7,10	5	009000171



900MB/SB12	€	📦	📄
4-5-5,5-6-7-8-9-10 11-12-13-14 mm	85,00	1	009000179

900L

chiavi a bussola a mano lunghe
bocca esagonale



UNI/ISO 2725 DIN 3124

Ø mm	Ø mm	L mm	Ø1 mm	€	📦	📄
4	6,5	50	12,0	7,40	5	009000181
4,5	7,0	50	12,0	7,40	5	009000182
5	7,5	50	12,0	7,40	5	009000183
5,5	8,5	50	12,0	7,40	5	009000184
6	9,5	50	12,0	7,40	5	009000185
7	10,5	50	12,0	7,40	5	009000186
8	12,0	50	12,0	7,40	5	009000187
9	13,0	50	13,0	7,40	5	009000188
10	14,0	50	14,0	7,80	5	009000189
11	16,0	50	16,0	7,80	5	009000190
12	17,5	50	17,5	7,80	5	009000191
13	17,5	50	17,5	7,80	5	009000192
14	20,0	50	20,0	7,80	5	009000193



900L/SB13	€	📦	📄
4-4,5-5-5,5-6-7-8-9-10-11-12-13-14 mm	110,00	1	009000203

900MB/L

chiavi a bussola a mano lunghe
bocca poligonale



UNI/ISO 2725 DIN 3124

Ø mm	Ø mm	L mm	Ø1 mm	€	🔧	📦
5	8,0	50	12,0	11,20	5	009000211
6	9,3	50	12,0	11,20	5	009000212
7	10,9	50	12,0	11,20	5	009000213
8	11,6	50	12,0	11,20	5	009000214
9	13,0	50	12,0	11,20	5	009000215
10	14,3	50	12,8	11,90	5	009000216
11	16,0	50	14,2	11,90	5	009000217
12	17,4	50	15,5	11,90	5	009000218
13	18,0	50	16,2	11,90	5	009000219
14	19,0	50	17,1	11,90	5	009000220

900AS

chiavi a bussola a mano
bocca esagonale



Ø mm	L mm	Ø1 mm	€	🔧	📦	
5/32	8,8	22	11,2	3,40	5	009000349
3/16	7,7	22	11,2	3,40	5	009000340
7/32	8,8	22	11,2	3,40	5	009000345
1/4	9,6	22	11,2	3,40	5	009000350
9/32	10,2	22	11,2	3,40	5	009000355
5/16	11,3	22	11,7	3,40	5	009000360
11/32	12,7	22	11,6	3,40	5	009000365
3/8	14,0	22	12,9	3,40	5	009000370
7/16	15,3	22	14,5	3,40	5	009000375
1/2	17,5	22	16,4	3,40	5	009000380
9/16	19,0	24	17,9	3,40	5	009000385



900AS/SB11 €47,50 1 009000389
3/16-7/32-5/32-1/4-9/32-5/16-11/32-3/8-
7/16-1/2-9/16

900AS/MB

chiavi a bussola a mano
bocca poligonale



SAE AS 954E

Ø mm	L mm	Ø1 mm	€	🔧	📦	
3/16	8,0	22	10,0	6,00	5	009000390
7/32	8,6	22	10,0	6,00	5	009000391
1/4	9,6	22	10,0	6,00	5	009000392
9/32	10,0	22	10,0	6,00	5	009000393
5/16	11,9	22	11,9	6,00	5	009000394
11/32	12,0	22	12,0	6,00	5	009000395
3/8	13,9	22	13,9	6,50	5	009000396
7/16	15,2	22	15,2	6,50	5	009000397
1/2	17,2	22	17,2	7,10	5	009000398
9/16	19,0	24	19,0	7,10	5	009000399

900AS/L

chiavi a bussola a mano lunghe
bocca esagonale



Ø mm	L mm	Ø1 mm	€	🔧	📦	
3/16	7,0	50	12,0	7,90	2	009000301
7/32	8,5	50	12,0	7,90	2	009000303
1/4	9,8	50	12,0	7,90	2	009000305
9/32	10,5	50	12,0	7,90	2	009000307
5/16	12,0	50	12,0	7,90	2	009000309
11/32	13,0	50	13,0	7,90	2	009000311
3/8	14,0	50	14,0	7,90	2	009000313
7/16	16,0	50	16,0	7,90	2	009000315
1/2	17,5	50	17,5	7,90	2	009000317
9/16	20,0	50	20,0	8,30	2	009000319

900AS/MBL

chiavi a bussola a mano lunghe
bocca poligonale

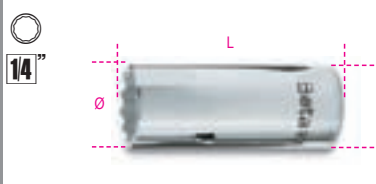

Ø mm	L mm	Ø1 mm	€	🔧	📦	
5/32	6,8	50	12,0	11,80	5	009000325
3/16	8,0	50	12,0	11,80	5	009000326
7/32	8,5	50	12,0	11,80	5	009000327
1/4	9,8	50	12,0	11,80	5	009000328
9/32	10,9	50	12,0	11,80	5	009000329
5/16	11,6	50	12,0	11,80	5	009000330
11/32	13,0	50	12,0	11,80	5	009000331
3/8	14,3	50	12,8	12,90	5	009000332
7/16	16,0	50	14,2	12,90	5	009000333
1/2	18,0	50	16,2	12,90	5	009000334
9/16	19,0	50	17,1	12,90	5	009000335

900FTX

chiavi a bussola a mano per viti
con teste a profilo Torx®

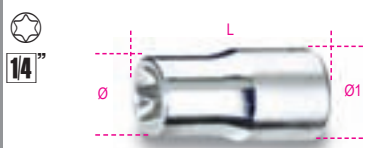

Ø mm	L mm	Ø1 mm	€	🔧	📦	
E4	5,4	22	11,2	5,50	5	009000404
E5	6,7	22	11,2	5,50	5	009000405
E6	7,7	22	11,2	5,50	5	009000406
E7	8,3	22	11,2	5,50	5	009000407
E8	9,6	22	11,2	5,50	5	009000408
E10	11,3	22	12,0	5,50	5	009000410
E11	12,1	22	12,5	7,00	5	009000411
E12	12,9	23	12,9	7,00	5	009000412
E14	14,0	25	14,0	7,00	5	009000414



900FTX/SB9 €63,00 1 009000419
E4-E5-E6-E7-E8
E10-E11-E12-E14

900LP

chiavi a bussola a giravite
per viti con intaglio



SxA mm	Ø mm	L mm	L1 mm	€	🔧	📦
0,8x4	12	28	9	6,70	10	009000605
1x5,5	12	28	9	6,70	10	009000610
1,2x6,5	12	28	9	6,70	10	009000615
1,2x8	13	28	8	6,70	10	009000620
1,6x10	14	28	8	6,70	10	009000625

900PH

chiavi a bussola a giravite
per viti con impronta a croce Phillips®



PH	Ø mm	L mm	L1 mm	€	🔧	📦
1	12	28	12	7,20	10	009000701
2	12	28	12	7,20	10	009000702
3	12	28	12	7,20	10	009000703
4	13	28	11	7,20	10	009000704

900LPH/SB7



900LPH/SB7 €56,00 1 009000707

900LP 0,8x4 - 1x5,5 - 1,2x6,5 - 1,2x8

900PH PH1 - PH2 - PH3

900ME

chiavi a bussola a giravite
maschio esagonale



mm	Ø mm	L mm	L1 mm	€	🔧	📦
2,5	12	25	4,5	6,30	10	009000502
3	12	25	5,0	6,30	10	009000503
4	12	25	5,6	6,30	10	009000504
5	12	25	6,3	6,30	10	009000505
6	12	25	7,6	6,30	10	009000506
7	13	25	7,2	6,30	10	009000507
8	13	25	8,0	6,30	10	009000508
10	13	25	8,7	7,90	5	009000510



900ME/SB8 €60,00 1 009000518
2,5-3-4-5-6-7-8-10 mm

900PT

chiavi a bussola a giravite per viti con impronta pentalobata



	Ø	L	L1	€		
	mm	mm	mm			
PT10	12	28	12	14,50	5	009000750
PT15	12	28	12	14,50	5	009000755
PT20	12	28	12	14,50	5	009000760
PT25	12	28	12	14,50	5	009000765
PT27	12	28	12	14,50	5	009000767
PT30	12	28	12	14,50	5	009000770

900TX

chiavi a bussola a giravite maschio per viti con impronta Torx®



	Ø	L	L1	€		
	mm	mm	mm			
T9	12	28	12	9,90	5	009000720
T10	12	28	12	9,90	5	009000721
T15	12	28	12	9,90	5	009000722
T20	12	28	12	9,90	5	009000723
T25	12	28	12	9,90	5	009000724
T27	12	28	12	9,90	5	009000725
T30	12	28	12	9,90	5	009000726
T40	12	28	12	9,90	5	009000727

900/16

raccordo con attacco quadro femmina 1/4" e maschio 3/8"

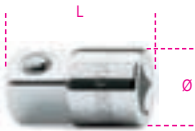

UNI/ISO 3316 DIN 3123

L	Ø		€		
mm	mm	1/4" 3/8"			
28	13,0		5,20	5	009000814

900/...

prolunghe con attacchi quadri maschio e femmina 1/4"

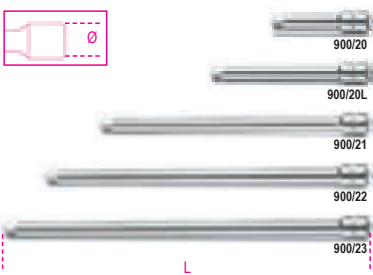

UNI/ISO 3316 DIN 3123

	L	Ø	€		
	mm	mm			
900/20	50	11,5	6,90	5	009000818
900/20L	100	11,5	7,10	5	009000819
900/21	150	11,5	7,40	5	009000822
900/22	250	11,5	11,00	5	009000823
900/23	350	11,5	13,00	5	009000824

900AN

prolunghe con attacchi quadri maschio e femmina 1/4" angolari

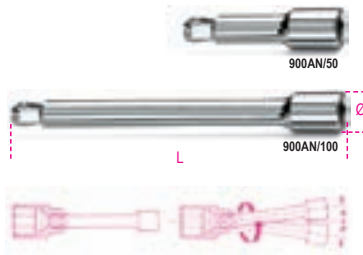

	L	Ø	€		
	mm	mm			
900AN/50	50	11,5	7,50	3	009000825
900AN/100	100	11,5	8,00	3	009000826

900FL

prolunga flessibile con attacchi quadri maschio e femmina 1/4"



L	Ø	€		
mm	mm			
150	12	10,90	3	009000828

900/25

snodo con attacchi quadri maschio e femmina 1/4"



UNI/ISO 3316 DIN 3123

L	Ø	€		
mm	mm			
41	12,5	13,70	5	009000830

900BG/30C

quadro maschio 1/4" con impugnatura



UNI/ISO 3315 DIN 3122

L	L1	€		
mm	mm			
128	20	5,50	5	009000833

900BG/30

quadro maschio 1/4" con impugnatura



UNI /ISO 3315 DIN 3122

L	L1	€		
mm	mm			
176	68	6,00	5	009000834

900/32

quadro maschio 1/4" flessibile con impugnatura



L	L1	€		
mm	mm			
280	154	14,50	2	009000839

900/35A

quadro maschio 1/4" snodato con impugnatura



UNI/ISO 3315 DIN 3122

L	L1	€		
mm	mm			
148	84	20,50	5	009000840

900M/35

quadro maschio 1/4" snodato con impugnatura in metallo



L	€		
mm			
130	27,00	3	009000845

900/40

quadro maschio 1/4" snodato a T



L	L1	€		
mm	mm			
390	145	28,00	5	009000843

900/42

quadro maschio 1/4" con spina scorrevole



UNI/ISO 3315 DIN 3122

L	A	€		
mm	mm			
115	22	7,50	5	009000854

900/55

cricchetto reversibile
con attacco quadro maschio 1/4"
meccanismo a 48 denti

14"

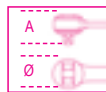

UNI/ISO 3315 DIN 3122

L	Ø	A	€	1	009000870
mm	mm	mm	35,50	5	
125	25	18			

900M/55

cricchetto reversibile
con attacco quadro maschio 1/4"
con impugnatura in metallo

14"



L	Ø	A	€	3	009000905
mm	mm	mm	45,00		
110	22	18			

900/C11

11 chiavi a bussola esagonali,
20 inserti per avvitatori e 8 accessori

14"



900/C11	€	1	009000971
	165,50		

	861LP	0,5x3 - 0,8x5,5 1x5,5 - 1,2x6,5 mm
	861PE	3 - 4 - 5 - 6 - 8 mm
	861PH	0 - 1 - 2 - 3
	861TX	T8 - T10 - T15 - T20 T25 - T30 - T40
	895/1	
	900	5 - 5,5 - 6 - 7 - 8 - 9 - 10 11 - 12 - 13 - 14 mm
	900/16	□ 1/4 - ■ 3/8
	900/20	50 mm
	900/21	150 mm
	900/25	
	900BG/30	
	900/42	
	900/55	

270x120x45 mm - 1,2 kg

900/C13-5

13 chiavi a bussola esagonali
e 5 accessori

14"



900/C13-5	€	1	009000953
	129,50		

	900	4 - 4,5 - 5 - 5,5 - 6 - 7 - 8 - 9 10 - 11 - 12 - 13 - 14 mm
	900/21	150 mm
	900/25	
	900BG/30	
	900/42	
	900/55	

270x120x45 mm - 1 kg

900/C13-8

13 chiavi a bussola esagonali
e 8 accessori

14"



900/C13-8	€	1	009000954
	162,00		

	900	4 - 4,5 - 5 - 5,5 - 6 - 7 - 8 - 9 10 - 11 - 12 - 13 - 14 mm
	900/16	□ 1/4 - ■ 3/8
	900/20	50 mm
	900/21	150 mm
	900/25	
	900BG/30	
	900/35A	
	900/42	
	900/55	

270x120x45 mm - 1,1 kg

900MB/C19

11 chiavi a bussola poligonali
e 8 accessori

14"



900MB/C19	€	1	009000977
	189,50		

	900MB	5 - 5,5 - 6 - 7 - 8 - 9 - 10 - 11 12 - 13 - 14 mm
	900/16	□ 1/4 - ■ 3/8
	900/20	50 mm
	900/21	150 mm
	900/25	
	900BG/30	
	900/35A	
	900/42	
	900/55	

270x120x45 mm - 1,1 kg

900/C24

13 chiavi a bussola esagonali
11 a giravite e 6 accessori

14"



900/C24	€	1	009000956
	209,50		

	900	4 - 4,5 - 5 - 5,5 - 6 - 7 - 8 - 9 10 - 11 - 12 - 13 - 14 mm
	900LP	0,8x4 - 1,2x6,5 - 1,2x8 mm
	900PH	PH1 - PH2 - PH3
	900ME	3 - 4 - 5 - 6 - 8 mm
	900/20	50 mm
	900/21	150 mm
	900/25	
	900BG/30	
	900/42	
	900/55	

270x120x45 mm - 1,1 kg

900MB/C28

11 chiavi a bussola poligonali
11 a giravite e 6 accessori

1/4"



900MB/C28 € 237,00 1 009000979

- 900MB 5 - 5,5 - 6 - 7 - 8 - 9 - 10 - 11 - 12 - 13 - 14 mm
 - 900LP 0,8x4 - 1,2x6,5 - 1,2x8 mm
 - ⊕ 900PH PH1 - PH2 - PH3
 - 900ME 3 - 4 - 5 - 6 - 8 mm
 - 900/20 50 mm
 - 900/21 150 mm
 - 900/25
 - 900BG/30
 - 900/42
 - ⊕ 900/55
- ≡ 270x120x45 mm - 1,1 kg

900AS/C10 - /MB-C17

10 chiavi a bussola
e 7 accessori

1/4"



900AS/C10 € 150,50 1 009000961

- 900AS 3/16 - 7/32 - 1/4 - 9/32 - 5/16 - 11/32 - 3/8 - 7/16 - 1/2 - 9/16
 - 900/20 50 mm
 - 900/21 150 mm
 - 900/25
 - 900BG/30
 - 900/35A
 - 900/42
 - ⊕ 900/55
- ≡ 270x120x45 mm - 1,1 kg

900AS/MB-C17 € 179,50 1 009000981

- 900AS/MB 3/16 - 7/32 - 1/4 - 9/32 - 5/16 - 11/32 - 3/8 - 7/16 - 1/2 - 9/16
 - 900/20 50 mm
 - 900/21 150 mm
 - 900/25
 - 900BG/30
 - 900/35A
 - 900/42
 - 900/55
- ≡ 270x120x45 mm - 1,1 kg

900AS/C17-MBM

10 chiavi a bussola poligonali
e 7 accessori
per manutenzioni aeronautiche

1/4"



900AS/C17-MBM € 195,50 1 009000982

- 900AS/MB 3/16 - 7/32 - 1/4 - 9/32 - 5/16 - 11/32 - 3/8 - 7/16 - 1/2 - 9/16
 - 900/20 50 mm
 - 900/21 150 mm
 - 900/25
 - 900BG/30
 - 900M/35
 - 900/42
 - 900M/55
- ≡ 270x120x45 mm - 1,2 kg

902R/C6

6 raccordi per chiavi a bussola



902R/C6 € 69,50 1 009020814

- 900/16 □ 1/4 - ■ 3/8
 - 910/15 □ 3/8 - ■ 1/4
 - 910/16 □ 3/8 - ■ 1/2
 - 920/15 □ 1/2 - ■ 3/8
 - 920/16 □ 1/2 - ■ 3/4
 - 928/15 □ 3/4 - ■ 1/2
- ≡ 170x100x35 mm - 600 g

910A

chiavi a bussola a mano
bocca esagonale

3/8"



UNI/ISO 2725 DIN 3124

mm	Ø mm	L mm	Ø1 mm	€	1
6	9,5	28	16,7	5,30	5 009100006
7	10,7	28	16,7	5,30	5 009100007
8	12,1	28	16,7	5,30	5 009100008
9	13,2	28	16,7	5,30	5 009100009
10	14,6	29	16,7	5,30	5 009100010
11	15,8	29	16,7	5,30	5 009100011
12	17,2	30	17,7	5,60	5 009100012

mm	Ø mm	L mm	Ø1 mm	€	1
13	18,4	31	17,0	5,60	5 009100013
14	19,7	32	17,5	5,60	5 009100014
15	20,9	32	18,0	5,60	5 009100015
16	22,2	33	18,5	6,40	5 009100016
17	23,2	33	19,0	6,40	5 009100017
18	24,7	34	20,0	6,40	5 009100018
19	25,8	35	21,0	6,40	5 009100019
20	27,2	35	22,0	6,80	5 009100020
21	28,2	36	23,0	6,80	5 009100021
22	29,7	37	24,0	7,00	5 009100022

3/8"

3/8"



910A/SB17 € 115,50 1 009100030

6-7-8-9-10-11-12
13-14-15-16-17
18-19-20-21-22 mm

910B

chiavi a bussola a mano
bocca poligonale

3/8"

3/8"

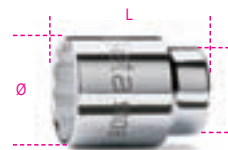

UNI/ISO 2725 DIN 3124

mm	Ø mm	L mm	Ø1 mm	€	1
6	9,5	28	16,7	5,30	5 009100106
7	10,7	28	16,7	5,30	5 009100107
8	12,1	28	16,7	5,30	5 009100108
9	13,2	28	16,7	5,30	5 009100109
10	14,6	29	16,7	5,30	5 009100110
11	15,8	29	16,7	5,30	5 009100111
12	17,2	30	17,7	5,60	5 009100112
13	18,4	31	17,0	5,60	5 009100113
14	19,7	32	17,5	5,60	5 009100114
15	20,9	32	18,0	5,60	5 009100115
16	22,2	33	18,5	6,40	5 009100116
17	23,2	33	19,0	6,40	5 009100117
18	24,7	34	20,0	6,40	5 009100118
19	25,8	35	21,0	6,40	5 009100119
20	27,2	35	22,0	6,80	5 009100120
21	28,2	36	23,0	6,80	5 009100121
22	29,7	37	24,0	7,00	5 009100122

3/8"

3/8"



910B/SB17 € 115,50 1 009100130

6-7-8-9-10-11-12
13-14-15-16-17
18-19-20-21-22 mm



910AL

chiavi a bussola a mano lunghe
bocca esagonale

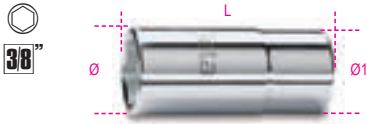

UNI/ISO 2725 DIN 3124

mm	Ø mm	L mm	Ø1 mm	€	5	10
8	12,0	55	17	10,80	5	009100158
9	13,0	55	17	10,80	5	009100159
10	14,5	55	17	10,80	5	009100160
11	16,0	55	17	10,80	5	009100161
12	17,0	55	17	10,80	5	009100162
13	18,0	55	17	11,80	5	009100163
14	20,0	55	18	11,80	5	009100164
15	21,0	55	20	11,80	5	009100165
16	22,0	55	20	11,80	5	009100166
17	23,5	55	22	11,80	5	009100167
18	24,5	55	23	12,90	5	009100168
19	25,0	55	24	12,90	5	009100169
21	27,0	65	26	14,10	5	009100171
22	29,0	65	28	14,10	5	009100172



910AL/SB14
8-9-10-11-12-13-14
15-16-17-18-19-21-22 mm

€ 180,00 1 009100174

910BL

chiavi a bussola a mano lunghe
bocca poligonale



UNI/ISO 2725 DIN 3124

mm	Ø mm	L mm	Ø1 mm	€	5	10
8	12,0	55	17	10,80	5	009100308
9	13,0	55	17	10,80	5	009100309
10	14,5	55	17	10,80	5	009100310
11	16,0	55	17	10,80	5	009100311
12	17,0	55	17	10,80	5	009100312
13	18,0	55	17	11,80	5	009100313
14	20,0	55	18	11,80	5	009100314
15	21,0	55	20	11,80	5	009100315
16	22,0	55	20	11,80	5	009100316
17	23,5	55	22	11,80	5	009100317
18	24,5	55	23	12,90	5	009100318
19	25,0	55	24	12,90	5	009100319
21	27,0	65	26	14,10	5	009100321
22	29,0	65	28	14,10	5	009100322



910BL/SB14
8-9-10-11-12-13
14-15-16-17-18
19-21-22 mm

€ 180,00 1 009100340

910B/SN

chiavi a bussola a mano snodate
bocca poligonale

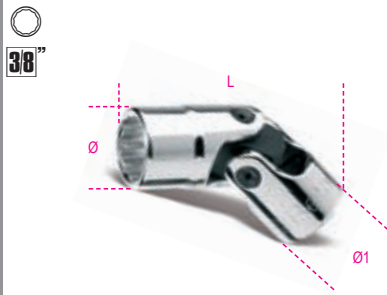

mm	Ø mm	L mm	Ø1 mm	€	5	10
10	14,5	48,5	19	26,50	5	009100230
11	15,8	49,5	19	26,50	5	009100231
12	17,0	50,0	19	26,50	5	009100232
13	18,3	51,0	19	26,50	5	009100233
14	19,5	51,0	19	29,50	5	009100234
15	20,8	53,5	19	29,50	5	009100235
16	22,0	53,5	19	29,50	5	009100236
17	23,3	54,5	19	29,50	5	009100237
18	24,5	54,5	19	29,50	5	009100238
19	25,8	56,5	19	29,50	5	009100239

910A/AS

chiavi a bussola a mano
bocca esagonale

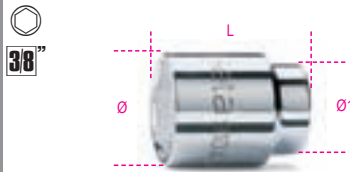

mm	Ø mm	L mm	Ø1 mm	€	5	10
1/4	10,3	26	17,3	6,30	5	009100276
5/16	11,9	26	17,3	6,30	5	009100278
11/32	13,3	26	17,3	6,30	5	009100279
3/8	13,9	26	17,3	6,30	5	009100280
7/16	15,8	26	17,3	6,30	5	009100281
1/2	17,9	26	17,3	6,60	5	009100283
9/16	19,5	27	18,5	6,60	5	009100284
19/32	20,6	27	19,5	6,60	5	009100285
5/8	21,9	28	20,0	7,20	5	009100286
11/16	24,6	30	22,5	7,20	5	009100287
3/4	25,9	30	23,5	7,20	5	009100289
13/16	27,9	32	26,0	8,00	5	009100291
7/8	29,6	32	26,5	8,50	5	009100292



910A-AS/SB13
1/4-5/16-11/32-3/8-7/16
1/2-9/16-19/32-5/8-11/16
3/4-13/16-7/8

€ 101,50 1 009100295

910AS

chiavi a bussola a mano
bocca poligonale

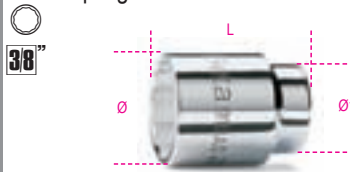

mm	Ø mm	L mm	Ø1 mm	€	5	10
1/4	9,5	28	16,7	6,30	5	009100201
5/16	12,1	28	16,7	6,30	5	009100202
11/32	13,2	28	16,7	6,30	5	009100203

mm	Ø mm	L mm	Ø1 mm	€	5	10
3/8	14,6	29	16,7	6,30	5	009100204
7/16	15,8	29	16,7	6,30	5	009100205
1/2	18,4	31	17,0	6,60	5	009100206
9/16	19,7	32	17,5	6,60	5	009100207
19/32	20,9	32	18,0	6,60	5	009100208
5/8	22,2	33	18,5	7,20	5	009100209
11/16	24,7	34	20,0	7,20	5	009100210
3/4	25,8	35	21,0	7,20	5	009100211
13/16	28,2	36	23,0	8,00	5	009100212
7/8	29,7	37	24,0	8,50	5	009100213



910AS/SB13
1/4-5/16-11/32-3/8-7/16
1/2-9/16-19/32-5/8-11/16
3/4-13/16-7/8

€ 101,50 1 009100215

910AS/L

chiavi a bussola a mano lunghe
bocca poligonale



mm	Ø mm	L mm	Ø1 mm	€	5	10
1/4	10	55	17	12,50	5	009100350
5/16	12	55	17	12,50	5	009100351
3/8	14	55	17	12,50	5	009100352
7/16	16	55	17	12,50	5	009100353
1/2	18	55	17	13,80	5	009100354
9/16	20	55	18	13,80	5	009100355
19/32	21	55	20	14,30	5	009100356
5/8	22	55	20	14,30	5	009100357
11/16	23	55	22	14,30	5	009100359
3/4	25	55	24	15,10	5	009100360
13/16	27	65	26	17,80	5	009100362
7/8	29	65	28	17,80	5	009100363



910ASL/SB12
1/4-5/16-3/8-7/16
1/2-9/16-19/32-5/8-11/16
3/4-13/16-7/8

€ 182,50 1 009100365

910AS/SN

chiavi a bussola a mano snodate
bocca poligonale

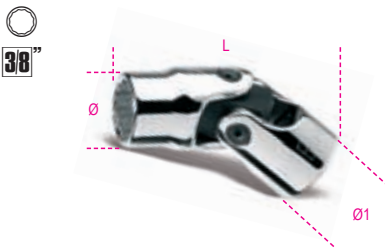

* SAE AS 954E

mm	Ø mm	L mm	Ø1 mm	€	5	10
* 3/8	14,0	48,0	19	29,50	5	009100260
* 7/16	15,8	51,0	19	29,50	5	009100261
* 1/2	18,3	51,0	19	29,50	5	009100262
* 9/16	19,5	51,0	19	29,50	5	009100263
* 5/8	22,0	53,5	19	29,50	5	009100264
11/16	24,5	54,5	19	31,00	5	009100265
3/4	25,8	56,5	19	31,00	5	009100266

910FTX

chiavi a bussola a mano per viti con testa a profilo Torx®



	Ø mm	L mm	Ø1 mm	€	Icon	Icon
E4	6,2	26	17,3	6,90	5	009100404
E5	7,0	26	17,3	6,90	5	009100405
E6	8,3	26	17,3	6,90	5	009100406
E7	8,9	26	17,3	6,90	5	009100407
E8	9,9	26	17,3	6,90	5	009100408
E10	12,0	26	17,3	6,90	5	009100410
E12	14,5	26	17,3	6,90	5	009100412
E14	15,8	26	17,3	6,90	5	009100414
E16	18,0	26	17,3	6,90	5	009100416



910FTX/SB9	€ 71,00	Icon	Icon	1	009100430
E4-E5-E6-E7-E8 E10-E12-14-E16					

910FTX/L

chiavi a bussola a mano lunghe per viti con testa a profilo Torx®



	Ø mm	L mm	Ø1 mm	€	Icon	Icon
E4	6,2	55	17,3	15,00	5	009100440
E5	7,0	55	17,3	15,00	5	009100441
E6	8,3	55	17,3	15,00	5	009100442
E7	8,9	55	17,3	15,00	5	009100443
E8	9,9	55	17,3	15,00	5	009100444
E10	12,0	55	17,3	15,00	5	009100445



910FTX/LSB6	€ 97,00	Icon	Icon	1	009100449
E4-E5-E6 E7-E8-E10					

910LP

chiavi a bussola a giravite per viti con intaglio



SxA mm	Ø mm	L mm	L1 mm	€	Icon	Icon
1x5,5	18,5	54	24	12,80	5	009100452
1,2x8	18,5	54	24	12,80	5	009100453
1,2x8	18,5	54	24	12,80	5	009100454
1,6x9	18,5	54	24	12,80	5	009100456

910PH

chiavi a bussola a giravite per viti con impronta a croce Phillips®



PH	Ø mm	L mm	L1 mm	€	Icon	Icon
1	18,5	48	18	11,50	5	009100471
2	18,5	48	18	11,50	5	009100472
3	18,5	48	18	11,50	5	009100473
4	18,5	48	18	11,50	5	009100474

910LH/SB7

chiavi a bussola a giravite per viti con intaglio e con impronta a croce Phillips®



910LH/SB7	€ 93,00	Icon	Icon	1	009100479
910LP 1x5,5 - 1,2x6,5 - 1,2x8 - 1,6x9 910PH PH1 - PH2 - PH3					

910PE

chiavi a bussola maschio esagonale



mm	Ø mm	L mm	L1 mm	€	Icon	Icon
3	18,5	50	20	9,70	5	009100490
4	18,5	50	20	9,70	5	009100492
5	18,5	50	20	9,70	5	009100494
6	18,5	50	20	9,70	5	009100496
7	18,5	50	20	9,70	5	009100497
8	18,5	50	20	9,70	5	009100498
10	18,5	50	20	9,70	5	009100500



910PE/SB7	€ 75,50	Icon	Icon	1	009100503
3-4-5-6-7-8-10 mm					

910ME

chiavi a bussola maschio esagonale



mm	Ø mm	L mm	L1 mm	€	Icon	Icon
4	18	62	15	11,70	5	009100504
5	18	62	15	11,70	5	009100505
6	18	62	15	11,70	5	009100506
7	18	62	15	11,70	5	009100507
8	19	62	15	11,70	5	009100508
10	20	62	15	11,70	5	009100510
12	20	62	15	11,70	5	009100512

910PT

chiavi a bussola a giravite per viti con impronta pentalobata



	Ø mm	L mm	L1 mm	€	Icon	Icon
PT40	20	50	20	16,00	3	009100540
PT45	20	50	20	16,50	3	009100545
PT50	20	50	20	17,00	3	009100550



910PT/SB8	€ 130,00	Icon	Icon	1	009100558
PT10-PT15-PT20-PT25 PT30-PT40-PT45-PT50					

910TX

chiavi a bussola maschio per viti con impronta Torx®



	Ø mm	L mm	L1 mm	€	Icon	Icon
T15	18,5	50	20	13,60	5	009100519
T20	18,5	50	20	13,60	5	009100520
T25	18,5	50	20	13,60	5	009100521
T27	18,5	50	20	13,60	5	009100522
T30	18,5	50	20	13,60	5	009100523
T40	18,5	50	20	13,60	5	009100524



910TX/SB6	€ 88,50	Icon	Icon	1	009100530
T15-T20-T25 T27-T30-T40					

910CF

chiavi a zampa di gallo



mm	A mm	L mm	€	Icon	Icon
10	21,3	32,3	7,60	5	009100135
11	23,1	34,3	7,60	5	009100136
12	25,5	36,2	9,40	5	009100137
13	26,9	37,4	9,40	5	009100138
14	30,2	40,0	10,20	5	009100139
15	33,3	41,3	10,40	5	009100140
16	33,3	41,3	11,50	5	009100141
17	38,1	46,5	13,80	5	009100142
18	38,1	46,5	13,80	5	009100143
19	39,6	48,0	14,30	5	009100144

3/8"

910CF/SB10
10-11-12-13-14-15
16-17-18-19 mm

€ 118,00 1 009100147

910/15

raccordo con attacco quadro femmina 3/8" e maschio 1/4"

3/8"

UNI/ISO 3316 DIN 3123

L mm	Ø mm	□	■	€	🔧	📄
30	17,0	3/8	1/4	7,30	5	009100810

! E' assolutamente necessario commisurare la coppia di serraggio alla capacità del quadro maschio per evitare rotture o danni accidentali

910/16

raccordo con attacco quadro femmina 3/8" e maschio 1/2"

3/8"

UNI/ISO 3316 DIN 3123

L mm	Ø mm	□	■	€	🔧	📄
32	18,0	3/8	1/2	7,30	5	009100814

910/21 - 910/22

prolunghe con attacchi quadri maschio e femmina 3/8"

3/8"

UNI/ISO 3316 DIN 3123

	L mm	Ø mm	€	🔧	📄
910/21	125	17	9,00	5	009100822
910/22	250	17	11,50	5	009100826

910AN

prolunghe con attacchi quadri maschio e femmina 3/8" angolari

3/8"

UNI/ISO 3316 DIN 3123

	L mm	Ø mm	€	🔧	📄
910AN/75	75	17	8,50	3	009100827
910AN/125	125	17	10,70	3	009100828
910AN/250	250	17	16,30	3	009100829

910/25

snodo con attacchi quadri maschio e femmina 3/8"

3/8"

UNI/ISO 3316 DIN 3123

L mm	Ø mm	€	🔧	📄
54,6	19	16,60	5	009100830

910M/35

quadro maschio 3/8" snodato con impugnatura in metallo

3/8"

UNI/ISO 3315 DIN 3122

L mm	€	🔧	📄
250	43,00	3	009100839

910/36A

quadro maschio 3/8" snodato con impugnatura

3/8"

UNI/ISO 3315 DIN 3122

L mm	L1 mm	€	🔧	📄
255	154	30,00	3	009100845

910/40

quadro maschio 3/8" snodato a T

3/8"

UNI/ISO 3315 DIN 3122

L mm	L1 mm	€	🔧	📄
420	175	31,00	3	009100850

910/42

quadro maschio 3/8" con spina scorrevole

3/8"

UNI/ISO 3315 DIN 3122

L mm	A mm	€	🔧	📄
210	30,5	10,50	5	009100854

910/46

quadro maschio 3/8" con manovella

3/8"

UNI/ISO 3315 DIN 3122

L mm	L1 mm	A mm	€	🔧	📄
315	80	115	19,00	1	009100862

910/55

cricchetto reversibile con attacco quadro maschio 3/8" meccanismo a 72 denti

3/8"

UNI/ISO 3315 DIN 3122

L mm	Ø mm	A mm	€	🔧	📄
200	30	33	38,50	3	009100882

910/55Q

cricchetto reversibile con attacco quadro maschio 3/8" meccanismo a 48 denti

3/8"

UNI/ISO 3315 DIN 3122

L mm	Ø mm	A mm	€	🔧	📄
200	30	33	38,50	3	009100885

910M/55

cricchetto reversibile con attacco quadro maschio 3/8" con impugnatura in metallo

3/8"

UNI/ISO 3315 DIN 3122

L mm	Ø mm	A mm	€	🔧	📄
178	30	26	53,00	2	009100875

910M/56

cricchetto reversibile snodato con attacco quadro maschio 3/8" con impugnatura in metallo

3/8"



L	Ø	A	€	1	009100887
mm	mm	mm	72,00	2	009100887
265	31	29			

910.../C10

10 chiavi a bussola e 2 accessori

3/8"



910A/C10	€	1	009100909
	122,50		

910A	6 - 7 - 8 - 10 - 11 - 12 13 - 14 - 17 - 19 mm
910/21	125 mm
910/55	
270x120x45 mm - 1,3 kg	

910B/C10	€	1	009100910
	122,50		

910B	6 - 7 - 8 - 10 - 11 - 12 13 - 14 - 17 - 19 mm
910/21	125 mm
910/55	
270x120x45 mm - 1,3 kg	

910A/C16...

16 chiavi a bussola esagonali e 5 accessori

3/8"



910A/C16	€	1	009100936
	202,50		

910A	6 - 7 - 8 - 9 - 10 - 11 - 12 - 13 14 - 15 - 16 - 17 - 18 - 19 21 - 22 mm
910/21	125 mm
910/22	250 mm
910/25	
910/42	
910/55	
335x145x60 mm - 2,3 kg	

910A/C16Q	€	1	009100932
	202,50		

910A	6 - 7 - 8 - 9 - 10 - 11 - 12 - 13 14 - 15 - 16 - 17 - 18 - 19 21 - 22 mm
910/21	125 mm
910/22	250 mm
910/25	
910/42	
910/55Q	
335x145x60 mm - 2,3 kg	

910B/C16...

16 chiavi a bussola poligonali e 5 accessori

3/8"



910B/C16	€	1	009100937
	202,50		

910B	6 - 7 - 8 - 9 - 10 - 11 - 12 - 13 14 - 15 - 16 - 17 - 18 - 19 21 - 22 mm
910/21	125 mm
910/22	250 mm
910/25	
910/42	
910/55	
335x145x60 mm - 2,3 kg	

910B/C16Q	€	1	009100933
	202,50		

910B	6 - 7 - 8 - 9 - 10 - 11 - 12 - 13 14 - 15 - 16 - 17 - 18 - 19 21 - 22 mm
910/21	125 mm
910/22	250 mm
910/25	
910/42	
910/55Q	
335x145x60 mm - 2,3 kg	

910A/C17

17 chiavi a bussola esagonali e 9 accessori

3/8"



910A/C17	€	1	009100938
	295,00		

910A	6 - 7 - 8 - 9 - 10 - 11 - 12 - 13 14 - 15 - 16 - 17 - 18 - 19 - 20 21 - 22 mm
910/15	□ 3/8 - ■ 1/4
910/16	□ 3/8 - ■ 1/2
910/21	125 mm
910/22	250 mm
910/25	
910/36A	
910/42	
910/46	
910/55	
420x280x60 mm - 4,0 kg	

910.../C29

17 chiavi a bussola e 12 a giravite e 5 accessori

3/8"



910A/C29	€	1	009100944
	346,00		

910A	6 - 7 - 8 - 9 - 10 - 11 - 12 - 13 14 - 15 - 16 - 17 - 18 - 19 - 20 21 - 22 mm
910LP	1x5,5 - 1,2x6,5 - 1,2x8 mm
910PH	PH1 - PH2 - PH3
910PE	3 - 4 - 5 - 6 - 8 - 10 mm
910/21	125 mm
910/22	250 mm
910/25	
910/42	
910/55	
420x185x60 mm - 3,5 kg	



910B/C29 € 346,00 1 009100945

- 910B 6 - 7 - 8 - 9 - 10 - 11 - 12 - 13
14 - 15 - 16 - 17 - 18 - 19 - 20
21 - 22 mm
 - 910LP 1x5,5 - 1,2x6,5 - 1,2x8 mm
 - ⊕ 910PH PH1 - PH2 - PH3
 - 910PE 3 - 4 - 5 - 6 - 8 - 10 mm
 - 910/21 125 mm
 - 910/22 250 mm
 - 910/25
 - 910/42
 - 910/55
- ≡ 420x185x60 mm - 📦 3,5 kg

910AS/C13...

13 chiavi a bussola poligonali
e 5 accessori

38"



910AS/C13 € 198,50 1 009100925

- 910AS 1/4 - 5/16 - 11/32 - 3/8 - 7/16
1/2 - 9/16 - 19/32 - 5/8 - 11/16
3/4 - 13/16 - 7/8
 - 910/21 125 mm
 - 910/22 250 mm
 - 910/42
 - 910/25
 - 910/55
- ≡ 335x145x60 mm - 📦 2,3 kg

910AS/MBM-C18

13 chiavi a bussola poligonali
e 5 accessori
per manutenzioni aeronautiche

38"



910AS/MBM-C18 € 213,00 1 009100926

- 910AS 1/4 - 5/16 - 11/32 - 3/8 - 7/16
1/2 - 9/16 - 19/32 - 5/8 - 11/16
3/4 - 13/16 - 7/8
 - 910/21 125 mm
 - 910/22 250 mm
 - 910/25
 - 910/42
 - 910M/55
- ≡ 335x145x60 mm - 📦 2,5 kg

920A

chiavi a bussola a mano
bocca esagonale

12"



UNI/ISO 2725 DIN 3124

Ø mm	Ø mm	L mm	Ø1 mm	€	📦	📦
8	12,4	38	21,7	5,20	10	009200008
9	13,5	38	21,7	5,20	10	009200009
10	14,9	38	21,7	5,20	10	009200010
11	16,1	38	21,7	5,20	10	009200011
12	17,5	38	21,7	5,20	10	009200012
13	18,7	38	21,7	5,70	10	009200013
14	20,1	38	21,7	5,70	10	009200014
15	21,5	38	22,5	5,70	10	009200015
16	22,7	38	23,7	6,20	10	009200016
17	24,1	38	23,1	6,20	10	009200017
18	25,3	39	24,0	6,20	10	009200018
19	26,6	39	24,0	6,20	10	009200019
20	27,8	40	25,0	7,20	5	009200020
21	28,8	40	25,0	7,20	5	009200021
22	29,9	41	26,0	7,20	5	009200022
23	30,8	42	26,0	7,90	5	009200023
24	32,2	43	27,0	7,90	5	009200024
25	33,2	44	27,0	7,90	5	009200025
26	34,7	45	28,0	8,20	5	009200026
27	36,2	46	29,0	8,20	5	009200027
28	37,2	47	30,0	8,20	5	009200028
29	38,6	48	31,0	8,90	5	009200029
30	40,2	48	32,0	8,90	5	009200030
32	42,3	49	34,0	9,20	5	009200032

12"



920A/SB13 € 91,50 1 009200040
10-11-12-13-14-15-16
17-18-19-20-21-22 mm

12"



920A/SB8 € 75,00 1 009200042
23-24-25-26-27-28-30-32 mm

920B

chiavi a bussola a mano
bocca poligonale

12"



UNI/ISO 2725 DIN 3124

Ø mm	Ø mm	L mm	Ø1 mm	€	📦	📦
8	12,4	38	21,7	5,20	10	009200108
9	13,5	38	21,7	5,20	10	009200109
10	14,9	38	21,7	5,20	10	009200110
11	16,1	38	21,7	5,20	10	009200111
12	17,5	38	21,7	5,20	10	009200112
13	18,7	38	21,7	5,70	10	009200113
14	20,1	38	21,7	5,70	10	009200114
15	21,5	38	22,5	5,70	10	009200115
16	22,7	38	23,7	6,20	10	009200116
17	24,1	38	23,1	6,20	10	009200117

Ø mm	Ø mm	L mm	Ø1 mm	€	📦	📦
18	25,3	39	24,0	6,20	10	009200118
19	26,6	39	24,0	6,20	10	009200119
20	27,8	40	25,0	7,20	5	009200120
21	28,8	40	25,0	7,20	5	009200121
22	29,9	41	26,0	7,20	5	009200122
24	32,2	43	27,0	7,90	5	009200124
25	33,2	44	27,0	7,90	5	009200125
26	34,7	45	28,0	8,20	5	009200126
27	36,2	46	29,0	8,20	5	009200127
28	37,2	47	30,0	8,20	5	009200128
29	38,6	48	31,0	8,90	5	009200129
30	40,2	48	32,0	8,90	5	009200130
32	42,3	49	33,9	9,20	5	009200132

12"



920B/SB13 € 91,50 1 009200140
10-11-12-13-14-15-16
17-18-19-20-21-22 mm

12"



920B/SB8 € 75,00 1 009200142
23-24-25-26-27
28-30-32 mm

920AL

chiavi a bussola a mano lunghe
bocca esagonale

12"



UNI/ISO 2725 DIN 3124

Ø mm	Ø mm	L mm	Ø1 mm	€	📦	📦
10	14,7	77	21	14,30	5	009200626
12	17,8	77	21	14,30	5	009200627
13	19,0	77	22	14,30	5	009200628
14	20,3	77	22	14,30	5	009200629
15	21,5	77	22	14,30	5	009200630
16	22,8	77	22	14,70	5	009200631
17	24,0	77	23	14,70	5	009200632
18	25,0	77	24	16,10	5	009200633
19	26,5	77	25	16,10	5	009200634
21	29,0	77	27	17,90	5	009200635
22	30,0	77	28	17,90	5	009200636
23	31,5	77	29	17,90	5	009200637
24	32,8	77	30	20,20	5	009200638
27	36,5	77	33	20,20	3	009200639
30	40,0	77	36	26,00	3	009200640
32	42,8	77	38	26,00	3	009200641
36	48,0	77	41	42,00	3	009200642

12"



920AL/SB11 € 179,50 1 009200644
10-12-13-14-15-16
17-18-19-21-22 mm

920BL

chiavi a bussola a mano lunghe
bocca poligonale

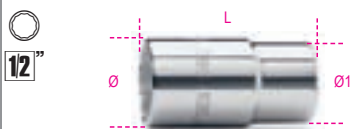

UNI/ISO 2725 DIN 3124

mm	Ø	L	Ø1	€		
10	14,7	77	21	14,30	5	009200310
12	17,8	77	21	14,30	5	009200312
13	19,0	77	22	14,30	5	009200313
14	20,3	77	22	14,30	5	009200314
15	21,5	77	22	14,30	5	009200315
16	22,8	77	22	14,70	5	009200316
17	24,0	77	23	14,70	5	009200317
18	25,0	77	24	16,10	5	009200318
19	26,5	77	25	16,10	5	009200319
21	29,0	77	27	17,90	5	009200321
22	30,0	77	28	17,90	5	009200322
23	31,5	77	29	17,90	5	009200323
24	32,8	77	30	20,20	5	009200324
27	36,5	77	33	20,20	3	009200327
30	40,0	77	36	26,00	3	009200330
32	42,8	77	38	26,00	3	009200332
36	48,0	77	41	42,00	3	009200336



920BL/SB11
10-12-13-14-15-16-17-18
19-21-22 mm
€ 179,50 1 009200338

920A/AS

chiavi a bussola a mano
bocca esagonale



mm	Ø	L	Ø1	€		
3/8	14,6	37	21	5,90	5	009200270
7/16	16,5	37	21	5,90	5	009200272
1/2	19,0	37	22	6,30	5	009200273
9/16	20,3	37	22	6,30	5	009200274
5/8	22,8	37	22	7,00	5	009200276
11/16	25,0	37	24	7,00	5	009200277
3/4	26,5	38	25	7,00	5	009200279
13/16	29,0	38	27	8,20	5	009200281
7/8	30,0	40	28	8,20	5	009200282
15/16	32,8	42	30	8,80	5	009200284
1	35,0	42	32	8,80	5	009200285
1.1/16	36,5	43	33	9,40	5	009200287
1.1/8	39,0	43	35	9,70	5	009200289
1.1/4	42,8	46	38	10,30	5	009200292



920A-AS/SB11
3/8-7/16-1/2-9/16-5/8
11/16-3/4-13/16-7/8
15/16-1
€ 90,00 1 009200295

920AS

chiavi a bussola a mano
bocca poligonale

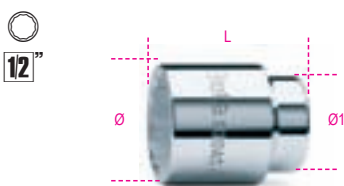

mm	Ø	L	Ø1	€		
3/8	14,9	38	21,7	5,90	5	009200201
7/16	16,1	38	21,7	5,90	5	009200202
1/2	18,7	38	21,7	6,30	5	009200203
9/16	20,1	38	21,7	6,30	5	009200204
5/8	22,7	38	22,5	7,00	5	009200206
19/32	21,5	38	23,7	7,00	5	009200207
11/16	25,3	39	24,0	7,00	5	009200208
3/4	26,6	39	24,0	7,00	5	009200209
25/32	27,8	40	25,0	8,20	5	009200210
13/16	28,8	40	25,0	8,20	5	009200211
7/8	29,9	41	26,0	8,20	5	009200212
15/16	32,2	43	27,0	8,80	5	009200214
1	34,2	45	28,0	8,80	5	009200216
1.1/16	36,2	46	29,0	9,40	5	009200217
1.1/8	38,6	48	31,0	9,70	5	009200218
1.3/16	40,2	48	32,0	10,30	5	009200219
1.1/4	42,3	49	33,5	10,30	5	009200220



920AS/SB11
3/8-7/16-1/2-9/16-5/8
11/16-3/4-13/16-7/8
15/16-1
€ 90,00 1 009200225

920AS/L

chiavi a bussola a mano lunghe
bocca poligonale



mm	Ø	L	Ø1	€		
1/2	19,0	77	22	18,00	2	009200352
9/16	20,3	77	22	18,00	2	009200353
5/8	22,8	77	22	18,00	2	009200355
11/16	25,0	77	24	18,00	2	009200357
3/4	26,5	77	25	19,80	2	009200358
13/16	29,0	77	27	23,00	2	009200360
7/8	30,0	77	28	23,00	2	009200361
15/16	32,8	77	30	23,00	2	009200362
1	35,0	77	32	25,00	2	009200363
1.1/16	36,5	77	33,0	26,00	2	009200364
1.1/8	37,8	77	34	27,00	2	009200365



920ASL/SB11
1/2-9/16-5/8-11/16
3/4-13/16-7/8-15/16
1-1.1/8-1.1/16
€ 249,50 1 009200369

920FTX

chiavi a bussola a mano per viti
con testa a profilo Torx®



mm	Ø	L	Ø1	€		
E10	13,2	36	21	7,50	5	009200380
E12	15,0	37	21	7,50	5	009200381
E14	16,3	37	21	7,50	5	009200382
E16	18,8	37	22	7,50	5	009200383
E18	20,4	37	22	7,50	5	009200384
E20	22,9	37	22	8,10	5	009200385
E22	25,0	37	24	9,60	5	009200387
E24	26,5	40	25	10,80	5	009200388



920FTX/SB6
E10-E12-E14
E16-E18-E20
€ 52,50 1 009200390



920FTX/C8
E10-E12-E14-E16
E18-E20-E22-E24
€ 85,00 1 009200391
270X120X45 mm - 1 kg

920FTX/L

chiavi a bussola a mano lunghe
per viti con testa a profilo Torx®



mm	Ø	L	Ø1	€		
E10	13,2	77	21,0	16,40	5	009200400
E12	15,0	77	21,0	16,40	5	009200401
E14	16,3	77	21,0	16,40	5	009200402
E16	18,8	77	21,8	16,40	5	009200403
E18	20,4	77	21,8	16,40	5	009200404
E20	22,9	77	22,0	16,40	5	009200405



920FTX/LSB6
E10-E12-E14
E16-E18-E20
€ 105,00 1 009200409

920LP

chiavi a bussola a giravite per viti con intaglio

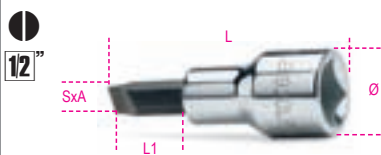

SxA mm	Ø mm	L mm	L1 mm	€	🔧	📦
1x5,5	22,5	62	24	14,00	5	009200452
1,2x6,5	22,5	62	24	14,00	5	009200453
1,2x8	22,5	62	24	14,00	5	009200454
1,6x9	22,5	62	24	14,00	5	009200456
2x12	22,5	62	24	14,00	5	009200458

920PH

chiavi a bussola a giravite per viti con impronta a croce Phillips®

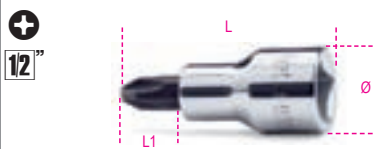

PH	Ø mm	L mm	L1 mm	€	🔧	📦
1	22,5	56	18	12,10	5	009200471
2	22,5	56	18	12,10	5	009200472
3	22,5	56	18	12,10	5	009200473
4	22,5	56	18	12,10	5	009200474

920LH/SB7

chiavi a bussola a giravite per viti con impronta a croce Phillips®



920LH/SB7 € 100,00 1 009200478

920LP	1,2x6,5 - 1,2x8
920PH	1,6x9 - 2x12 mm
	PH2 - PH3 - PH4

920PE

chiavi a bussola maschio esagonale

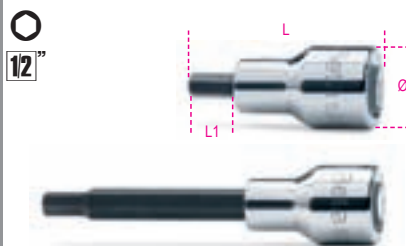

mm	Ø mm	L mm	L1 mm	€	🔧	📦
3	22,5	58	20	10,50	5	009200410
4	22,5	58	20	10,50	5	009200412
5	22,5	58	20	10,50	5	009200414
5L	22,5	100	62	11,20	5	009200415
6	22,5	58	20	10,50	5	009200417
6L	22,5	100	62	11,20	5	009200418
7	22,5	58	20	10,50	5	009200420
7L	22,5	100	62	11,20	5	009200421
8	22,5	58	20	10,50	5	009200423
8L	22,5	100	62	11,20	5	009200424
9	22,5	58	20	10,50	5	009200425
9L	22,5	140	102	11,20	5	009200426
10	22,5	58	20	10,50	5	009200428
10L	22,5	140	102	11,50	5	009200429
12	23,0	58	20	11,50	5	009200432
12L	22,5	140	102	12,50	5	009200433
14	23,0	58	20	11,80	5	009200434
14L	22,5	140	102	12,50	5	009200435
17	29,5	60	22	15,20	5	009200437
19	29,5	60	22	15,20	5	009200439



920PE/SB9 € 106,50 1 009200441
4-5-6-8-10 mm
5L-6L-8L-10L mm



920PE/C10 € 135,50 1 009200443
4-5-6-7-8-10
12-14-17-19 mm

≡ 270X120X45 mm - 1,5 kg

920PE/LS4

serie di 4 chiavi 920PE



6L-7L-8L-10L € 45,00 1 009200442

920PE/AS

chiavi a bussola maschio esagonale

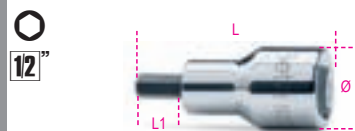

"	Ø mm	L mm	L1 mm	€	🔧	📦
1/8	22,5	58	20	12,30	2	009200460
3/16	22,5	58	20	12,30	2	009200461
1/4	22,5	58	20	12,30	2	009200463
3/8	22,5	58	20	12,30	2	009200464
1/2	22,5	60	20	12,30	2	009200465
3/4	22,5	60	20	12,30	1	009200468

920BP

chiavi a bussola maschio esagonale con estremità sferica

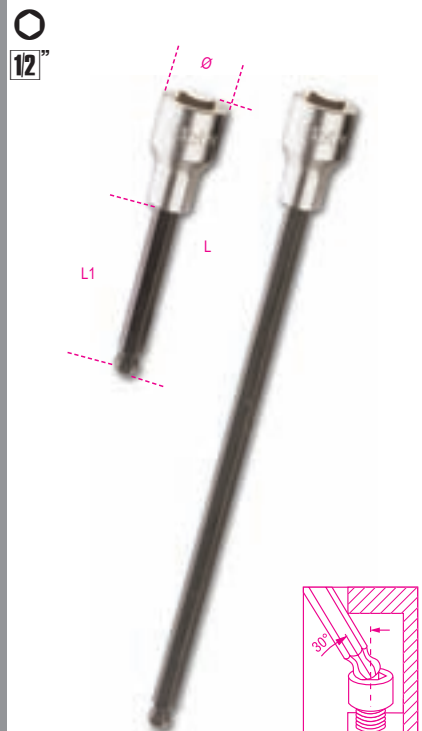

mm	Ø mm	L mm	L1 mm	€	🔧	📦
5L	22,5	100	62	13,00	5	009200490
5XL	22,5	240	202	16,30	1	009200495
6L	22,5	100	62	13,00	5	009200491
6XL	22,5	240	202	16,30	1	009200496
7L	22,5	100	62	13,00	5	009200492
8L	22,5	100	62	13,00	5	009200493
8XL	22,5	240	202	16,30	1	009200497
10L	22,5	140	102	13,00	5	009200494



920BP/SB8 € 122,50 1 009200500
5L-6L-7L-8L-10L mm
5XL-6XL-8XL mm



920ME

chiavi a bussola
maschio esagonale



mm	Ø mm	L mm	L1 mm	€	📦	📄
5	21	75	15,5	12,30	5	009200505
6	21	75	15,5	12,30	5	009200506
7	21	75	15,5	12,30	5	009200507
8	21	75	15,5	12,30	5	009200508
10	23	75	15,5	12,30	5	009200510
12	24	75	15,5	14,10	5	009200512
14	24	75	15,5	14,10	5	009200514
17	24	75	15,5	14,10	5	009200517



920ME/SB7 € 99,00 📦 1 📄 009200519
5-6-8-10-12-14-17 mm



920ME/C7 € 113,50 📦 1 📄 009200518
5-6-8-10-12-14-17 mm
250X100X35 mm - 1,4 kg

920TX

chiavi a bussola maschio
per viti con impronta Torx®



Ø mm	L mm	L1 mm	€	📦	📄
T20	22,5	58	20	13,40	5 009200520
T20L	22,5	120	82	17,00	3 009200530
T25	22,5	58	20	13,40	5 009200521
T25L	22,5	120	82	17,00	3 009200531
T27	22,5	58	20	13,40	5 009200522
T27L	22,5	120	82	17,00	3 009200533
T30	22,5	58	20	13,40	5 009200523
T30L	22,5	120	82	17,00	3 009200534
T40	22,5	58	20	13,40	5 009200524
T40L	22,5	120	82	17,00	3 009200535
T45	22,5	58	20	13,40	5 009200525
T45L	22,5	120	82	17,00	3 009200537
T50	22,5	58	20	13,40	5 009200526
T50L	23,0	140	102	17,00	3 009200538
T55	23,0	58	20	17,90	3 009200527
T55L	23,0	140	102	24,00	3 009200539
T60	23,0	58	20	17,90	3 009200528
T60L	23,0	140	102	24,00	3 009200540
T70L	23,0	120	82	24,00	3 009200541



920TX/SB9 € 138,50 📦 1 📄 009200532
T20-T25-T27-T30
T40-T45-T50-T55-T60



920TX/L-SB4 € 73,50 📦 1 📄 009200542
T20L-T25L-T27L-T30L
920TX/L-SB6 130,00 📦 1 📄 009200543
T40L-T45L-T50L-
T55L-T60L-T70L



920TX/C9 € 148,50 📦 1 📄 009200546
T20-T25-T27-T30-T40
T45-T50-T55-T60
270X120X45 mm - 1,2 kg

920RTX

chiavi a bussola maschio per viti
con impronta Tamper Resistant Torx®

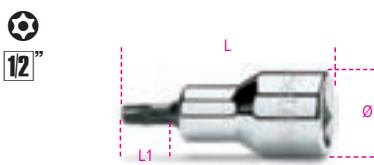

Ø mm	L mm	L1 mm	€	📦	📄
T20	22,5	58	20	14,50	5 009200370
T25	22,5	58	20	14,50	5 009200371
T27	22,5	58	20	14,50	5 009200372
T30	22,5	58	20	14,50	5 009200373
T40	22,5	58	20	14,50	5 009200374



920RTX/SB5 € 78,50 📦 1 📄 009200378
T20-T25-T27-T30-T40

920XZN

chiavi a bussola maschio
a profilo XZN®

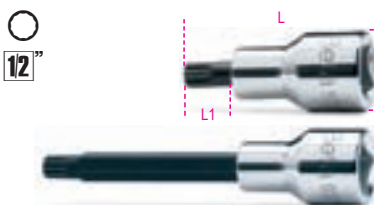

Ø mm	L mm	L1 mm	€	📦	📄
M4	22,5	58	20	14,00	5 009200559
M5	22,5	58	20	14,00	5 009200560
M6	22,5	58	20	14,00	5 009200561
M6L	22,5	100	62	16,00	3 009200562
M8	22,5	58	20	14,00	5 009200563
M8L	22,5	100	62	16,00	3 009200564
M9	22,5	58	20	14,00	3 009200582
M9L	22,5	100	62	16,00	3 009200583
M10	22,5	58	20	14,00	3 009200565
M10L	22,5	100	62	16,00	3 009200566
M12	22,5	58	20	14,00	3 009200568

Ø mm	L mm	L1 mm	€	📦	📄
M12L	22,5	100	62	16,00	3 009200569
M14	23,0	58	20	14,00	3 009200571
M14L	23,0	100	62	16,00	3 009200572
M16	23,0	58	20	18,00	3 009200573
M18	23,0	58	20	18,00	3 009200574



920XZN/SB7 € 105,50 📦 1 📄 009200579
M4-M5-M6-M8
M10-M12-M14



920XZN/SB12 € 193,50 📦 1 📄 009200577
M5-M6-M8-M10-M12
M14-M16-M6L-M8L
M10L-M12L-M14L



920XZN/LS5 € 80,00 📦 1 📄 009200578
M6L-M8L-M10L
M12L-M14L

920ES

chiavi a bussola per viti
con impronta esascalata



UNI 9326

Ø mm	🌀	L mm	L1 mm	€	📦	📄
7	(6R)	58	20	18,50	5	009200587
7XL	(6R)	240	202	26,50	1	009200607
9	(8R)	58	20	18,50	5	009200589
9XL	(8R)	240	202	26,50	1	009200609
10	(8S)	58	20	18,50	5	009200590
10XL	(8S)	240	202	26,50	1	009200610
11	(10R)	58	20	18,50	5	009200591
11XL	(10R)	240	202	26,50	1	009200611
12L	(10S)	100	62	20,50	3	009200592
12XL	(10S)	240	202	26,50	1	009200612
14L	(12S)	100	62	20,50	3	009200594
14XL	(12S)	240	202	26,50	1	009200614
16L	(14R)	100	62	20,50	3	009200596
16XL	(14R)	240	202	26,50	1	009200616



920ES/SB7 € 143,00 📦 1 📄 009200598
7-9-10-11-12L-14L-16L

920/46

quadro maschio 1/2"
con manovella

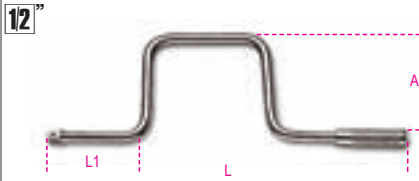

UNI/ISO 3315 DIN 3122

L	L1	A	€	3	009200862
mm	mm	mm			
385	110	160	23,50	1	009200862

920/50

cricchetto semplice
con attacco quadro scorrevole 1/2"
meccanismo a 72 denti



UNI/ISO 3315 DIN 3122

L	Ø	A	€	3	009200871
mm	mm	mm			
275	40	42	43,00	3	009200871

920/50F

cricchetto semplice
con attacco quadro femmina 1/2"
meccanismo a 72 denti



UNI/ISO 3315 DIN 3122

L	Ø	A	€	2	009200889
mm	mm	mm			
275	40	27	39,00	2	009200889

920/55

cricchetto reversibile
con attacco quadro maschio 1/2"
meccanismo a 72 denti



UNI/ISO 3315 DIN 3122

L	Ø	A	€	3	009200882
mm	mm	mm			
275	40	43	47,00	3	009200882

920/55Q

cricchetto reversibile
con attacco quadro maschio 1/2"
meccanismo a 48 denti



UNI/ISO 3315 DIN 3122

L	Ø	A	€	3	009200885
mm	mm	mm			
275	40	43	47,00	3	009200885

920/55X

cricchetto reversibile
con attacco quadro maschio 1/2"
meccanismo a 72 denti



UNI/ISO 3315 DIN 3122

L	Ø	A	€	3	009200895
mm	mm	mm			
200	30	33	40,00	3	009200895

920/55LC

cricchetto reversibile
con attacco quadro maschio 1/2"
"Locking System"
meccanismo a 72 denti



UNI/ISO 3315 DIN 3122

L	Ø	A	€	2	009200896
mm	mm	mm			
275	40	43	54,00	2	009200896

920M/55

cricchetto reversibile
con attacco quadro maschio 1/2"
con impugnatura in metallo



L	Ø	A	€	1	009200893
mm	mm	mm			
253	38	35	61,00	1	009200893

920/56A

cricchetto reversibile snodato
con attacco quadro maschio 1/2"
meccanismo a 72 denti



L	Ø	A	€	1	009200911
mm	mm	mm			
315	40	43	76,00	1	009200911

920M/56

cricchetto reversibile snodato
con attacco quadro maschio 1/2"
con impugnatura in metallo



L	Ø	A	€	2	009200894
mm	mm	mm			
330	38	35,7	81,00	2	009200894

920../C11

11 chiavi a bussola
e 2 accessori



920A/C11	€	1	009200921
	146,00	1	009200921

920A	10 - 12 - 13 - 14 - 15 - 16 17 - 18 - 19 - 21 - 22 mm
920/22	255 mm
920/50	
335x145x60 mm - 2,5 kg	

920B/C11	€	1	009200922
	146,00	1	009200922

920B	10 - 12 - 13 - 14 - 15 - 16 17 - 18 - 19 - 21 - 22 mm
920/22	255 mm
920/50	
335x145x60 mm - 2,5 kg	

920.../C12...

12 chiavi a bussola
e 5 accessori

12"



920A/C12X € 215,00 1 009200933

	○ 920A	10 - 11 - 12 - 13 - 14 - 17 - 19 22 - 24 - 27 - 30 - 32 mm
	920/21	125 mm
	920/22	255 mm
	920/25	
	920/42	
	920/55	

420x185x60 mm - 4,2 kg

920A/C12 € 211,00 1 009200931

	○ 920A	10 - 11 - 12 - 13 - 14 - 17 - 19 22 - 24 - 27 - 30 - 32 mm
	920/21	125 mm
	920/22	255 mm
	920/25	
	920/42	
	920/50	

420x185x60 mm - 4,2 kg

920B/C12X € 215,00 1 009200934

	○ 920B	10 - 11 - 12 - 13 - 14 - 17 - 19 22 - 24 - 27 - 30 - 32 mm
	920/21	125 mm
	920/22	255 mm
	920/25	
	920/42	
	920/55	

420x185x60 mm - 4,0 kg

920B/C12 € 211,00 1 009200932

	○ 920B	10 - 11 - 12 - 13 - 14 - 17 - 19 22 - 24 - 27 - 30 - 32 mm
	920/21	125 mm
	920/22	255 mm
	920/25	
	920/42	
	920/50	

420x185x60 mm - 4,0 kg

920.../C20...

20 chiavi a bussola
e 5 accessori

12"



920A/C20X € 272,00 1 009200950

	○ 920A	10 - 11 - 12 - 13 - 14 - 15 - 16 17 - 18 - 19 - 20 - 21 - 22 - 23 24 - 26 - 27 - 28 - 30 - 32 mm
	920/21	125 mm
	920/22	255 mm
	920/25	
	920/42	
	920/55	

420x185x60 mm - 5,1 kg

920A/C20 € 268,00 1 009200948

	○ 920A	10 - 11 - 12 - 13 - 14 - 15 - 16 17 - 18 - 19 - 20 - 21 - 22 - 23 24 - 26 - 27 - 28 - 30 - 32 mm
	920/21	125 mm
	920/22	255 mm
	920/25	
	920/42	
	920/50	

420x185x60 mm - 5,1 kg

920A/C20Q € 272,00 1 009200955

	○ 920A	10 - 11 - 12 - 13 - 14 - 15 - 16 17 - 18 - 19 - 20 - 21 - 22 - 23 24 - 26 - 27 - 28 - 30 - 32 mm
	920/21	125 mm
	920/22	255 mm
	920/25	
	920/42	
	920/55Q	

420x185x60 mm - 5,1 kg

920B/C20 € 268,00 1 009200949

	○ 920B	10 - 11 - 12 - 13 - 14 - 15 - 16 17 - 18 - 19 - 20 - 21 - 22 - 23 24 - 26 - 27 - 28 - 30 - 32 mm
	920/21	125 mm
	920/22	255 mm
	920/25	
	920/42	
	920/50	

420x185x60 mm - 5,0 kg

920.../C20...

20 chiavi a bussola
e 5 accessori

12"



920B/C20X € 272,00 1 009200951

	○ 920B	10 - 11 - 12 - 13 - 14 - 15 - 16 17 - 18 - 19 - 20 - 21 - 22 - 23 24 - 26 - 27 - 28 - 30 - 32 mm
	920/21	125 mm
	920/22	255 mm
	920/25	
	920/42	
	920/55	

420x185x60 mm - 5,0 kg

920.../C21...

21 chiavi a bussola
e 6 accessori

12"



920A/C21 € 309,00 1 009200952

	○ 920A	10 - 11 - 12 - 13 - 14 - 15 - 16 17 - 18 - 19 - 20 - 21 - 22 - 23 24 - 25 - 26 - 27 - 28 - 30 - 32 mm
	920/21	125 mm
	920/22	255 mm
	920/25	
	920/42	
	920/46	
	920/50	

420x280x60 mm - 6,5 kg

920A/C21X € 313,00 1 009200983

	○ 920A	10 - 11 - 12 - 13 - 14 - 15 - 16 17 - 18 - 19 - 20 - 21 - 22 - 23 24 - 25 - 26 - 27 - 28 - 30 - 32 mm
	920/21	125 mm
	920/22	255 mm
	920/25	
	920/42	
	920/46	
	920/55	

420x280x60 mm - 6,4 kg

920B/C21 € 309,00 1 009200953

- 920B 10 - 11 - 12 - 13 - 14 - 15 - 16
17 - 18 - 19 - 20 - 21 - 22 - 23
24 - 25 - 26 - 27 - 28 - 30 - 32 mm
- 920/21 125 mm
- 920/22 255 mm
- 920/25
- 920/42
- 920/46
- 920/50

420x280x60 mm - 6,4 kg

920B/C21X € 313,00 1 009200984

- 920B 10 - 11 - 12 - 13 - 14 - 15 - 16
17 - 18 - 19 - 20 - 21 - 22 - 23
24 - 25 - 26 - 27 - 28 - 30 - 32 mm
- 920/21 125 mm
- 920/22 255 mm
- 920/25
- 920/42
- 920/46
- 920/55

420x280x60 mm - 6,4 kg

920B/C30Q

30 chiavi a bussola poligonali e 5 accessori

12"



920B/C30Q € 451,00 1 009200975

- 920B 8 - 9 - 10 - 11 - 12 - 13 - 14
15 - 16 - 17 - 18 - 19 - 20 - 21
22 - 23 - 24 - 26 - 27 - 30 mm
- 920BL 12 - 13 - 14 - 17 - 19 - 21
22 - 24 - 27 - 30 mm
- 920/21 125 mm
- 920/22 255 mm
- 920/25
- 920/42
- 920/55Q

420x280x60 mm - 7,6 kg



920.../C33

20 chiavi a bussola
13 a giravite e 5 accessori

12"



920A/C33 € 436,00 1 009200985

- 920A 10 - 11 - 12 - 13 - 14 - 15 - 16
17 - 18 - 19 - 20 - 21 - 22 - 23
24 - 26 - 27 - 28 - 30 - 32 mm
- 920LP 1,2x8 - 1,6x9 - 2x12 mm
- 920PH PH2 - PH3 - PH4
- 920PE 4 - 5 - 6 - 8 - 10 - 12 - 14 mm
- 920/21 125 mm
- 920/22 255 mm
- 920/25
- 920/42
- 920/55

420x280x60 mm - 6,7 kg

920B/C33 € 436,00 1 009200986

- 920B 10 - 11 - 12 - 13 - 14 - 15 - 16
17 - 18 - 19 - 20 - 21 - 22 - 23
24 - 26 - 27 - 28 - 30 - 32 mm
- 920LP 1,2x8 - 1,6x9 - 2x12 mm
- 920PH PH2 - PH3 - PH4
- 920PE 4 - 5 - 6 - 8 - 10 - 12 - 14 mm
- 920/21 125 mm
- 920/22 255 mm
- 920/25
- 920/42
- 920/55

420x280x60 mm - 6,7 kg

920/C37

37 chiavi a bussola poligonali e 5 accessori

12"



920/C37 € 416,00 1 009200988

- 920B 10 - 11 - 12 - 13 - 14 - 15 - 16
17 - 18 - 19 - 20 - 21 - 22 - 23
24 - 26 - 27 - 28 - 30 - 32 mm
- 920AS 3/8 - 7/16 - 1/2 - 9/16 - 19/32
5/8 - 11/16 - 3/4 - 25/32 - 13/16
7/8 - 15/16 - 1 - 1.1/16 - 1.1/8
1.3/16 - 1.1/4
- 920/21 125 mm
- 920/22 255 mm
- 920/25
- 920/42
- 920/55

420x280x60 mm - 7,5 kg

920AS/C10

10 chiavi a bussola poligonali e 2 accessori

12"



920AS/C10 € 150,00 1 009200919

- 920AS 3/8 - 7/16 - 1/2 - 9/16 - 5/8
11/16 - 3/4 - 13/16 - 7/8 - 15/16
- 920/22 255 mm
- 920/50

335x145x60 mm - 2,6 kg

Beta

920AS/C15

15 chiavi a bussola poligonali
e 6 accessori

12"



920AS/C15 € 283,00 1 009200947

	920AS	3/8 - 7/16 - 1/2 - 9/16 - 5/8 - 11/16 3/4 - 13/16 - 7/8 - 15/16 - 1 1.1/16 - 1.1/8 - 1.3/16 - 1.1/4
	920/21	125 mm
	920/22	255 mm
	920/25	
	920/42	
	920/46	
	920/50	

420x280x60 mm - 5,9 kg

920AS/C17X

17 chiavi a bussola poligonali
e 5 accessori

12"



920AS/C17X € 268,00 1 009200942

	920AS	3/8 - 7/16 - 1/2 - 9/16 - 19/32 - 5/8 11/16 - 3/4 - 25/32 - 13/16 - 7/8 15/16 - 1 - 1.1/16 - 1.1/8 - 1.3/16 - 1.1/4
	920/21	125 mm
	920/22	255 mm
	920/25	
	920/42	
	920/55	

420x185x60 mm - 4,8 kg

920AS/MBM-C21

16 chiavi a bussola poligonali
e 5 accessori
per manutenzioni aeronautiche

12"



920AS/MBM-C21 € 273,00 1 009200944

	920AS	3/8 - 7/16 - 1/2 - 9/16 19/32 - 5/8 - 11/16 - 3/4 25/32 - 13/16 - 7/8 - 15/16 1 - 1.1/16 - 1.3/16 - 1.1/4
	920M/55	
	920/21	125 mm
	920/22	255 mm
	920/25	
	920/42	

420x185x60 mm - 5,0 kg

920TX/C17

6 inserti per avvitatori
6 chiavi a bussola
5 chiavi a bussola maschio
e 4 accessori, per viti con impronta Torx®

12"

12"



920TX/C17 € 238,50 1 009200989

	861TX	T8 - T10 - T15 - T20 - T25 - T27
	897	
	920TX	T27 - T30 - T40 - T45 - T50
	920FTX	E10 - E12 - E14 - E16 - E18 - E20
	920/20	75 mm
	920/22	255 mm
	920/55	

420x185x60 mm - 2,9 kg

928A

chiavi a bussola a mano
bocca esagonale

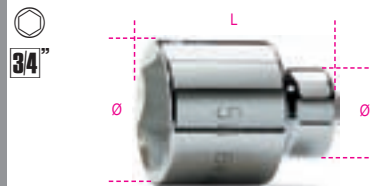

UNI/ISO 3316
DIN 3123

Ø mm	Ø mm	L mm	Ø1 mm	€		
19	29,2	50	34	13,30	5	009280019
22	31,3	53	34	13,30	5	009280022
23	33,3	53	34	13,30	5	009280023
24	34,5	53	34	13,30	5	009280024
26	36,8	55	35	14,60	5	009280026
27	38,0	56	35	14,60	5	009280027
28	39,0	57	35	15,20	5	009280028
29	40,2	58	35	15,20	5	009280029
30	41,5	58	37	15,20	5	009280030
32	44,3	60	37	16,60	5	009280032
33	45,8	60	37	17,10	3	009280033
34	46,8	60	37	17,10	3	009280034
35	48,1	62	38	17,80	3	009280035
36	49,5	64	38	17,80	3	009280036
38	52,0	68	40	19,50	3	009280038
41	56,0	71	40	21,50	3	009280041
46	62,3	75	43	27,50	3	009280046
50	67,4	80	43	33,00	3	009280050
55	73,7	84	48	42,00	1	009280055
60	80,0	87	48	46,50	1	009280060

928B

chiavi a bussola a mano
bocca poligonale

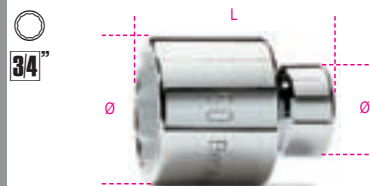

UNI/ISO 3316
DIN 3123

Ø mm	Ø mm	L mm	Ø1 mm	€		
19	29,2	50	34	13,30	5	009280119
22	31,3	53	34	13,30	5	009280122
23	33,3	53	34	13,30	5	009280123
24	34,5	53	34	13,30	5	009280124
26	36,8	55	35	14,60	5	009280126
27	38,0	56	35	14,60	5	009280127
28	39,0	57	35	15,20	5	009280128
29	40,2	58	35	15,20	5	009280129
30	41,5	58	37	15,20	5	009280130
32	44,3	60	37	16,60	5	009280132
33	45,8	60	37	17,10	3	009280133
34	46,8	60	37	17,10	3	009280134
35	48,1	62	38	17,80	3	009280135
36	49,5	64	38	17,80	3	009280136
38	52,0	68	40	19,50	3	009280138
41	56,0	71	40	21,50	3	009280141
46	62,3	75	43	27,50	3	009280146
50	67,4	80	43	33,00	3	009280150
55	73,7	84	48	42,00	1	009280155
60	80,0	87	48	46,50	1	009280160

Beta
EST. 1962

928AS

chiavi a bussola a mano
bocca esagonale

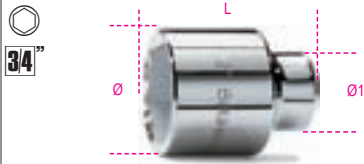

"	Ø mm	L mm	Ø1 mm	€		
7/8	32,0	53	34	14,60	1	009280202
15/16	34,5	53	34	14,60	1	009280203
1	36,2	55	35	15,80	1	009280204
1.1/16	38,0	56	35	15,80	1	009280205
1.1/8	40,2	58	35	16,40	1	009280206
1.1/4	44,2	60	37	17,80	1	009280208
1.5/16	45,8	60	37	18,30	1	009280209
1.3/8	48,1	62	38	19,00	1	009280210
1.7/16	49,5	64	38	19,00	1	009280211
1.1/2	52,0	68	40	21,50	1	009280212
1.5/8	56,0	71	40	23,00	1	009280214
1.11/16	58,8	74	40	26,50	1	009280215
1.13/16	62,3	75	43	30,50	1	009280217
1.7/8	65,0	78	43	30,50	1	009280218
2	68,3	80	43	38,00	1	009280219
2.1/16	71,5	83	48	45,50	1	009280220

928ME

chiavi a bussola
maschio esagonale

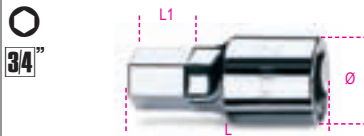

mm	Ø mm	L mm	L1 mm	€		
14	35	75	15,5	27,00	2	009280514
17	35	75	15,5	27,00	2	009280517
19	35	75	15,5	27,00	2	009280519
22	35	75	22,5	27,00	2	009280522

928/15

raccordo con attacco quadro
femmina 3/4" e maschio 1/2"



UNI/ISO 3316
DIN 3123

L mm	Ø mm	3/4"	1/2"	€		
51,5	34	3/4	1/2	14,00	5	009280801

! E' assolutamente necessario commisurare la coppia di serraggio alla capacità del quadro maschio per evitare rotture o danni accidentali

928/16

raccordo con attacco quadro
femmina 3/4" e maschio 1"



UNI/ISO 3316
DIN 3123

L mm	Ø mm	3/4"	1"	€		
65	34	3/4	1"	17,50	5	009280807

928/21 - 928/22

prolunghe con attacchi quadri
maschio e femmina 3/4"

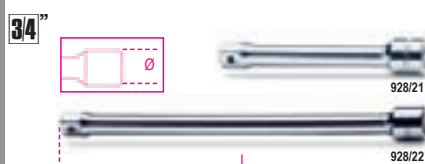

UNI/ISO 3316
DIN 3123

	L mm	Ø mm	€		
928/21	200	34	24,00	3	009280815
928/22	380	34	34,00	3	009280825

928/25

snodo con attacchi quadri maschio
e femmina 3/4"



UNI/ISO 3316 DIN 3123

L mm	Ø mm	€		
108	40	63,00	1	009280830

928/36A

quadro maschio 3/4" snodato
con impugnatura



L mm	€		
545	70,00	1	009280844

928/42

quadro maschio 3/4"
con spina scorrevole

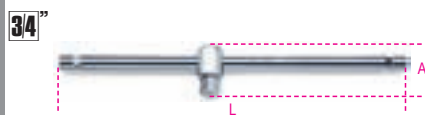

UNI/ISO 3315 DIN 3122

L mm	A mm	€		
450	62,5	36,00	3	009280850

928/55

cricchetto reversibile
con attacco quadro maschio 3/4"
meccanismo a 72 denti



L mm	Ø mm	A mm	€		
510	58	59	115,00	2	009280862

928.../C12

12 chiavi a bussola esagonali e 5 accessori in
cassetta di lamiera



928A/C12 € 602,00 1 009280955

	928A	22 - 24 - 27 - 30 - 32 - 34 - 36 38 - 41 - 46 - 50 - 55 mm
	928/21	200 mm
	928/22	380 mm
	928/25	
	928/42	
	928/55	

530x220x80 mm - 13,5 kg

928B/C12 € 602,00 1 009280957

	928B	22 - 24 - 27 - 30 - 32 - 34 - 36 38 - 41 - 46 - 50 - 55 mm
	928/21	200 mm
	928/22	380 mm
	928/25	
	928/42	
	928/55	

530x220x80 mm - 13,5 kg

928AS/C12

12 chiavi a bussola esagonali e 5 accessori in
cassetta di lamiera



928AS/C12 € 622,00 1 009280968

	928AS	7/8-15/16-1.1/16-1.1/8-1.1/4 1.5/16-1.7/16-1.1/2-1.11/16 1.13/16-1.7/8-2.1/16
	928/21	200 mm
	928/22	380 mm
	928/25	
	928/42	
	928/55	

530x220x80 mm - 13,5 kg

929

chiavi a bussola a mano
bocca esagonale

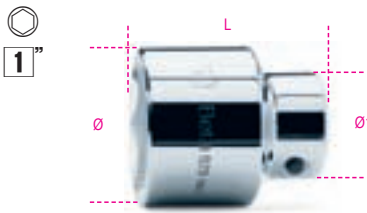

UNI/ISO 2725 DIN 3124

Ø mm	Ø mm	L mm	Ø1 mm	€		
36	49,5	65	48	34,00	1	009290036
41	56,0	70	48	35,00	1	009290041
46	62,0	75	48	36,00	1	009290046
50	67,5	80	48	43,00	1	009290050
55	74,0	85	54	47,00	1	009290055
60	80,0	90	54	55,00	1	009290060
65	86,0	95	54	60,00	1	009290065
70	92,0	100	60	70,00	1	009290070
75	99,0	110	60	77,00	1	009290075
80	106,0	120	60	86,00	1	009290080

929/15

raccordo con attacco quadro
femmina 1" e maschio 3/4"

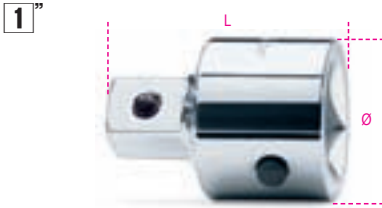

UNI/ISO 3316 DIN 3123

L mm	Ø mm	□ 1"	■ 3/4"	€		
65	47	1"	3/4"	29,00	2	009290801



E' assolutamente necessario commisurare la coppia di serraggio alla capacità del quadro maschio per evitare rotture o danni accidentali

929/21 - 929/22

prolunghe con attacchi quadri
maschio e femmina 1"

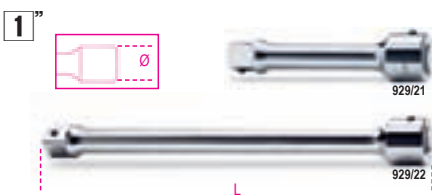

UNI/ISO 3316 DIN 3123

	L mm	Ø mm	€		
929/21	200	47	41,00	1	009290815
929/22	400	47	57,00	1	009290825

929/42

quadro maschio 1"
con spina scorrevole



UNI/ISO 3315 DIN 3122

L mm	€		
535	72,00	1	009290850

929/55

cricchetto reversibile
con attacco quadro maschio 1"
meccanismo a 72 denti



UNI/ISO 3315 DIN 3122

L mm	Ø mm	A mm	€		
770	62	63	158,00	1	009290860

929/C8

8 chiavi a bussola esagonali
e 5 accessori



929/C8	€		
	981,00	1	009290925

○ 929	46 - 50 - 55 - 60 - 65
	70 - 75 - 80 mm
□ 1" - ■ 3/4"	
929/15	
929/21	200 mm
929/22	400 mm
929/42	
929/55	

560x290x12 mm - 29 kg

900/R55



900/R55	€		
900/55	26,50	1	009000871

900M/R55



900M/R55	€		
900M/55	12,00	1	009000888

910/R55



910/R55	€		
606/6-606/10-612	26,50	1	009100879
666/6-666/10-910/55			
599DGT/6			

910M/R55



910M/R55	€		
910M/55-910M/56	13,00	1	009100888

910/R55Q



910/R55Q	€		
910/55Q	26,50	1	009100877

920/R50



920/R50	€		
614/50-667/20-667/30	25,00	1	009200866
920/50			

920/R55



920/R55	€		
606/20-606/30-666/20-666/30	31,00	1	009200879
920/55-920/56A- 599DGT/20-599DGT/30			

920M/R55



920M/R55	€		
920M/55-920M/56	14,50	1	009200888

920/R55Q



920/R55Q	€		
920/55Q	31,00	1	009200877

Beta

920/R55X

12
72



920/R55X
606/10X-612X
666/10X-920/55X-599DGT/10X

€ 26,00 1 009200878

920/R55LC

12
72



920/R55LC
920/55LC "Locking System"

€ 35,00 1 009200887

928/R55

34
72



928/R55
928/55

€ 47,00 1 009280859

928/R55X

34
72



928/R55X
614X

€ 32,00 1 009280858

929/R55

1
72



929/R55
929/55

€ 58,00 1 009290859

930

chiavi a tubo doppie poligonali
serie pesante



UNI 6745

Ø mm	L mm	Ø mm	Ø1 mm	€		
6x7	100	9,5	11,0	10,20	3	009300006
8x9	108	12,5	14,0	11,50	3	009300010
10x11	116	15,0	16,5	12,00	3	009300014
12x13	124	17,5	19,0	14,40	3	009300018
14x15	132	20,0	21,5	15,90	3	009300023
16x17	140	23,0	24,0	18,00	3	009300027
18x19	148	25,0	26,5	20,00	3	009300032
20x22	156	28,0	30,0	22,50	2	009300036
21x23	163	29,0	31,5	24,00	2	009300040
24x26	173	33,0	35,5	29,50	2	009300044
25x28	182	34,5	38,0	33,00	2	009300048
27x29	191	37,0	39,5	38,00	2	009300052
30x32	200	40,5	43,0	46,00	2	009300056



930/S8
6x7-8x9-10x11
12x13-14x15-16x17
18x19-20x22 mm

€ 133,50 1 009300081

930/S12
6x7-8x9-10x11-12x13
14x15-16x17-18x19
20x22-21x23-24x26
25x28-30x32 mm

€ 276,00 1 009300082

930/S13
6x7-8x9-10x11-12x13
14x15-16x17-18x19
20x22-21x23-24x26
25x28-27x29-30x32 mm

€ 314,00 1 009300083



930/SP13
6x7-8x9-10x11-12x13
14x15-16x17-18x19
20x22-21x23-24x26
25x28-27x29-30x32 mm

€ 334,00 1 009300084

930/SPV
€ 20,00 1 009300095



930/C13
6x7-8x9-10x11-12x13
14x15-16x17-18x19
20x22-21x23-24x26
25x28-27x29-30x32 mm

€ 347,00 1 009300098

932

chiavi a pipa doppie
esagonali-poligonali
cromate lucide

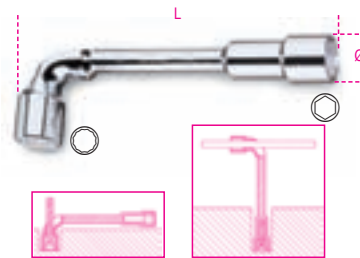

NF E 74.303

Ø mm	Ø mm	L mm	€		
6x6	11,5	110	11,40	5	009320006
7x7	12,5	116	11,50	5	009320007
8x8	13,0	120	12,10	5	009320008
9x9	14,0	125	12,40	5	009320009
10x10	16,5	133	13,00	5	009320010
11x11	17,5	143	14,20	5	009320011
12x12	19,0	148	15,20	5	009320012
13x13	19,5	154	15,60	5	009320013
14x14	21,5	167	16,40	5	009320014
15x15	22,5	182	17,30	5	009320015
16x16	24,5	193	17,90	5	009320016
17x17	26,0	198	18,00	5	009320017
18x18	26,5	215	19,90	5	009320018
19x19	29,0	220	22,00	5	009320019
20x20	30,5	222	23,00	3	009320020
21x21	30,5	236	27,00	3	009320021
22x22	32,5	250	29,00	2	009320022
23x23	33,5	256	32,50	2	009320023
24x24	35,0	272	34,50	2	009320024
25x25	36,5	282	35,50	2	009320025
26x26	37,5	296	40,50	2	009320026
27x27	39,0	296	43,50	2	009320027
28x28	39,0	314	47,50	2	009320028
30x30	42,5	348	57,00	2	009320030
32x32	45,5	364	64,50	2	009320032



932/S11
6-7-8-10-11-12
13-14-17-19-22 mm

€ 178,50 1 009320080

932/S17
6-7-8-9-10-11-12
13-14-15-16-17
18-19-20-21-22 mm

€ 296,00 1 009320081

932/S25
6-7-8-9-10-11-12-13
14-15-16-17-18-19
20-21-22-23-24-25
26-27-28-30-32 mm

€ 651,00 1 009320082



933

chiavi a pipa doppie
esagonali
cromate lucide

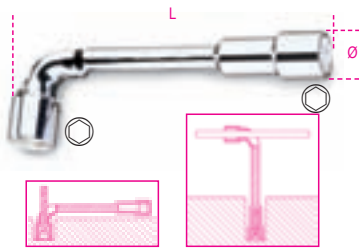

NF E 74.303

Ø mm	Ø mm	L mm	€		
6x6	11,5	110	11,40	5	009330006
7x7	12,5	116	11,50	5	009330007
8x8	13,0	120	12,10	5	009330008
9x9	14,0	125	12,40	5	009330009
10x10	16,5	133	13,00	5	009330010
11x11	17,5	143	14,20	5	009330011
12x12	19,0	148	15,20	5	009330012
13x13	19,5	154	15,60	5	009330013
14x14	21,5	167	16,40	5	009330014
15x15	22,5	182	17,30	5	009330015
16x16	24,5	193	17,90	5	009330016
17x17	26,0	198	18,00	5	009330017
18x18	26,5	215	19,90	5	009330018
19x19	29,0	220	22,00	5	009330019
20x20	30,5	222	23,00	3	009330020
21x21	30,5	236	27,00	3	009330021
22x22	32,5	250	29,00	2	009330022
23x23	33,5	256	32,50	2	009330023
24x24	35,0	272	34,50	2	009330024
25x25	36,5	282	35,50	2	009330025
26x26	37,5	296	40,50	2	009330026
27x27	39,0	296	43,50	2	009330027
28x28	39,0	314	47,50	2	009330028
30x30	42,5	348	57,00	2	009330030
32x32	45,5	364	64,50	2	009330032



933/S11	€		
6-7-8-10-11-12 13-14-17-19-22 mm	178,50	1	009330080
933/S17	296,00	1	009330081
6-7-8-9-10-11-12 13-14-15-16-17 18-19-20-21-22 mm	651,00	1	009330082
933/S25			
6-7-8-9-10-11-12-13 14-15-16-17-18-19 20-21-22-23-24-25 26-27-28-30-32 mm			

935

chiavi a tubo doppie
esagonali
serie leggera



UNI 6746 DIN 896

Ø mm	L mm	€		
6x7	100	6,00	5	009350105
8x9	110	6,30	5	009350111
10x11	120	6,60	5	009350115
12x13	130	7,20	5	009350117
14x15	140	8,50	5	009350126
16x17	150	9,30	5	009350128
18x19	160	10,50	5	009350131
20x22	170	13,50	3	009350138
21x23	180	15,00	3	009350141
24x26	190	17,00	3	009350144
25x28	200	18,50	2	009350150
27x29	210	22,30	2	009350153
30x32	220	24,00	2	009350156

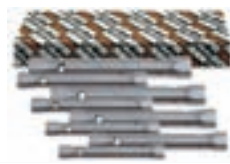

935/S8	€		
6x7-8x9-10x11 12x13-14x15-16x17 18x19-20x22 mm	77,00	1	009350181
935/S12	161,00	1	009350182
6x7-8x9-10x11 12x13-14x15-16x17 18x19-20x22-21x23 24x26-25x28-30x32 mm			
935/S13	183,50	1	009350183
6x7-8x9-10x11 12x13-14x15-16x17 18x19-20x22-21x23 24x26-25x28-27x29 30x32 mm			

937

chiavi a pipa doppie
esagonali-poligonali
cromate

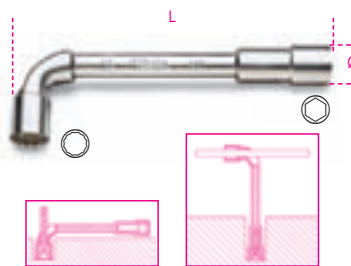

Ø mm	Ø mm	L mm	€		
6x6	11,5	110	5,70	5	009370006
7x7	12,5	116	6,00	5	009370007
8x8	13,0	120	6,30	5	009370008
9x9	14,0	125	6,80	5	009370009
10x10	16,5	133	6,90	5	009370010
11x11	17,5	143	7,30	5	009370011
12x12	19,0	148	8,20	5	009370012
13x13	19,5	154	8,40	5	009370013
14x14	21,5	167	9,20	5	009370014
15x15	22,5	182	10,30	5	009370015
16x16	24,5	193	11,20	5	009370016
17x17	26,0	198	11,50	5	009370017
18x18	26,5	215	11,70	5	009370018
19x19	29,0	220	12,50	5	009370019
20x20	30,5	222	13,60	3	009370020
21x21	30,5	236	15,00	3	009370021
22x22	32,5	250	16,20	2	009370022
23x23	33,5	256	17,00	2	009370023
24x24	35,0	272	18,80	2	009370024
25x25	36,5	282	23,00	2	009370025
26x26	37,5	296	24,00	2	009370026
27x27	39,0	296	25,00	2	009370027
28x28	39,0	314	28,00	2	009370028
30x30	42,5	348	31,00	2	009370030
32x32	45,5	364	34,00	2	009370032



937/S11	€		
6-7-8-10-11-12 13-14-17-19-22 mm	98,00	1	009370080
937/S17	167,00	1	009370081
6-7-8-9-10-11-12 13-14-15-16-17 18-19-20-21-22 mm			

940

spine di manovra per 930-935



	Ø mm	L mm	€		
940/1	6÷13	100	4,10	5	009400001
940/2	14÷22	170	4,90	5	009400002
940/3	21÷32	290	9,70	5	009400003

941

chiavi a pipa esagonali-poligonali
con impugnatura di manovra

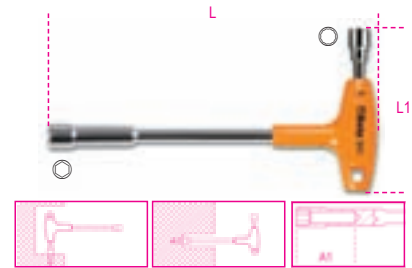

Ø mm	L mm	L1 mm	A1 mm	€		
7x7	200	91	35	18,50	2	009410107
8x8	220	107	50	19,50	2	009410108
9x9	220	109	50	19,50	2	009410109
10x10	236	111	50	20,00	2	009410110
11x11	236	114	50	20,00	2	009410111
12x12	255	122	50	21,50	2	009410112
13x13	255	124	55	21,50	2	009410113



941/S7	€		
7-8-9-10-11-12-13 mm	140,50	1	009410170

942BX

chiavi a bussola esagonale
tipo corto



UNI 6750

Ø mm	L mm	L1 mm	A1 mm	€		
4	190	70	3,0	10,00	5	009420003
5	190	70	3,5	10,00	5	009420004
5,5	190	70	4,0	11,00	5	009420005
6	190	70	5,0	11,00	5	009420006
7	190	70	6,0	12,00	5	009420007
8	202	70	7,0	12,00	5	009420008
9	202	70	8,0	12,00	5	009420009
10	202	70	8,5	12,50	3	009420010
11	202	70	9,0	12,50	3	009420011
12	202	70	9,5	12,50	3	009420012
13	202	70	10,5	14,00	3	009420013
14	202	70	11,5	14,00	3	009420014



942BX/S12 € 143,50 1 009420030
4-5-5,5-6-7-8-9
10-11-12-13-14 mm

943BX

chiavi a bussola esagonale
tipo lungo



ISO 2236 UNI 6750

mm	L mm	L1 mm	A1 mm	€		
4	270	150	3,0	11,00	5	009430003
5	270	150	3,5	11,00	5	009430004
5,5	270	150	4,0	12,00	5	009430005
6	270	150	5,0	12,00	5	009430006
7	270	150	6,0	13,00	5	009430007
8	282	150	7,0	13,00	5	009430008
9	282	150	8,0	13,00	5	009430009
10	282	150	8,5	13,50	3	009430010
11	282	150	9,0	13,50	3	009430011
12	282	150	9,5	13,50	3	009430012
13	282	150	10,5	15,00	3	009430013
14	282	150	11,5	15,00	3	009430014



943BX/S12 € 155,50 1 009430030
4-5-5,5-6-7-8-9
10-11-12-13-14 mm



943BX/D6 € 77,50 1 009430026
5-6-7-8-10-13 mm

943FL

chiavi a bussola esagonale flessibili
con impugnatura



mm	L mm	L1 mm	Ø mm	€		
5	265	150	8	15,60	2	009430304
5,5	265	150	8	15,60	2	009430305
6	265	150	9	15,60	2	009430306
7	265	150	11	15,60	2	009430307
8	265	150	12	16,20	2	009430308
10	290	175	14	16,90	2	009430310



943FL/S6 € 95,50 1 009430320
5-5,5-6-7-8-10 mm

944BX

chiavi a bussola esagonale profonda
tipo lungo



ISO 2236 UNI 6750

mm	L mm	L1 mm	A1 mm	€		
4	245	125	20	12,00	3	009440003
5	245	125	25	12,00	3	009440004
5,5	245	125	30	14,50	3	009440005
6	245	125	35	14,50	3	009440006
7	245	125	35	14,50	3	009440007
8	257	125	50	15,50	3	009440008
9	257	125	50	15,50	3	009440009
10	257	125	50	16,00	3	009440010
11	257	125	50	16,00	3	009440011
12	257	125	50	17,50	3	009440012
13	257	125	55	17,50	3	009440013
14	257	125	55	17,50	3	009440014



944BX/S12 € 183,00 1 009440062
4-5-5,5-6-7-8-9
10-11-12-13-14 mm



944BX/D6 € 90,00 1 009440056
5-6-7-8-10-13 mm

950

chiavi a T semplici
esagonali

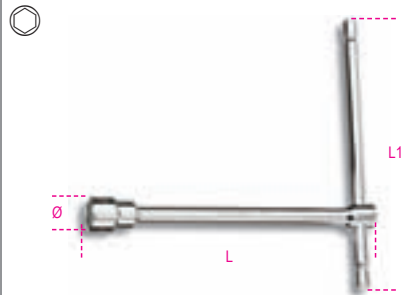

UNI 6742 DIN 3112

mm	L mm	Ø mm	L1 mm	€		
6	210	10,1	145	14,50	3	009500006
7	212	11,2	145	14,50	3	009500007
8	220	12,4	160	15,50	3	009500008
9	223	13,5	160	15,50	3	009500009
10	230	14,9	160	16,50	3	009500010
11	233	16,1	160	16,50	3	009500011
12	240	17,5	175	18,50	3	009500012
13	244	19,7	175	19,00	3	009500013
14	250	20,1	190	20,00	3	009500014
15	254	21,5	190	22,00	3	009500015
16	260	22,7	200	24,00	3	009500016
17	264	24,1	200	25,00	3	009500017
19	274	26,6	230	29,00	3	009500019
22	290	29,9	290	35,00	2	009500022
24	300	32,2	320	39,50	2	009500024
27	315	36,2	370	47,00	2	009500027



950/S9 € 174,50 1 009500079
7-8-10-11-12
13-14-17-19 mm

950/S14 € 285,00 1 009500082
6-7-8-9-10-11-12-13
14-15-16-17-19-22 mm





951

chiavi a T con tre estremità maschio esagonale



mm	L mm	L1 mm	Ø mm	€		
2	125	63	4,0	13,70	5	009510521
2,5	150	63	4,0	13,70	5	009510525
3	150	63	4,0	13,70	5	009510530
3,5	175	76	5,5	14,20	5	009510535
4	175	76	5,5	14,20	5	009510540
4,5	195	87	6,5	15,50	5	009510545
5	195	87	6,5	15,50	5	009510550
6	215	99	8,0	17,50	5	009510560
7	230	109	9,0	18,50	5	009510570
8	250	122	10,0	18,50	5	009510580
9	265	132	11,0	23,50	5	009510590
10	280	142	12,0	23,50	5	009510610
12	305	160	15,0	31,00	3	009510620
14	330	178	17,0	38,50	3	009510640

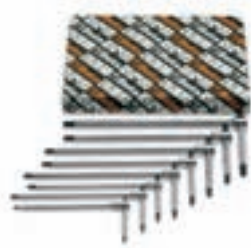

951/S8	118,00	1	009510693
2-2,5-3-3,5-4-4,5-5-6 mm			
951/S14	271,00	1	009510695
2-2,5-3-3,5-4-4,5-5-6-7-8-9-10-12-14 mm			



951/SP6	120,00	1	009510696
3-4-5-6-8-10 mm			
951/SPV	19,00	1	009510697

951AS

chiavi a T con tre estremità maschio esagonale



"	L mm	L1 mm	Ø mm	€		
3/32	125	63	4,0	18,00	2	009510750
7/64	150	63	4,0	18,00	2	009510751
1/8	150	63	4,0	18,00	2	009510752
9/64	175	76	5,5	19,00	2	009510753
5/32	175	76	5,5	19,00	2	009510754
3/16	195	86	6,5	20,50	2	009510755
7/32	215	99	8,0	20,50	2	009510757
1/4	230	109	9,0	22,00	2	009510758
5/16	250	122	10,0	23,50	2	009510759
3/8	280	142	12,0	28,00	2	009510760

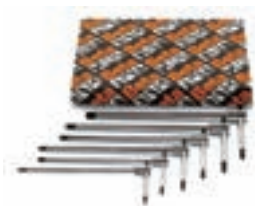

951AS/S6	133,50	1	009510770
5/32-3/16-7/32			
1/4-5/16-3/8			

951TX

chiavi a T con tre estremità maschio per viti con impronta Torx®



⊕	L mm	L1 mm	Ø mm	€		
T6	125	63	4	16,50	3	009510806
T7	125	63	4	16,50	3	009510807
T8	125	63	4	17,00	3	009510808
T9	125	63	4	17,00	3	009510809
T10	150	63	4	17,50	3	009510810
T15	150	63	4	17,50	3	009510815
T20	175	76	5	18,50	3	009510820
T25	175	76	5	18,50	3	009510825
T27	195	87	6	20,00	3	009510827
T30	195	87	6	20,00	3	009510830
T40	215	99	7	22,00	3	009510840
T45	230	109	8	23,00	3	009510845
T50	250	122	9	25,00	3	009510850

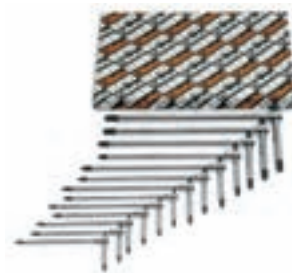

951TX/S13	249,00	1	009510863
T6-T7-T8-T9-T10-T15-T20-T25			
T27-T30-T40-T45-T50			

952

chiavi a T con bussola esagonale snodata

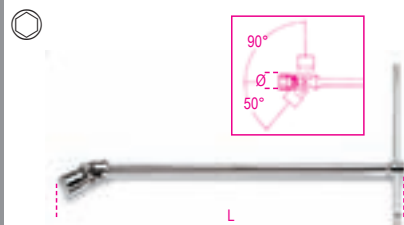

UNI 6743

⊕	Ø mm	L mm	€		
6	9,5	395	22,50	5	009520006
7	10,7	395	22,50	5	009520007
8	12,1	395	22,50	5	009520008
9	13,2	395	22,50	5	009520009
10	14,6	400	24,50	5	009520010
11	15,8	400	24,50	5	009520011
12	17,0	400	24,50	5	009520012
13	18,7	432	26,00	5	009520013
14	19,7	432	26,00	5	009520014
15	20,9	450	31,50	3	009520015
16	22,0	450	31,50	3	009520016
17	23,4	450	31,50	3	009520017
18	24,7	450	31,50	3	009520018
19	26,0	500	39,50	3	009520019
20	27,4	500	39,50	3	009520020
21	28,5	500	39,50	3	009520021
22	29,7	500	39,50	3	009520022
24	32,4	500	39,50	3	009520024



952/S7	194,50	1	009520074
8-10-11-13-14-17-19 mm			
952/S18	539,00	1	009520083
6-7-8-9-10-11-12			
13-14-15-16-17			
18-19-20-21-22-24 mm			

952AS

chiavi a T con bussola esagonale snodata

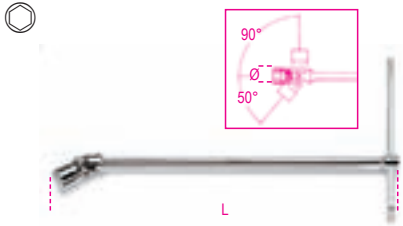

mm -"	Ø mm	L mm	€	Icon	Icon
1/4	9,5	395	25,00	2	009520256
5/16	12,1	395	25,00	2	009520258
3/8	14,6	400	27,00	2	009520260
7/16	15,8	400	27,00	2	009520261
1/2	18,7	432	29,00	2	009520263
9/16	19,7	432	29,00	2	009520264
5/8	22,0	450	35,00	2	009520266
11/16	23,4	450	35,00	2	009520267
3/4	26,0	500	44,00	2	009520269

952L

chiavi a T con bussola esagonale snodata, tipo lungo

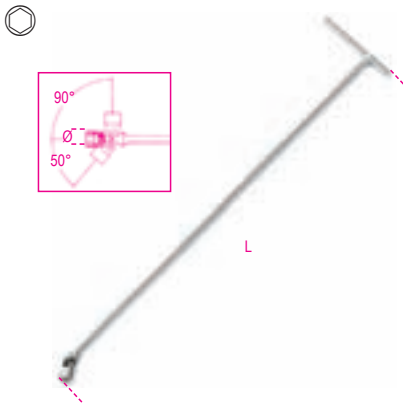

mm	Ø mm	L mm	€	Icon	Icon
10	14,6	930	60,00	1	009520410
12	17,0	1063	60,00	1	009520412
13	18,7	1100	60,00	1	009520413
14	19,7	1100	60,00	1	009520414
15	20,9	1100	67,00	1	009520415
16	22,0	1100	67,00	1	009520416
17	23,4	1100	67,00	1	009520417
18	24,7	1100	67,00	1	009520418
19	26,0	1100	81,00	1	009520419

952FTX

chiavi a T con bussola snodata per viti con testa a profilo Torx®

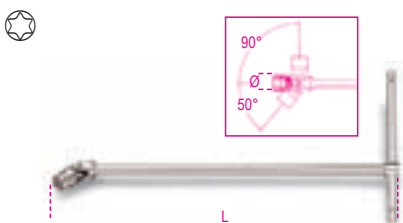

mm	Ø mm	L mm	€	Icon	Icon
E6	8	392	26,50	2	009520106
E7	9	392	26,50	2	009520107
E8	10	395	29,00	2	009520108
E10	13	400	30,50	2	009520110
E12	15	440	37,50	2	009520112
E14	17	490	46,00	2	009520114
E16	19	490	46,00	2	009520116
E18	21	490	46,00	2	009520118
E20	23	490	46,00	2	009520120



952FTX/S9
E6-E7-E8-E10-E12
E14-E16-E18-E20
€ 334,00 1 009520141

953

chiavi a T con maschio esagonale snodato

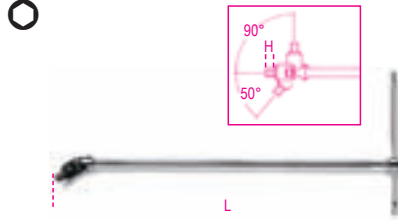

UNI 6754

mm	H mm	L mm	€	Icon	Icon
3	5	395	23,50	5	009530130
3,5	6	395	23,50	5	009530135
4	6	395	23,50	5	009530140
4,5	7	395	23,50	5	009530145
5	7	395	23,50	5	009530150
6	9	400	23,50	5	009530160
7	10	425	26,00	5	009530170
8	11	425	26,00	5	009530180
10	13	440	32,00	5	009530200



953/S9
3-3,5-4-4,5
5-6-7-8-10 mm
€ 225,00 1 009530301

953TX

chiavi a T con maschio snodato per viti con impronta Torx®

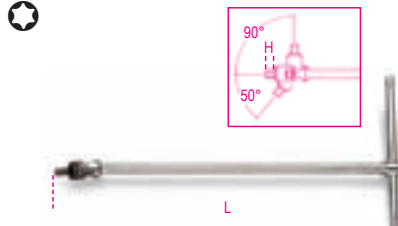

mm	H mm	L mm	€	Icon	Icon
T20	11	396	29,00	2	009530020
T25	11	396	29,00	2	009530025
T27	11	396	29,00	2	009530027
T30	13	400	31,00	2	009530030
T40	13	400	31,00	2	009530040
T45	13	426	33,00	2	009530045
T50	14	442	38,00	2	009530050
T55	14	442	39,00	2	009530055



953TX/S8
T20-T25-T27-T30
T40-T45-T50-T55
€ 259,00 1 009530060

955

chiave a tubo semplice per candele d'accensione

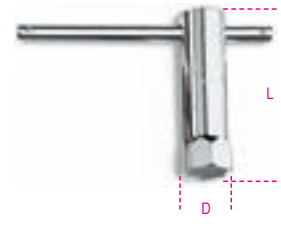

mm -"	D mm	L mm	€	Icon	Icon
16	21	86	11,50	3	009550016
5/8	20,8	86	11,50	3	009550021
13/16					

956C

chiavi a bussola con attacco quadro femmina 1/2" per candele d'accensione

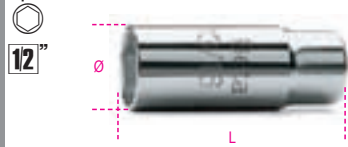

ISO 11168

mm -"	Ø mm	L mm	€	Icon	Icon	
14	18,8	70	21,00	5	009560008	
9/16	21,4	70	21,00	5	009560010	
5/8	17,8	23,6	70	21,00	5	009560011
11/16	20,8	27,0	70	21,00	5	009560012
13/16						

956E

chiavi a bussola con attacco quadro femmina 3/8" per candele d'accensione



ISO 11168

mm -"	Ø mm	L mm	€	Icon	Icon	
14	18,8	70	23,00	5	009560018	
9/16	21,4	70	23,00	5	009560020	
5/8	17,8	23,6	70	23,00	5	009560021
11/16	20,8	27,0	70	23,00	5	009560022
13/16						

956L

chiavi a bussola poligonale con attacco quadro femmina 1/2" tipo lungo, per candele d'accensione



mm -"	Ø mm	L mm	€	Icon	Icon	
14	20,2	250	46,00	2	009560214	
9/16	24,0	250	46,00	2	009560216	
5/8	17,8	24,0	250	49,00	2	009560217
11/16	20,8	28,5	250	49,00	2	009560221
13/16						

957

chiavi a T con bussola snodata per candele d'accensione

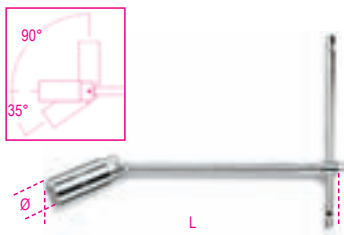

ISO 11168

mm -"	ø mm	L mm	€	3	009570000
16 5/8	21,4	275	32,00	3	009570000
20,8 13/16	27,0	275	38,00	3	009570001

959

chiavi a T con bussola snodata tipo normale, per candele d'accensione

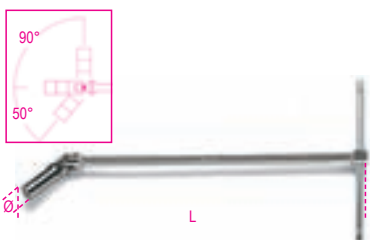

ISO 11168

mm -"	ø mm	L mm	€	3	009590009
14 9/16	18,8	483	39,00	3	009590009
16 5/8	21,4	483	42,00	3	009590010
20,8 13/16	27,0	527	53,00	3	009590011

959R

gommino e molla di ricambio per 956C - 956E - 957 - 959

959R/14	€	3	009590223
956C/14-956E/14	4,00	3	009590223
959R/16	4,00	3	009590224
956C/16-956E/16			
957/16-959/16			
959R/17,8	4,00	3	009590225
956C/17,8-956E/17,8			
959R/20,8	4,00	3	009590226
956C/20,8-956E/20,8			
957/20,8-959/20,8-959L			

960

chiavi a bussola con attacco quadro femmina 1/2" per iniettori motori Diesel

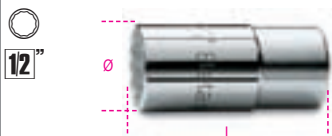

mm	ø mm	L mm	€	5	009600027
27	36,5	77	25,00	5	009600027

960A

chiavi a bussola con attacco quadro femmina 1/2" per iniettori motori Diesel

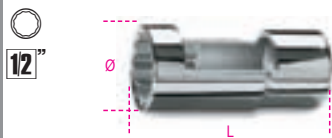

mm	ø mm	L mm	€	3	009600017
27	36,5	77	37,00	3	009600017

960BT

chiavi a bussola per le connessioni elettriche degli iniettori

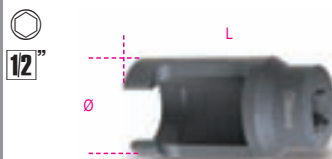

mm	ø mm	L mm	€	1	009600125
25	37,0	78	59,00	1	009600125
27	39,7	78	59,00	1	009600127
29	42,0	78	59,00	1	009600129
30	43,0	78	59,00	1	009600130

960BT/B

chiavi a bussola per le connessioni elettriche degli iniettori

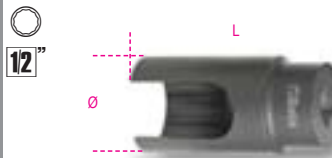

mm	ø mm	L mm	€	1	009600128
29	38,5	77	85,00	1	009600128

960S

chiavi a bussola con attacco quadro femmina 1/2" per iniettori motori Diesel

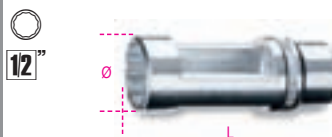

mm	ø mm	L mm	€	1	009600022
22	30	82	28,00	1	009600022

960SN

chiavi per candele di preriscaldamento motori Diesel



mm	ø mm	□	€	2	009600834
8	12,0	1/4	40,00	2	009600834
9	13,3	1/4	40,00	2	009600835
10	14,5	3/8	47,00	2	009600836
11	15,8	3/8	47,00	2	009600837
12	17,0	3/8	47,00	2	009600838

960SL

chiavi a bussola per sonda Lambda con attacco quadro femmina 1/2"

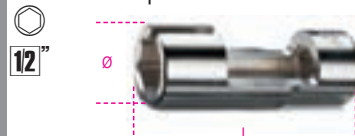

mm	ø mm	€	3	009600085
960SL85	33	43,00	3	009600085
○ 22xL= 85 mm				
960SL110	33	50,00	3	009600110
○ 22xL= 110 mm				

960F

chiave a bussola per ghiere portainiettori



mm	ø1 mm	●1 mm	●2 mm	€	1	009600148
28,3	22	32	22	30,00	1	009600148

960G

chiave a bussola per ghiere portainiettori



mm	ø1 mm	● mm	L mm	€	1	009600151
28,5	22	32	122	32,00	1	009600151

960L

chiave a bussola per ghiere portainiettori



mm	ø1 mm	L mm	€	1	009600153
30	22	122	35,00	1	009600153

960M

chiave a bussola per ghiere portainiettori

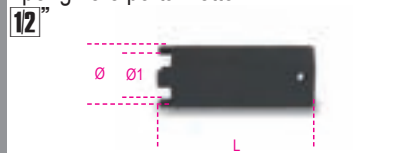

mm	ø1 mm	L mm	€	1	009600154
28,5	22	72	25,00	1	009600154

960H/C4

serie di bussole per ghiera portainiettori



960H/C4 € 85,00 1 009600152

960PMC

pompa manuale per taratura e controllo iniettori Diesel



Bar max. 400 € 565,00 1 009600200

960AVL

aspiratore di vapori



Bar max. 6 € 660,00 1 009600210

960KI

assortimento utensili per estrazione iniettori Diesel Common Rail

Permette la rimozione degli iniettori DELPHI-BOSCH-SIEMENS-DENSO



960KI € 1.890,00 1 009600235
530x470x140 mm - 20 kg

960PI

assortimento di alesatori per la pulizia della sede iniettori in cassetta di plastica

Per pulire i residui all'interno della sede iniettori

- Alesatore piatto da Ø 19 - 15 mm per iniettori universali
- Alesatore piatto da Ø 17 - 17 mm per iniettori Delphi/Bosch (BMW/PSA/Renault/Ford)
- Alesatore piatto da Ø 19 - 17 mm per iniettori Bosch (Mercedes CDI).
- Alesatore ad angolo da Ø 21 - 17 mm per iniettori Fiat/Iveco.
- Impugnatura



960PI € 90,00 1 009600215
250x130x50 mm - 600 g

960AVE

attrezzo verifica elettroiniettori Diesel Common Rail BOSCH, SIEMENS, DENSO e DELPHI.



960AVE € 185,00 1 009600245
430x310x50 mm - 2,0 kg

960K/AVE2

kit adattatori per 960AVE

(già inclusi nel 960AVE)



960K/AVE € 115,00 1 009600249
250x150x30 mm - 523 g

960CMB

strumento per controllo compressione su motori a benzina



Bar 4÷17 € 465,00 1 009600250
440x370x100 mm - 2,2 kg

960CMD

strumento per controllo compressione su motori Diesel



Bar 8÷40 € 500,00 1 009600270
440x370x100 mm - 2,4 kg

960KIT/1

3 finti iniettori e 1 finta candele per 960CMD



960KIT/1 € 180,00 1 009600600
240x210x45 mm - 710 g

960KC-M8

assortimento di utensili per la rimozione delle candele di preriscaldamento M8 spezzate o danneggiate

- Per candele con filetto M8x1.0 mm
- Permette di rimuovere agevolmente le candele spezzate bloccate nella testata



960 KC-M8 € 150,00 1 009600800

400x300x60 mm

960KPC

estrattore reversibile ad impulsi con coppia regolabile per candele di preriscaldamento

Coppia regolabile in 4 posizioni: 10-20-30-40 Nm



960KPC € 229,50 1 009600780

8-9-10-11-12 mm

420x185x60 mm

960P

tester per controllo pressione/depressione con accessori e adattatori



960P € 180,00 1 009600777

350x320x95 mm - 1,9 kg

960TP

tester pressione digitale

con modulo wireless per 960W



Caratteristiche tecniche:

- bar: 0÷80
- Risoluzione: 0,1 bar
- Funzione memorizzazione pressione massima
- Display LCD retroilluminato
- Software in 6 lingue (I, EN, F, ES, PL, NL)
- Funzione correzione pressione ambientale
- Precisione sensore: +/- 1% (0÷60 bar)
+/- 2% (60÷80 bar)
- Possibilità di rimuovere e sostituire il sensore

960TP € 560,00 1 009600300

280x240x77 mm - 800 g

960AD/TP2

set di adattatori per 960TP in valigetta di plastica



960AD/TP2 € 375,00 1 009600510

430x310x50 mm - 3,2 kg

960TAP

tester digitale alta pressione common rail

con modulo wireless per 960W



CARATTERISTICHE TECNICHE:

- Campo di misura: 0-2000 bar / 0-29000 psi
- Risoluzione: 1 bar
- Funzione memorizzazione valore massimo
- Display: Grafico LCD 64x128 pixels, retroilluminato
- Correzione pressione ambientale
- Precisione sensore: +/- 1%
- Avviamento motore automatico dal tester
- Limite sovrappressione: 3000 bar
- Software in 6 lingue: I-EN-F-ES-PL-NL

960TAP € 740,00 1 009600350

370x310x80 mm - 1,4 kg

960W

ricevitore wireless per PC (per 960TP - 960TAP)

Adatto per sistemi Windows 2000 SP3, XP, Vista e 7



DATI TECNICI

- Connessione: USB 1.0 e 2.0
- Frequenza di ricezione: 868 Mhz
- Alimentazione: Autoalimentata da USB
- Software: Cd-rom

960W € 168,00 1 009600400

962

levagomme



L mm	A mm	€		
300	21	17,00	5	009620003
400	25	20,00	5	009620004
500	27	26,00	3	009620005
600	27	33,00	3	009620006

963

leva con estremità a punta e piatta curva



L mm	A mm	€		
400	23	25,00	5	009630001

964

leva con estremità a punta e a becco



L mm	A mm	€	Icon	Code
400	46	22,50	5	009640001

965

leve con estremità piatta curva



L mm	A mm	L1 mm	€	Icon	Code
300	16	185	12,50	2	009650013
450	20	312	16,00	2	009650014
600	20	462	19,60	2	009650016



965/S3	€	Icon	Code
	48,00	1	009650019

966/C3

serie di 3 leve con testa snodata piatta curva



966/C3	€	Icon	Code
L=200-250-300 mm	89,00	1	009660103

355x140x65 mm - 1,8 kg

969A

chiave a bussola per serraggio dado mozzo

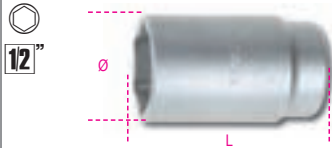

mm	Ø mm	L mm	€	Icon	Code
35	46	76	18,00	1	009690035

969B

chiave a bussola per serraggio dado mozzo

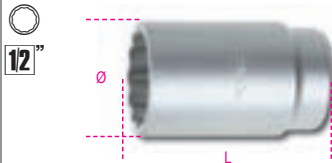

mm	Ø mm	L mm	€	Icon	Code
30	40,0	76	15,00	1	009690130
32	42,5	76	16,00	1	009690132
34	45,0	76	17,00	1	009690134
36	49,0	76	19,00	1	009690136

969/C5

serie di 5 chiavi a bussola per serraggio dado mozzo in valigetta di plastica



969/C5	€	Icon	Code
	85,00	1	009690200

- 969A 35
- 969B 30-32-34-36

970EA

chiavi a bussola Macchina per dadi assale



mm	mm	Ø mm	€	Icon	Code
98	36	122	172,00	1	009700398

970EB

chiavi a bussola Macchina per dadi assale



mm	mm	Ø mm	€	Icon	Code
95	36	126	199,00	1	009700595
110	36	133	199,00	1	009700410

970Q

chiavi a bussola Macchina per dadi rettangolari



L mm	mm	€	Icon	Code
56	3/4"	82,00	1	009700756
60	3/4"	87,00	1	009700760

970B

chiave a bussola per serraggio dadi mozzo Fiat Daily

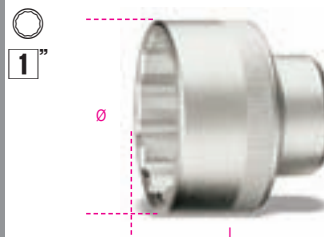

mm	Ø mm	L mm	€	Icon	Code
65	88	75	83,00	1	009700010

970C

chiavi a bussola Macchina bocca ottagonale per dadi mozzi



mm	□-Ø	€	Icon	Code
80	41 mm	125,00	1	009700808
95	3/4"	170,00	1	009700815
100	3/4"	174,00	1	009700820
109	41 mm	177,00	1	009700829
115	3/4"	177,00	1	009700835
120	41 mm	177,00	1	009700840

970OT

chiavi a bussola Macchina bocca ovale per dadi mozzi rimorchi



L mm	L1 mm	□-Ø	€	Icon	Code
65	61	3/4"	110,00	1	009700165
80	73	3/4"	125,00	1	009700180
96	90	3/4"	135,00	1	009700196
111	104	41 mm	160,00	1	009700211

978 - 979

chiavi a croce per dadi ruote

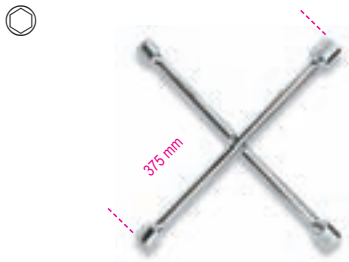

UNI/ISO 6788 DIN 3119

978	17x19x21x22 mm	€ 44,00	2	009780001
979	17x19x22x1/2 mm	44,00	2	009790001

982

chiavi a croce per dadi ruote

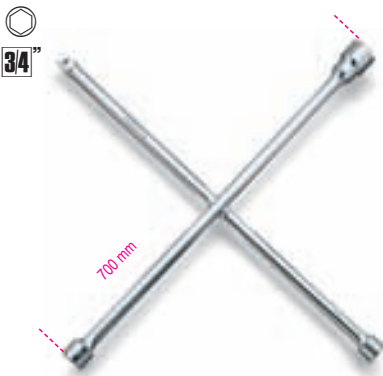

UNI/ISO 6788 DIN 3119

24x27x32x3/4 mm	€ 110,00	2	009820001
-----------------	----------	---	-----------

983

chiave a croce per dadi ruote auto

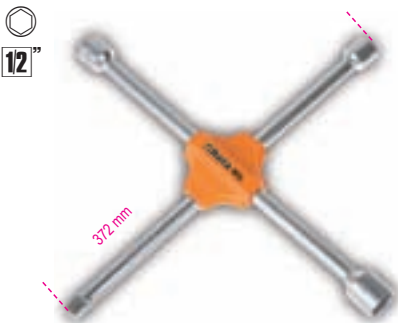

UNI/ISO 6788 DIN 3119

17x19x22x1/2 mm	€ 49,00	2	009830001
-----------------	---------	---	-----------

985

chiave a croce per dadi ruote autocarri



UNI/ISO 6788 DIN 3119

24x27x32x3/4 mm	€ 125,00	1	009850001
-----------------	----------	---	-----------

988/K4

serie di 4 scalpelli in plastica anti graffio



988/K4	€ 19,00	1	009880104
A= 19-21-25-38 mm			

989

pinza combinata per equilibratura ruote



L mm 250	€ 36,00	2	009890001
----------	---------	---	-----------

990

pinzetta a molla a punte fini diritte arrotondate, zigrinate in acciaio inossidabile



L mm 130	€ 9,00	5	009900001
----------	--------	---	-----------

991

pinzetta a molla a punte fini curve arrotondate, zigrinate in acciaio inossidabile



L mm 130	€ 11,00	5	009910001
----------	---------	---	-----------

992

pinzetta a molla con perno a punte fini diritte arrotondate zigrinate, in acciaio inossidabile



L mm 150	€ 12,00	5	009920001
----------	---------	---	-----------

993

pinzetta a molla con perno a punte fini curve arrotondate zigrinate, in acciaio inossidabile



L mm 145	€ 12,70	5	009930001
----------	---------	---	-----------

993PL

pinzetta a molla a punte fini curve arrotondate, zigrinate in acciaio inossidabile



L mm 150	€ 12,80	5	009930010
----------	---------	---	-----------

993G

pinzetta a molla con perno, a punte curve a gomito arrotondate, zigrinate in acciaio inossidabile



L mm 160	€ 11,30	5	009930030
----------	---------	---	-----------

994

pinzetta a molla a punte larghe diritte arrotondate, zigrinate in acciaio inossidabile



L mm 150	€ 9,30	5	009940001
----------	--------	---	-----------

994PL

pinzetta a molla a punte larghe diritte arrotondate, zigrinate in acciaio inossidabile



L mm 150 € 11,10 5 009940010

994TF

pinzetta a molla, antiacido antimagnetica, a punte larghe diritte arrotondate, zigrinate in acciaio inossidabile



L mm 150 € 14,80 5 009940020

996

pinzetta a molla a becchi diritti a spatola in acciaio inossidabile



L mm 150 € 10,00 5 009960001

998

pinzetta a molla a becchi larghi diritti incrociati, zigrinati in acciaio inossidabile



L mm 155 € 17,90 5 009980001

999

pinzetta a molla antiacido antimagnetica, a punte piatte arrotondate in acciaio inossidabile



L mm 115 € 13,10 5 009990011

999A

pinzette a molla, antiacido antimagnetica, a punte corte finissime in acciaio inossidabile



L mm 120 € 11,30 5 009990015

999B

pinzetta a molla, antiacido antimagnetica, a punte forti diritte in acciaio inossidabile



L mm 120 € 11,30 5 009990017

999C

pinzetta a molla, antiacido antimagnetica, a punte finissime diritte in acciaio inossidabile



L mm 110 € 12,20 5 009990019

999D

pinzetta a molla, antiacido antimagnetica, a punte finissime angolate, in acciaio inossidabile



L mm 115 € 14,40 5 009990021

999E

pinzetta a molla, antiacido antimagnetica, a punte finissime curve in acciaio inossidabile



L mm 120 € 12,20 5 009990023

999G

pinzetta a molla, antiacido, antimagnetica con dispositivo di bloccaggio, a punte finissime diritte in acciaio inossidabile



L mm 140 € 12,50 5 009990027

999/B6

serie di 6 pinzette a molla antiacido ed antimagnetiche



999/B6 € 79,50 1 009990050
999-999A-999B
999C-999D-999E

1008

pinze a becchi piatti lunghi zigrinati manici ricoperti con 2 strati di PVC antiscivolo



ISO 5745

L mm 160 L1 mm 51,5 € 18,00 5 010080006

1008BM

pinze a becchi piatti lunghi zigrinati impugnatura bimateriale



ISO 5745

L mm 160 L1 mm 51,5 € 22,00 5 010080036

1009

pinze a becchi mezzotondi lunghissimi zigrinati manici ricoperti con 2 strati di PVC antiscivolo



L mm 160 L1 mm 56,5 € 18,00 2 010090006

1009L/A

pinza a becchi mezzotondi lunghissimi diritti zigrinati, per impieghi speciali manici ricoperti con 2 strati di PVC antiscivolo



L mm 283 L1 mm 80 € 20,50 2 010090008

1009L/B

pinza a becchi mezzotondi lunghissimi zigrinati piegati a 45° per impieghi speciali manici ricoperti con 2 strati di PVC antiscivolo



L	L1	€	Hand	Icon
mm	mm			
273	73	21,50	2	010090009

1009L/C

pinza a becchi mezzotondi lunghissimi zigrinati piegati a 90° per impieghi speciali manici ricoperti con 2 strati di PVC antiscivolo



L	L1	€	Hand	Icon
mm	mm			
253	45	22,50	2	010090010

1010

pinze a becchi tonde lunghi manici ricoperti con 2 strati di PVC antiscivolo



ISO 5745

L	L1	€	Hand	Icon
mm	mm			
160	51,5	18,00	2	010100006

1010BM

pinze a becchi tonde lunghi impugnatura bimatetiale



ISO 5745

L	L1	€	Hand	Icon
mm	mm			
160	51,5	22,00	2	010100036

1032

pinze a becchi dritti per anelli elastici di sicurezza, per fori manici ricoperti in PVC



UNI 7914 DIN 5256

L	Ø	€	Hand	Icon
mm	mm			
140x0,9	8÷12	17,50	5	010320013
140x1,3	12÷25	16,50	5	010320014
180	19÷60	18,50	5	010320017
225	40÷100	23,00	3	010320021
300	85÷200	31,00	2	010320028

1033

pinze a becchi piegati a 45° per anelli elastici di sicurezza, per fori manici ricoperti in PVC



UNI 7914 DIN 5256

L	Ø	€	Hand	Icon
mm	mm			
140x0,9	8÷12	20,00	5	010330013
140x1,3	12÷25	19,00	5	010330014
180	19÷60	20,50	5	010330017
225	40÷100	26,00	3	010330021

1034

pinze a becchi piegati a 90° per anelli elastici di sicurezza, per fori manici ricoperti in PVC



UNI 7914 DIN 5256

L	Ø	€	Hand	Icon
mm	mm			
130x0,9	8÷12	20,00	5	010340013
130x1,3	12÷25	19,00	5	010340014
170	19÷60	20,50	5	010340017
210	40÷100	26,00	3	010340021
290	85÷200	33,50	2	010340028

1034L

pinza a becchi piegati a 90° lunghi per anelli elastici di sicurezza, per fori manici ricoperti in PVC



L	Ø	€	Hand	Icon
mm	mm			
192	40÷100	48,00	2	010340320

1036

pinze a becchi dritti per anelli elastici di sicurezza per alberi manici ricoperti in PVC



UNI 7915 DIN 5254

L	Ø	€	Hand	Icon
mm	mm			
140x0,9	3÷10	19,60	5	010360013
140x1,3	10÷25	18,60	5	010360014
175	19÷60	19,60	5	010360017
225	40÷100	25,00	3	010360021
300	85÷200	38,50	2	010360028

1037

pinze a becchi piegati a 45° per anelli elastici di sicurezza per alberi manici ricoperti in PVC



UNI 7915 DIN 5254

L	Ø	€	Hand	Icon
mm	mm			
140x0,9	3÷10	21,50	5	010370013
140x1,3	10÷25	20,50	5	010370014
175	19÷60	21,50	5	010370017
225	40÷100	26,50	3	010370021

1038

pinze a becchi piegati a 90° per anelli elastici di sicurezza per alberi manici ricoperti in PVC

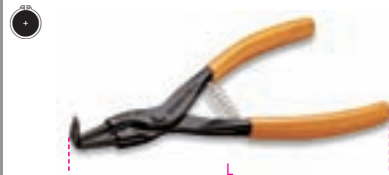

UNI 7915 DIN 5254

L	Ø	€	Hand	Icon
mm	mm			
135x0,9	3÷10	21,50	5	010380013
135x1,3	10÷25	20,50	5	010380014
175	19÷60	21,50	5	010380017
220	40÷100	26,50	3	010380021
300	85÷200	40,50	2	010380028

1039

pinza reversibile a becchi dritti per anelli elastici di sicurezza per fori e alberi, manici ricoperti in PVC



L	Ø	Ø	€	Hand	Icon
mm	mm	mm			
150	10÷15	6÷25	45,00	2	010390015

1044

pinza regolabile
cerniera sovrapposta
manici ricoperti con 2 strati di PVC antiscivolo

· modello a nove posizioni

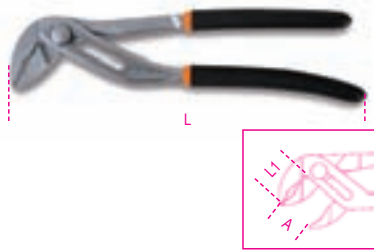

ISO 8976

L mm	A max mm	L1 mm	€	Icon	Icon
250	48	39	24,00	5	010440250

1044F

pinza regolabile, fosfatata
cerniera sovrapposta
manici ricoperti in PVC

· modello a nove posizioni

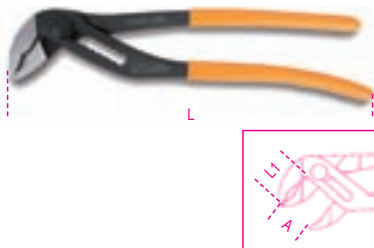

ISO 8976

L mm	A max mm	L1 mm	€	Icon	Icon
250	48	39	17,50	5	010440015

1046

pinza regolabile
cerniera a cremagliera sovrapposta
manici ricoperti in PVC

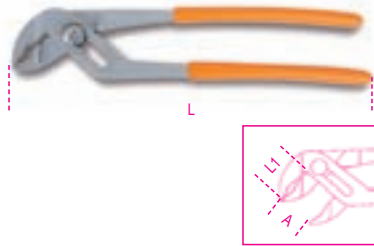

ISO 8976

L mm	A max mm	L1 mm	€	Icon	Icon
240	28	33	27,00	5	010460240
400	107	55	45,00	1	010460400

1047

pinza regolabile a pulsante,
manici ricoperti con due strati
di PVC antiscivolo

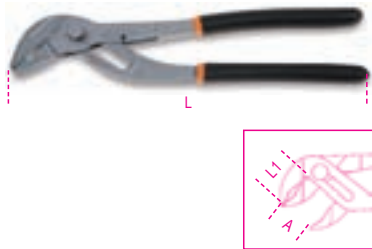

L mm	A max mm	L1 mm	€	Icon	Icon
240	36	35	33,50	2	010470240
300	50	48	49,00	1	010470300

1047BM

pinza regolabile a pulsante con impugnatura
bimateriale

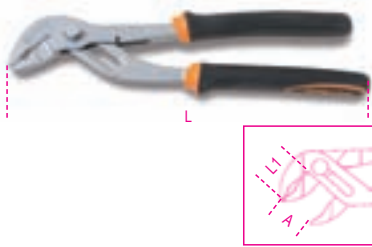

L mm	A max mm	L1 mm	€	Icon	Icon
240	36	35	38,50	2	010470340

1048

pinze regolabili cerniera chiusa
manici ricoperti con 2 strati di PVC antiscivolo

· modello a nove posizioni

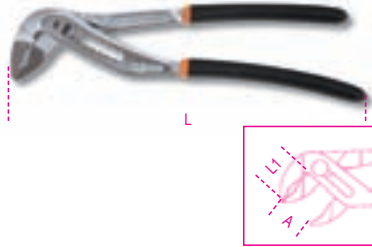

ISO 8976

L mm	A max mm	L1 mm	€	Icon	Icon
175	30	29	23,00	3	010480010
250	48	39	26,00	5	010480015
300	56	47	38,00	2	010480020

1048BM

pinza regolabile a cerniera chiusa,
impugnatura bimateriale

· nuovo modello a nove posizioni

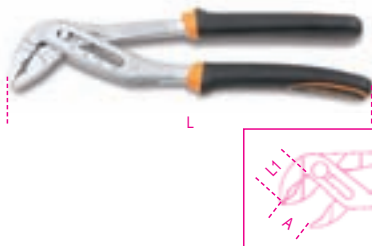

L mm	A max mm	L1 mm	€	Icon	Icon
250	48	39	32,00	3	010480215

1048V

pinze regolabili
verniciate arancio
cerniera chiusa
· modello a nove posizioni



ISO 8976

L mm	A max mm	L1 mm	€	Icon	Icon
175	30	29	19,00	3	010480110
250	48	39	22,00	5	010480115
300	56	47	33,00	2	010480120

1050

pinza autobloccante
a doppia regolazione



L mm	€	Icon	Icon
220	59,00	2	010500022

1051

pinza autobloccante
a doppia regolazione, ganasce lunghe

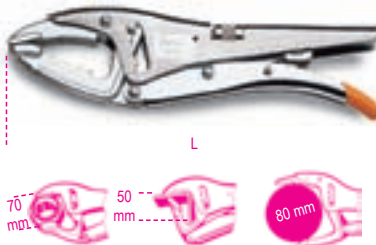

L mm	€	Icon	Icon
255	65,00	2	010510025

1051GM

pinza autobloccante
a doppia regolazione, ganaschia oscillante

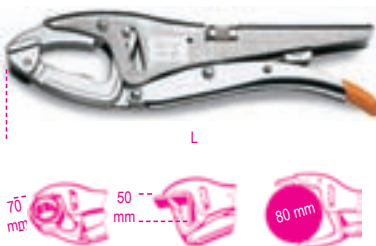

L mm	€	Icon	Icon
255	69,00	2	010510250

Beta



1051L

pinza autobloccante a doppia regolazione a grande capacità



L mm 270 € 74,00 2 010510100

1051XL

pinza autobloccante a doppia regolazione a grande capacità, ganasce extra lunghe



L mm 270 € 86,00 2 010510140

1052

pinze regolabili autobloccanti ganasce concave

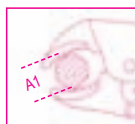

L mm	A1 max mm	€		
140	22	19,50	3	010520014
190	36	22,00	3	010520019
240	42	23,00	3	010520024
300	55	39,50	2	010520030

1053

pinza regolabile autobloccante ganascia oscillante

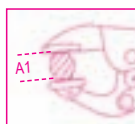

L mm 240 € 33,00 2 010530024

1054

pinza regolabile autobloccante ganasce diritte

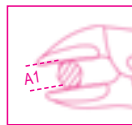

L mm 235 A1 max mm 40 € 26,50 2 010540022

1055

pinza regolabile autobloccante ganasce sagomate

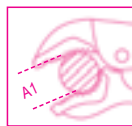

L mm 250 A1 max mm 60 € 28,00 2 010550024

1056

pinza regolabile autobloccante per frigoristi



L mm 190 € 33,00 2 010560019

1057A

pinza automatica autobloccante con regolazione della forza



L mm 240 € 39,00 2 010570124

1058

pinze regolabili autobloccanti becchi lunghi



L mm	A1 max mm	A2 max mm	€		
180	38	/	24,00	2	010580018
240	65	100	33,00	2	010580024
310	80	150	39,00	2	010580031

1060

pinze regolabili autobloccanti ganasce a forcella

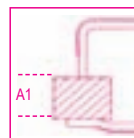

L mm	A1 max mm	€		
200	50	30,00	2	010600020
280	80	39,00	2	010600028

1061

pinza regolabile autobloccante ganasce a forcella

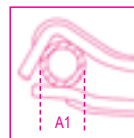

L mm 290 A1 max mm 80 € 43,00 2 010610028

Beta

1062

pinze regolabili autobloccanti
ganasse a collo di cigno



L mm	A1 max mm	€	Icon	Icon
170	50	24,00	2	010620017
290	120	31,00	2	010620029
460	250	54,00	2	010620046

1062AL

pinze regolabili autobloccanti
ganasse a collo di cigno
in alluminio



L mm	A1 max mm	€	Icon	Icon
290	104	39,50	2	010620329

1062GM

pinze regolabili autobloccanti
ganasse a collo di cigno oscillanti



L mm	A1 max mm	€	Icon	Icon
170	45	27,00	2	010620217
290	88	36,00	2	010620229
460	260	66,00	2	010620246

1063

pinza regolabile autobloccante
per lattonieri



L mm	A1 max mm	€	Icon	Icon
200	30	41,00	2	010630020

1064

pinza regolabile autobloccante
a catena



L mm	∅ mm	€	Icon	Icon
240	150	62,00	2	010640024

1065F

pinza foralamiera

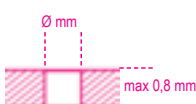

∅ mm	L mm	€	Icon	Icon
5	228	89,00	2	010650010
6	228	89,00	2	010650015

1065P

pinza piegalamiera



L mm	€	Icon	Icon
228	89,00	2	010650020

1077

pinza a becchi larghi dritti
per lattonieri
manici ricoperti in PVC



L mm	A mm	L1 mm	€	Icon	Icon
280	60	53	41,00	1	010770026

1078

pinza a becchi larghi piegati a 45°
per lattonieri
manici ricoperti in PVC



L mm	A mm	L1 mm	€	Icon	Icon
280	60	77	42,00	1	010780026

1080D

tronchesi a taglianti diagonali rasi
manici ricoperti con 2 strati
di PVC antiscivolo
Per taglio di materiali plastici



α	L mm	L1 mm	€	Icon	Icon
15°	160	22	20,00	3	010800015
45°	160	22	25,00	3	010800045

1082

tronchesi a taglianti diagonali
manici ricoperti con 2 strati
di PVC antiscivolo



UNI/ISO 5749

L mm	L1 mm	∅ mm	€	Icon	Icon
140	20	1,6	17,50	5	010820004
160	22	1,6	19,00	5	010820006

1082BM

tronchesi a taglianti diagonali
impugnatura bimatériale



UNI/ISO 5749

L mm	L1 mm	∅ mm	€	Icon	Icon
140	20	1,6	22,50	3	010820034
160	22	1,6	25,00	3	010820036

1084

tronchesi a grande effetto
a taglienti diagonali, manici ricoperti
con 2 strati di PVC antiscivolo



UNI/ISO 5749

L	L1	■	€	🔧	📦
mm	mm	mm			
140	20	1,4	19,50	5	010840004
160	22	1,6	21,00	5	010840006
180	25	1,8	25,50	3	010840008
200	28	2,0	26,50	3	010840010

1084BM

tronchesi a grande effetto
a taglienti diagonali
impugnatura bimatereale



UNI/ISO 5749

L	L1	■	€	🔧	📦
mm	mm	mm			
140	20	1,4	24,50	3	010840034
160	22	1,6	26,50	3	010840036
180	25	1,8	31,00	3	010840038
200	28	2,0	34,50	3	010840040

1088

tronchesi a grande effetto
a taglienti frontali
manici ricoperti con 2 strati
di PVC antiscivolo

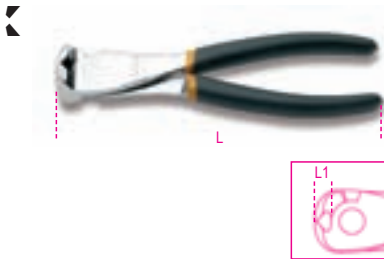

UNI/ISO 5748

L	L1	■	€	🔧	📦
mm	mm	mm			
160	9	1,6	25,00	2	010880006
200	11	2,0	33,00	2	010880010

1088BM

tronchesi a grande effetto
a taglienti frontali
impugnatura bimatereale

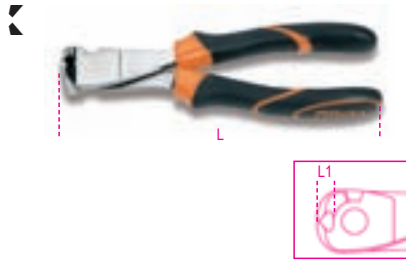

UNI/ISO 5748

L	L1	■	€	🔧	📦
mm	mm	mm			
160	9	1,6	31,50	2	010880036
200	11	2,0	42,50	2	010880040

1092V

tronchesi a doppia leva
a taglienti frontali
tipo pesante

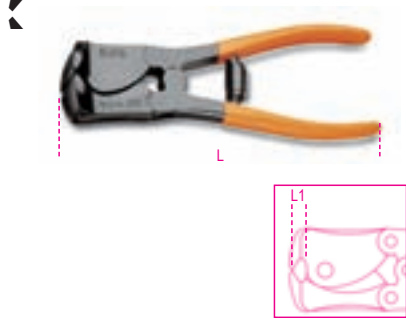

UNI/ISO 5748

L	L1	■	€	🔧	📦
mm	mm	mm			
180	8	2,0	75,00	2	010920280
200	9	2,5	85,00	2	010920310

1094V

tronchese a doppia leva
taglienti diagonali
tipo pesante



UNI/ISO 5748

L	L1	■	€	🔧	📦
mm	mm	mm			
200	23	2,5	75,00	2	010940200

1095N

tronchese a doppia leva
a taglienti diagonali



L	L1	■	€	🔧	📦
mm	mm	mm			
195	26	1,6	40,00	2	010950010

1096

tenaglie per falegnami



ISO 9243

L	L1	€	🔧	📦
~	mm			
160	21	14,00	5	010960016
200	23	17,50	5	010960020
250	30	21,00	5	010960025

1098

tenaglie per cementisti

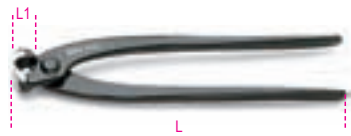

ISO 9242 DIN 5242

L	L1	€	🔧	📦
~	mm			
190	12	15,00	5	010980190
220	13	16,00	5	010980220
250	15	18,00	5	010980250
280	18	19,50	5	010980280

1098PL

tenaglie per cementisti
manici ricoperti in PVC



ISO 9242 DIN 5242

L	L1	€	🔧	📦
~	mm			
220	13	17,50	5	010980320
250	15	19,50	5	010980350
280	18	21,00	5	010980380

1101

troncabulloni



L	L1	€	🔧	📦
mm	mm			
300	12	42,00	2	011010030
350	14	52,00	2	011010035
450	18	64,00	1	011010045
600	24	85,00	1	011010060
750	30	113,00	1	011010075
900	36	148,00	1	011010090

L	R = 80	R = 140	■	🔧
mm	Kgf/mm²	Kgf/mm²	g	
mm	Ø mm	Ø mm		
300	5	4	745	🔧
350	6	5	1043	🔧
450	7	6	1537	🔧
600	9	7	2540	🔧
750	11	8	3870	🔧
900	12	9	6170	🔧

Beta

1101R

lame di ricambio per 1101



mm	1101	€		
300	300	26,50	1	011010130
350	350	30,50	1	011010135
450	450	37,50	1	011010145
600	600	50,00	1	011010160
750	750	62,00	1	011010175
900	900	82,00	1	011010190

1102

minitroncabulloni

R = \approx 80 Kg/mm²



L	mm	€		
230	4	27,00	3	011020020

1104

tagliafuni per funi flessibili in acciaio
impugnature in materiale plastico

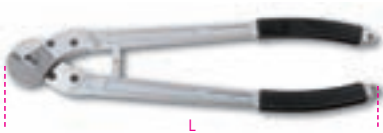

L	mm	mm	€		
420	12		99,00	1	011040004
600	16		160,00	1	011040006

1104R

lame di ricambio per 1104



mm	€		
420	66,00	1	011040014
600	95,00	1	011040016

1105

fustelle in acciaio
brunite

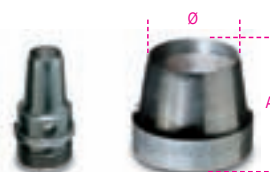

Ø	A	mm	mm	€		
2	27			9,80	1	011050002
3	27			9,80	1	011050003
4	27			9,80	1	011050004
5	27			9,80	1	011050005
6	27			9,80	1	011050006

Ø	A	mm	mm	€		
7	27			9,80	1	011050007
8	27			9,80	1	011050008
9	27			9,80	1	011050009
10	27			9,80	1	011050010
12	27			12,00	1	011050012
14	27			12,00	1	011050014
16	27			12,00	1	011050016
18	27			12,00	1	011050018
20	27			12,00	1	011050020
22	32			15,50	1	011050022
24	32			15,50	1	011050024
26	32			15,50	1	011050026
28	32			15,50	1	011050028
30	32			15,50	1	011050030
32	37			19,50	1	011050032
34	37			19,50	1	011050034
36	37			19,50	1	011050036
38	37			19,50	1	011050038
40	37			19,50	1	011050040
42	42			24,00	1	011050042
44	42			24,00	1	011050044
46	42			24,00	1	011050046
48	42			24,00	1	011050048
50	42			24,00	1	011050050

1105T30

battifustella per fustelle 1105
da 3 a 30 mm



L	mm	€		
155		100,00	1	011050201

1105T50

battifustella per fustelle 1105
da 2 a 50 mm



L	mm	€		
155		105,00	1	011050202

1105AD-50

adattatore per battifustella 1105T50



Ø	mm	€		
57		68,00	1	011050210

1105/C15T

assortimento di 15 fustelle
da 3 a 30 mm e 1 accessorio



1105/C15T	€		
	225,00	1	011050251

1105	3 - 4 - 6 - 8 - 10 - 12 - 14 - 16 - 18 - 20 - 22 - 24 - 26 - 28 - 30 mm
1105T30	
230x190x50 mm	

1105/C29T

assortimento di 29 fustelle
da 2 a 50 mm e 2 accessori



1105/C29T	€		
	400,00	1	011050252

1105	2 - 3 - 4 - 5 - 6 - 7 - 8 - 9 - 10 - 12 - 14 - 16 - 18 - 20 - 22 - 24 - 26 - 28 - 30 - 32 - 34 - 36 - 38 - 40 - 42 - 44 - 46 - 48 - 50 mm
1105T50	
1105AD-50	
325x280x55 mm	

1112

cesoie modello americano
lame larghe diritte

R = 60 Kg/mm²

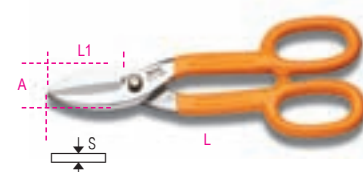

L	L1	S	A	mm	mm	mm	mm	€		
200	50	0,5	26					18,00	2	011120020
250	62	0,8	33					22,00	2	011120025
300	76	1,0	37					28,00	2	011120030
375	105	1,2	44					43,00	1	011120037



1114

cesoie modello americano
lame strette diritte
R = 60 Kgf/mm²

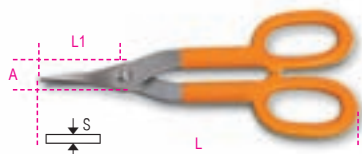

L	L1	S	A	€		
mm	mm	mm	mm			
250	58	0,5	15	17,00	1	011140265
350	76	1	22	24,00	1	011140340

1118

cesoia antinfortunistica per taglio reggia

Fe = acciaio comune
Inox = acciaio inossidabile



L	L1	Fe	Inox	€		
mm	mm	S mm	S mm			
310	42	1	0,8	30,00	2	011180001

1120A

cesoia roditrice

Fe = acciaio comune



L	Fe	€		
mm	S mm			
280	1,2	51,00	1	011200101

1120ARL - ARG

ricambi per 1120A



	€		
1120ARL	11,00	1	011200110
1120ARG	14,00	1	011200120

1122

cesoia a doppia leva
lame diritte
Inox = acciaio inossidabile



L	L1	Inox	A	€		
mm	mm	S mm	mm			
250	40	1	24	24,00	2	011220020

1123

cesoia a doppia leva destrorsa
lame curve
Inox = acciaio inossidabile



L	L1	Inox	A	€		
mm	mm	S mm	mm			
250	40	1	24	24,00	2	011230020

1124

cesoia a doppia leva sinistrorsa
lame curve
Inox = acciaio inossidabile



L	L1	Inox	A	€		
mm	mm	S mm	mm			
250	40	1	24	24,00	2	011240020

1125

cesoia a doppia leva
per tagli diritti e destrorsi
Inox = acciaio inossidabile

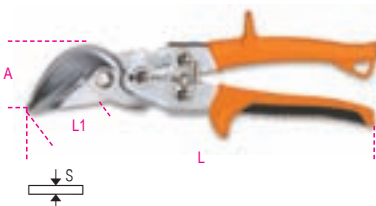

L	L1	Inox	A	€		
mm	mm	S mm	mm			
250	35	1	46	39,00	2	011250020

1126

cesoia a doppia leva
per tagli diritti e sinistrorsi
Inox = acciaio inossidabile

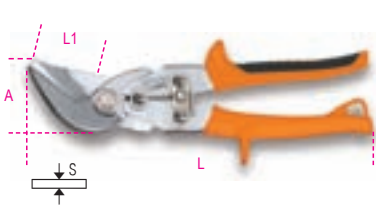

L	L1	Inox	A	€		
mm	mm	S mm	mm			
250	35	1	46	39,00	2	011260020

1127

forbici per telefonisti lame diritte



L	L1	€		
mm	mm			
150	35	11,20	5	011270001

1128BCX

forbici per elettricisti
lame dirite in acciaio inossidabile
con microdentatura, gola tranciacavo e
crimpatore per terminali a tubetto

con custodia plastica snodata



L	L1			€		
mm	mm	mm ²	mm ²			
155	55	50	1=4	21,00	5	011280080

1128BMX

forbici per elettricisti
lame dirite in acciaio inossidabile
con microdentatura



L	L1	€		
mm	mm			
145	54	12,80	5	011280050

1128BSX

forbici per elettricisti con svasatore
lame dirite in acciaio inossidabile

studiate per allargare fori su plastica
e chiudere tubi corrugati
• con custodia plastica snodata

BREVETTATO



L	L1	€		
mm	mm			
145	50	21,50	5	011280060

1128BTX

forbici per elettricisti
lame dirite in acciaio inossidabile
con microdentatura e gola tranciacavo

•con custodia plastica snodata



L	L1	€		
mm	mm			
155	55	16,50	5	011280070

1128BM

forbici per elettricisti
lame diritte



L mm	L1 mm	€		
145	50	11,50	5	011280000

1129BM

forbici per elettricisti
lame curve



L mm	L1 mm	€		
145	44	12,50	5	011290000

1130BMX

forbici multiuso
lame diritte in acciaio inossidabile
con microdentatura



L mm	L1 mm	€		
200	58	20,50	1	011300000

1131CK

forbici per Kevlar® e fibre ottiche

in acciaio specificatamente studiato per operare su materiali
antitaglio come fibre aramidiche
Anche per fibre ottiche



L mm	L1 mm	€		
203	75	57,00	1	011310001

1132

tagliacavi
manici ricoperti con 2 strati
di PVC antiscivolo per taglio di cavi isolati
di rame e alluminio



UNI 8791				
L mm	Ø mm	€		
170	10	34,00	2	011320107
230	17	42,00	2	011320113

1132BM

tagliacavi
impugnatura bimatereale
per cavi isolati in rame e alluminio



UNI 8791				
L mm	Ø mm	€		
170	10	44,00	2	011320137
230	17	54,00	2	011320143

1133

tagliacavi
per cavi in rame flessibile
fino a 325 mm²

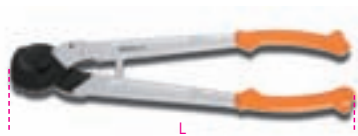

L mm	Ø mm	€		
600	30	118,00	1	011330001

1133RL

lama di ricambio per 1133



1133RL				
€				
88,00	1	011330011		

1134

tagliacavi a cricchetto



L mm	Ø mm	mm ²	€	
260	35	250	350,00	1 011340032

1134RL

lama di ricambio per 1134



1134RL				
€				
165,00	1	011340132		

1134A

tagliacavi a cricchetto



L mm	Ø mm	mm ²	€	
240	45	400	530,00	1 011340045

1134A/RL

lama di ricambio per 1134A



1134A/RL				
€				
260,00	1	011340145		

1136

tagliacavi per cavi di acciaio

Ø 5 mm per cavi con R ≤ 160 Kg/mm²
Ø 4 mm per bulloni in acciaio dolce



L mm	€			
165	41,00	2	011360001	

1142BM

pinza spellafili
impugnatura bimatereale



UNI 7923				
L mm	mm ²	€		
160	0,5÷6	26,00	3	011420036

1143

pinza spellafili



L mm	mm ²	€		
165	1÷6	63,00	1	011430001

1143R

lame di ricambio per 1143

1143R	€ 15,00		1	011430011
-------	---------	--	---	-----------

1144

spellacavi



L mm		€		
140	6÷20	59,00	1	011440014

1144RC

coltello di ricambio per 1144



1144RC	€ 10,00		1	011440015
--------	---------	--	---	-----------

1144D

spellacavi



L mm		€		
170	4,5÷40	69,00	1	011440010

1144D/RG

gancio di ricambio per 1144D



1144D/RG	€ 22,00		1	011440012
----------	---------	--	---	-----------

1144D/RL

lame di ricambio per 1144D

1144D/RL	€ 35,00		1	011440011
----------	---------	--	---	-----------

1145

pinza spellafili con dispositivo di taglio
modello automatico



L mm		€		
165	0,25÷1,5	95,00	1	011450018

1145RG

coppia di ganasce di ricambio
per 1145



1145RG	€ 23,00		1	011450020
--------	---------	--	---	-----------

1148A

pinza spellafili autoregolabile
con dispositivo di taglio
≠10 mm² (8 AWG) conduttori flessibili
≠1,5 mm² (16 AWG) conduttori rigidi



L mm		€		
190	0,02÷10 34÷8 AWG	120,00	1	011480100

1148A/R

lame di ricambio per 1148A



1148A/R	€ 50,00		1	011480102
---------	---------	--	---	-----------

1148B

pinza spellafili autoregolabile
con dispositivo di taglio
≠10 mm² (8 AWG) conduttori flessibili
≠1,5 mm² (16 AWG) conduttori rigidi



L mm		€		
190	4÷16 12÷6 AWG	140,00	1	011480200

1148B/R

lame di ricambio per 1148B



1148B/R	€ 65,00		1	011480202
---------	---------	--	---	-----------

1149F

pinza spellafili frontale autoregolabile,
con dispositivo di taglio



L mm		€		
175	0,2 ÷ 6 28÷17 AWG	12,00	1	011490010

1150

pinze universali
cromate lucide
manici ricoperti con 2 strati
di PVC antiscivolo



ISO 5746

L mm	L1 mm		€		
160	37	1,6	15,40	5	011500006
180	41	1,8	17,00	5	011500008
200	45	2,0	18,70	5	011500010
220	50	2,0	20,00	2	011500012

1150BM

pinze universali
cromate lucide
impugnatura bimatereale



ISO 5746

L mm	L1 mm		€		
160	37	1,6	20,00	3	011500036
180	41	1,8	22,00	3	011500038
200	45	2,0	24,50	3	011500040
220	50	2,0	26,00	2	011500042

1153

pinze regolabili a due posizioni
manici ricoperti in PVC



L mm	L1 mm	€		
160	37	18,50	2	011530016
200	50	19,50	2	011530020

1162

pinze a becchi piatti
lunghissimi diritti zigrinati
manici ricoperti con 2 strati
di PVC antiscivolo



ISO 5745

L mm	L1 mm		€		
160	58	1,6	17,50	5	011620006
200	86	1,6	20,00	5	011620010

1162BM

pinze a becchi piatti
lunghissimi diritti zigrinati
impugnatura bimatereale



ISO 5745

L	L1	mm	€	Impugnatura	Articolo
mm	mm	mm			
160	58	1,6	22,00	3	011620036
200	86	1,6	25,50	3	011620040

1164

pinze a becchi piatti
lunghissimi piegati zigrinati
manici ricoperti con 2 strati
di PVC antiscivolo



ISO 5745

L	L1	mm	€	Impugnatura	Articolo
mm	mm	mm			
160	54	1,6	19,00	5	011640006
200	76	1,6	22,00	5	011640010

1164BM

pinze a becchi piatti
lunghissimi piegati zigrinati
impugnatura bimatereale



ISO 5745

L	L1	mm	€	Impugnatura	Articolo
mm	mm	mm			
160	54	1,6	24,00	3	011640036
200	76	1,6	28,00	3	011640040

1166

pinze a becchi mezzotondi lunghissimi
diritti zigrinati
manici ricoperti con 2 strati
di PVC antiscivolo



ISO 5745

L	L1	mm	€	Impugnatura	Articolo
mm	mm	mm			
160	56	1,6	17,50	5	011660006
200	76	1,6	20,00	5	011660010

1166BM

pinze a becchi mezzotondi lunghissimi
diritti zigrinati
impugnatura bimatereale



ISO 5745

L	L1	mm	€	Impugnatura	Articolo
mm	mm	mm			
160	56	1,6	22,00	3	011660036
200	76	1,6	25,50	3	011660040

1168

pinze a becchi mezzotondi lunghissimi
piegati zigrinati
manici ricoperti con 2 strati
di PVC antiscivolo



ISO 5745

L	L1	mm	€	Impugnatura	Articolo
mm	mm	mm			
160	54	1,6	19,00	5	011680006
200	76	1,6	22,00	5	011680010

1168BM

pinze a becchi mezzotondi lunghissimi
piegati zigrinati
impugnatura bimatereale



ISO 5745

L	L1	mm	€	Impugnatura	Articolo
mm	mm	mm			
160	54	1,6	24,00	3	011680036
200	70	1,6	28,00	3	011680040

1171BM

pinza per elettronica
a becchi piatti corti lisci
impugnatura bimatereale



ISO 9655

L	L1	A	B	€	Impugnatura	Articolo
mm	mm	mm	mm			
125	18	12	8	33,00	2	011710101

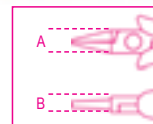

1172BM

pinza per elettronica
a becchi piatti lunghi lisci
impugnatura bimatereale



ISO 9655

L	L1	A	B	€	Impugnatura	Articolo
mm	mm	mm	mm			
140	40	12	8	33,00	2	011720101

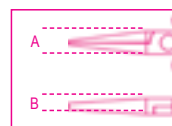

1172BM/P

pinza per elettronica
a becchi piatti lunghi piegati lisci
impugnatura bimatereale



L	L1	A	B	€	Impugnatura	Articolo
mm	mm	mm	mm			
140	38	12	13	37,00	2	011720102

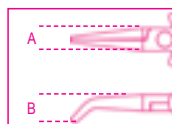

Beta

1173BM

pinza per elettronica
a becchi tondi corti
impugnatura bimatereale



ISO 9655

L	L1	A	B	€	Icon	Icon
mm	mm	mm	mm			
125	22	12	8	33,00	2	011730101

1177BM/Z

pinza per elettronica
a becchi mezzotondi lunghi zigrinati
impugnatura bimatereale



ISO 9655

L	L1	A	B	€	Icon	Icon
mm	mm	mm	mm			
140	39	12	8	37,00	2	011770113

1182BM

tronchese per elettronica
a taglienti diagonali semirasi
becchi assottigliati
impugnatura bimatereale



ISO 9654

L	L1	A	Cu	€	Icon	Icon
mm	mm	mm	mm			
120	11	10	1	37,00	2	011820101

1175BM

pinza per elettronica
a becchi mezzotondi corti lisci
impugnatura bimatereale



ISO 9655

L	L1	A	B	€	Icon	Icon
mm	mm	mm	mm			
140	29	12	8	33,00	2	011750101

1178BM

pinza per elettronica
a becchi mezzotondi lunghi lisci rastremati
impugnatura bimatereale



ISO 9655

L	L1	A	B	€	Icon	Icon
mm	mm	mm	mm			
140	37	12	8	37,00	2	011780101

1183BM

tronchese per elettronica
a taglienti diagonali semirasi
becchi arrotondati
impugnatura bimatereale



ISO 9654

L	L1	A	Cu	€	Icon	Icon
mm	mm	mm	mm			
120	11	10	1	37,00	2	011830101

1177BM

pinza per elettronica
a becchi mezzotondi lunghi lisci
impugnatura bimatereale



ISO 9655

L	L1	A	B	€	Icon	Icon
mm	mm	mm	mm			
140	38	12	8	33,00	2	011770101

1178BM/P

pinza per elettronica
a becchi mezzotondi lunghi lisci rastremati
piegati
impugnatura bimatereale



L	L1	A	B	€	Icon	Icon
mm	mm	mm	mm			
140	36,5	12	12	37,00	2	011780102

1184BM

tronchese per elettronica
a taglienti diagonali rasi
becchi arrotondati
impugnatura bimatereale



ISO 9654

L	L1	A	Cu	€	Icon	Icon
mm	mm	mm	mm			
120	11	10	1	38,00	2	011840101
130	13	12,5	1,25	38,00	2	011840102

1185BM

tronchese per elettronica
a taglienti diagonali rasi
becchi assottigliati
impugnatura bimatériale



ISO 9654

L	L1	A	Cu	€		
mm	mm	mm	mm			
120	11	10	1	37,00	2	011850101
130	13	12,5	1,25	37,00	2	011850102

1186BM

tronchese per elettronica
a taglienti diagonali rasi
becchi assottigliati scaricati
impugnatura bimatériale



ISO 9654

L	L1	A	Cu	€		
mm	mm	mm	mm			
120	11	10	1	37,00	2	011860101
130	13	12,5	1,25	40,00	2	011860102

1188BM

tronchese per elettronica
a taglienti diagonali normali
impugnatura bimatériale



ISO 9654

L	L1	A	Cu	€		
mm	mm	mm	mm			
125	12	12	1,25	37,00	2	011880101
130	17	15	2	37,00	2	011880102

1190BM

tronchese per elettronica
a taglienti frontali normali
impugnatura bimatériale



ISO 9654

L	L1	A	Cu	€		
mm	mm	mm	mm			
120	12	12	1,25	37,00	2	011900113

1191BM

tronchese per elettronica
a taglienti obliqui rasi
becchi lunghi sottili
impugnatura bimatériale



ISO 9654

L	L1	A	Cu	€		
mm	mm	mm	mm			
130	8	12	0,8	37,00	2	011910101

1191BM/L

tronchese per elettronica
a taglienti obliqui rasi e spellafilo
impugnatura bimatériale



ISO 9654

L	L1	A	Cu	€		
mm	mm	mm	mm			
130	18	12	1	38,00	2	011910110

1200MS

magnetizzatore-smagnetizzatore

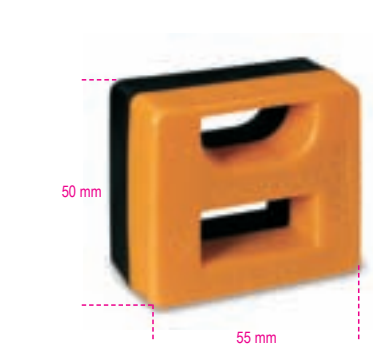

1200MS	€		
	11,00	5	012000000

1201

giravite per viti
a testa con intaglio



SxAxL	L1	Ø	€		
mm	mm	mm			
0,4x2,5x50	146	2,5	2,70	5	012010003
0,4x2,5x75	166	2,5	2,80	5	012010006
0,5x3x75	171	3,0	2,90	5	012010009
0,5x3x100	196	3,0	3,15	5	012010012
0,6x3,5x75	171	3,5	3,20	5	012010018
0,6x3,5x100	196	3,5	3,25	5	012010021
0,8x4x100	196	4,0	3,30	5	012010030
0,8x4x125	221	4,0	3,50	5	012010033
0,8x4x150	246	4,0	3,70	5	012010036
1,0x5,5x100	209	5,0	4,00	5	012010039
1,0x5,5x125	234	5,0	4,20	5	012010040
1,0x5,5x150	259	5,0	4,35	5	012010042
1,2x6,5x100	220	6,0	4,75	5	012010048
1,2x6,5x150	270	6,0	5,00	5	012010051
1,2x8x150	282	8,0	6,40	3	012010057
1,2x8x200	332	8,0	6,90	3	012010060
1,6x10x200	332	9,5	7,90	3	012010066



1201/S6	€		
0,5x3x75-0,6x3,5x100 0,8x4x100-1,0x5,5x100 1,2x8x150-1,6x10x200 mm	27,50	1	012010206

1201N

giravite per viti a testa con intaglio
tipo cortissimo



ISO 2380

SxAxL	L1	Ø	€		
mm	mm	mm			
0,8x4x30	86,5	4	3,80	3	012010103
1,2x6,5x30	86,5	6	4,00	3	012010106

1201DZ

giravite per viti con impronta Dzus®



1201DZ	L mm	L1 mm	€	🔧	📦
	53	173	9,20	2	012010501

1202

giravite per viti con impronta a croce Phillips®



UNI/ISO 8764 DIN 5262

PHxDxL mm	L1 mm	€	🔧	📦
0x3x60	156	2,80	5	012020003
0x3x100	200	3,10	5	012020006
1x4,5x80	189	3,75	5	012020009
1x4,5x120	229	3,95	5	012020012
2x6x100	220	4,90	5	012020018
2x6x150	270	5,35	5	012020021
3x8x150	282	6,70	3	012020024
4x9,5x200	332	9,15	3	012020027



1202/S4	€	🔧	📦
PH0x3x60-PH1x4,5x120 PH2x6x150-PH3x8x150 mm	18,80	1	012020204

1202N

giravite per viti con impronta a croce Phillips® tipo cortissimo



UNI/ISO 8764 DIN 5262

PHxDxL mm	L1 mm	€	🔧	📦
1x4,5x30	86,5	3,80	3	012020103
2x6x30	86,5	4,00	3	012020106

1203/D

serie giravite

Beta EASY



1203/D5	€	🔧	📦
	21,30	1	012030001

1201	0,6x3,5x100-1,0x5,5x150 1,2x6,5x150 mm
1202	PH1x4,5x80-PH2x6x100 mm



1203/D7	€	🔧	📦
	26,50	1	012030007

1201	0,5x3x75-0,8x4x100 1,0x5,5x100-1,2x6,5x150 mm
1202	PH0x3x60-PH1x4,5x80 PH2x6x100 mm



1203/D8	€	🔧	📦
	34,00	1	012030008

1201	0,5x3x75-0,8x4x125 1,0x5,5x150-1,2x6,5x150 mm
1202	PH0x3x60-PH1x4,5x80 PH2x6x100-PH3x8x150 mm



1203/D10	€	🔧	📦
	42,50	1	012030010

1201	0,4x2,5x50-0,5x3x75 0,8x4x100-1,0x5,5x100 1,2x6,5x150-1,2x8x150 mm
1202	PH0x3x60-PH1x4,5x80 PH2x6x100-PH3x8x150 mm



1203/D6	€	🔧	📦
	21,60	1	012030006

1202	PH1x4,5x80-PH2x6x100 mm
1204	0,4x2,5x60-0,5x3x100 0,8x4x100-1,0x5x125 mm



1203/D5PZ	€	🔧	📦
	20,90	1	012030003

1201	0,5x3x75-0,8x4x125 1,0x5,5x150 mm
1209PZ	PZ1x4,5x80-PZ2x6x100 mm

1203/S10

Beta EASY



1203/S10	€	🔧	📦
	43,00	1	012030021

1201	0,4x2,5x50-0,5x3x75 0,8x4x125-1,0x5,5x150 1,2x6,5x150-1,2x8x150 mm
1202	PH0x3x60-PH1x4,5x80 PH2x6x100-PH3x8x150 mm

1204

giravite per viti senza testa con intaglio



SxDxL mm	L1 mm	€	🔧	📦
0,4x2,5x60	156	2,70	5	012040003
0,5x3x100	196	2,90	5	012040009
0,8x4x100	196	3,30	5	012040012
1x5x125	234	4,00	5	012040018
1,2x6,5x150	270	4,70	5	012040024



1204/S5	€	🔧	📦
0,4x2,5x60-0,5x3x100 0,8x4x100-1x5x125 1,2x6,5x150 mm	17,60	1	012040205

1207TX

chiavi maschio con impugnatura per viti con impronta Torx®



	L mm	L1 mm	∅ mm	€	🔧	📦
T6	60	156	4	5,05	5	012070006
T7	60	156	4	5,10	5	012070007
T8	60	156	4	5,20	5	012070008
T9	60	156	4	5,40	5	012070009
T10	80	189	5	5,65	5	012070010
T15	80	189	5	5,75	5	012070015
T20	100	209	5	5,85	5	012070020
T25	100	209	5	6,10	5	012070025
T27	100	220	6	6,20	5	012070027
T30	100	220	6	6,60	5	012070030
T40	130	262	7	7,10	2	012070040
T45	130	262	8	8,20	2	012070045



1207TX/D7	€	🔧	📦
T6-T8-T10-T15 T20-T25-T30	40,00	1	012070207

Beta

1208RTX

chiavi maschio con impugnatura per viti con impronta Tamper Resistant Torx®



Ø	L	L1	Ø	€	5	1
mm	mm	mm	mm			
T9	60	156	4	5,50	5	012080009
T10	80	189	5	5,80	5	012080010
T15	80	189	5	6,15	5	012080015
T20	100	209	5	6,25	5	012080020
T25	100	209	5	6,35	5	012080025
T27	100	220	6	6,75	5	012080027
T30	100	220	6	7,10	5	012080030
T40	130	262	7	7,80	2	012080040



1208RTX/D7
T9-T10-T15-T20
T25-T27-T30
€ 44,00 1 012080207

1209PZ

giravite per viti con impronta a croce Pozidriv®-Supadriv®



UNI/ISO 8764

PZ	L	L1	€	5	1
	mm	mm			
0	60	156	3,35	5	012090000
1	80	189	4,35	5	012090003
2	100	220	5,75	5	012090006
3	150	282	8,80	3	012090009



1209PZ/S4
PZ0-PZ1-PZ2-PZ3
€ 22,30 1 012090204

1229LP

microgiravite per viti senza testa con intaglio

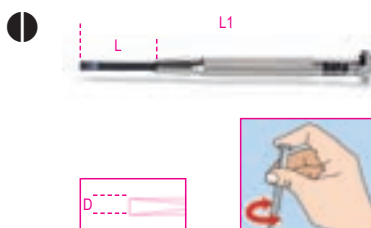

D	L	L1	€	5	1
mm	mm	mm			
1,0	17	75	3,20	5	012290210
1,2	21	85	3,20	5	012290212
1,4	21	89	3,20	5	012290214
1,8	23	94	3,20	5	012290218
2,0	23	98	3,20	5	012290220
2,4	26	103	3,20	5	012290224
3,0	28	108	3,90	5	012290230



1229LP/A6
1,2-1,4-1,8-2-2,4-3 mm
€ 18,00 1 012290300

1229PH

microgiravite per viti con impronta a croce Phillips®

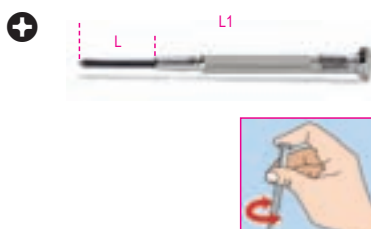

PH	L	L1	€	5	1
	mm	mm			
0	26	102	3,60	5	012290250
1	29	107	3,80	5	012290251

1229LPH/A6

serie di 6 microgiravite
1229LP - 1229PH



1229LPH/A6
1229LP 1,4-2,0-2,4-3
1229PH 0-1
€ 18,00 1 012290310

1236B

giravite a squadra per viti a testa con intaglio

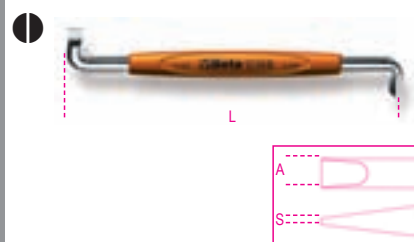

UNI 7079 DIN 5200

SxA	L	€	5	1
mm	mm			
0,8x4	100	5,30	5	012360201
1x5,5	125	5,90	5	012360202
1,2x8	150	8,00	5	012360204

1238B

giravite a squadra per viti con impronta a croce Phillips®



UNI 7083 DIN 5208

PH	L	€	5	1
	mm			
1-2	125	5,90	5	012380201
3-4	200	11,00	5	012380203

1241

giravite a battere per viti a testa con intaglio

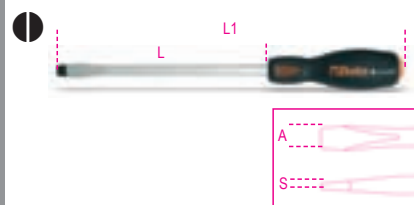

SxAxL	L1	€	5	1
mm	mm			
1x5,5x100	202	7,70	5	012410039
1,2x6,5x125	240	8,90	5	012410050
1,2x8x150	248	10,70	3	012410057
1,6x10x200	325	13,00	2	012410066

1242

giravite a battere per viti con impronta a croce Phillips®



UNI/ISO 8764 DIN 5262

PHxDxL	L1	€	5	1
mm	mm			
1x4,5x100	202	7,80	5	012420209
2x6x100	215	9,00	5	012420218
3x8x150	248	12,00	3	012420221
4x11x200	325	15,60	2	012420224



1243/D7

serie giravite a battere



1243/D7 € 69,00 1 012430017

1241	1x5,5x100-1,2x6,5x125 1,2x8x150-1,6x10x200 mm
1242	PH1x4,5x100-PH2x6x100 PH3x8x150 mm

1250

giravite prensili per viti a testa con intaglio



SxDxL mm	L1 mm	€	5	012500030
0,5x3x125	190	11,50	5	012500030
0,6x4x125	225	13,50	5	012500040
0,7x5x150	255	16,00	5	012500050

1251

giravite prensili per viti con impronta a croce Phillips®



PhxDxL mm	L1 mm	€	5	012510000
0x4x125	225	14,00	5	012510000
1x5x150	255	16,50	5	012510010
2x6x175	280	19,00	5	012510020

1252/S5



1252/S5 € 76,50 1 012520001

1250	0,5x3x125-0,6x4x125 0,7x5x150 mm
1251	PH1x5x150-PH2x6x175 mm

1253

giravite cercafase 150/250V



SxAxL mm	L1 mm	€	5	012530001
0,5x3,5x100	190	5,50	5	012530001

1253A

giravite cercafase 125/250V doppio isolamento



SxAxL mm	L1 mm	€	5	012530010
0,5x3x15	150	5,00	5	012530010

1254

giravite provacircuito 6÷24V



SxAxL mm	L1 mm	€	5	012540001
0,5x3x44	123	6,50	5	012540001

1256/C36-2

microgiravite con 36 inserti intercambiabili da 4 mm e prolunga magnetica



1256/C36-2 € 48,00 1 012560100

	1256TX	T3 - T4 - T5 - T6 - T7 T8 - T9 - T10 - T15
	1256RTX	T6 - T7 - T8 - T9 - T10
	1256LP	0,8 - 1,2 - 1,5 - 1,8 - 2 - 2,5 3 - 3,5 - 4 mm
	1256PE	0,7 - 0,9 - 1,3 - 1,5 - 2 mm
	1256PH	PH000 - PH00 - PH0 - PH1
	1256PZ	PZ000 - PZ00 - PZ0 - PZ1
	1256/20	
	1256/30	

130x60x35 mm - 200 g

1256LP

inserti 4 mm per viti a testa con intaglio



SxA mm	L mm	€	5	012560001
0,25x0,8	27	0,85	5	012560001
0,25x1,2	27	0,85	5	012560002
0,3x1,5	27	0,85	5	012560003
0,35x1,8	27	0,85	5	012560004
0,4x2,0	27	0,85	5	012560005
0,4x2,5	27	0,85	5	012560006
0,5x3,0	27	0,85	5	012560007
0,6x3,5	27	0,85	5	012560008
0,8x4,0	27	0,85	5	012560009

1256PH

inserti 4 mm per viti con impronta Phillips®



PH	L mm	€	5	012560011
000	27	0,80	5	012560011
00	27	0,80	5	012560012
0	27	0,80	5	012560013
1	27	0,80	5	012560014

1256PZ

inserti 4 mm per viti con impronta Pozidriv®



PZ	L mm	€	5	012560061
000	27	0,80	5	012560061
00	27	0,80	5	012560062
0	27	0,80	5	012560063
1	27	0,80	5	012560064

1256PE

inserti 4 mm per viti con impronta esagonale



mm	L mm	€	5	012560021
0,7	27	0,90	5	012560021
0,9	27	0,90	5	012560022
1,3	27	0,90	5	012560023
1,5	27	0,90	5	012560024
2,0	27	0,90	5	012560025

1256TX

inserti 4 mm
per viti con impronta Torx®



Ø	L mm	€	5	10
T3	27	0,95	5	012560041
T4	27	0,95	5	012560042
T5	27	0,95	5	012560043
T6	27	0,95	5	012560044
T7	27	0,95	5	012560045
T8	27	0,95	5	012560046
T9	27	0,95	5	012560047
T10	27	0,95	5	012560048
T15	27	0,95	5	012560049

1256RTX

inserti 4 mm
per viti con impronta Tamper Resistant Torx®



Ø	L mm	€	5	10
T6	27	1,10	5	012560051
T7	27	1,10	5	012560052
T8	27	1,10	5	012560053
T9	27	1,10	5	012560054
T10	27	1,10	5	012560055

1256/20

prolunga con attacchi esagonali
maschio e femmina da 4 mm



1256/20	€	5	012560092
	5,00		

1256/30

portainseri da 4 mm con impugnatura



L mm	€	2	012560097
110	7,00		

1257LP

microgiravite per viti senza testa
con intaglio



SxD mm	L mm	€	5	10
0,2x1,2	60	3,60	5	012570012
0,25x1,5	60	3,60	5	012570015
0,3x1,8	60	3,60	5	012570018
0,4x2	60	3,60	5	012570020
0,4x2,5	60	3,60	5	012570024
0,5x3	60	3,60	5	012570030
0,6x3,5	60	3,60	5	012570035
0,8x4	60	3,60	5	012570040



1257LP/S8	€	1	012570100
	51,00		
0,2x1,2-0,25x1,5			
0,3x1,8-0,4x2-0,4x2,5			
0,5x3-0,6x3,5-0,8x4 mm			

1257PH

microgiravite per viti
con impronta a croce Phillips®



PH	L mm	€	5	10
00	60	3,60	5	012570060
0	60	3,60	5	012570063
1	60	3,60	5	012570066

1257LPH/S8



1257LPH/S8	€	1	012570110
	51,00		
1257PH	PH00-PH0-PH1		
1257LP	0,4x2-0,4x2,5-0,5x3		
	0,6x3,5-0,8x4 mm		

1257ES

microgiravite a chiave maschio
esagonale



mm	L mm	€	5	10
0,9	60	4,00	5	012570045
1,3	60	4,00	5	012570046
1,5	60	4,00	5	012570047
2	60	4,00	5	012570048
2,5	60	4,00	5	012570049
3	60	4,00	5	012570050

1257ESB/S8



1257ESB/S8	€	1	012570130
	56,50		
1257ES	0,9-1,3-1,5-2-2,5-3 mm		
1257BE	4-5 mm		

1257TX

microgiravite a chiave maschio
per viti con impronta Torx®



Ø	L mm	€	5	10
T5	60	4,20	5	012570075
T6	60	4,20	5	012570076
T7	60	4,20	5	012570077
T8	60	4,20	5	012570078
T9	60	4,20	5	012570079
T10	60	4,20	5	012570080
T15	60	4,20	5	012570081
T20	60	4,20	5	012570082



1257TX/S8	€	1	012570120
	55,50		
T5-T6-T7-T8			
T9-T10-T15-T20			

1257BE

microgiravite
chiave bussola esagonale



mm	L mm	€	5	10
3,2	60	5,20	5	012570085
4	60	5,20	5	012570086
5	60	5,20	5	012570087
5,5	60	5,20	5	012570088

1260

giravite per viti a testa con intaglio



ISO 2380

SxAxL mm	L1 mm	Ø mm	€	🔧	📦
0,4x2,5x50	150	2,5	3,90	5	012600003
0,4x2,5x75	175	2,5	4,00	5	012600006
0,5x3x75	175	3,0	4,10	5	012600009
0,5x3x100	200	3,0	4,20	5	012600012
0,6x3,5x75	175	3,5	4,30	5	012600018
0,6x3,5x100	200	3,5	4,40	5	012600021
0,8x4x100	208	4,0	4,70	5	012600030
0,8x4x125	233	4,0	4,90	5	012600033
0,8x4x150	258	4,0	5,00	5	012600036
1x5,5x100	208	5,0	5,35	5	012600039
1x5,5x125	233	5,0	5,45	5	012600040
1x5,5x150	258	5,0	6,10	5	012600042
1,2x6,5x100	219	6,0	6,60	5	012600048
1,2x6,5x125	244	6,0	6,80	5	012600050
1,2x6,5x150	269	6,0	7,00	5	012600051
1,2x8x150	277	8,0	8,50	3	012600057
1,2x8x200	327	8,0	9,05	3	012600060
1,6x10x200	327	9,5	10,90	3	012600066
2x12x250	377	10	12,90	3	012600069



1260/S6 € 35,00 1 012600306

0,4x2,5x75-0,5x3x75-0,8x4x125
1x5,5x150-1,2x6,5x150-1,2x8x200 mm

1260N

giravite per viti a testa con intaglio
tipo cortissimo



ISO 2380

SxAxL mm	L1 mm	Ø mm	€	🔧	📦
0,8x4x30	87	4	5,15	5	012600103
1,2x6,5x30	87	6	5,55	5	012600106



1260E

giravite con esagono di manovra
per viti a testa con intaglio

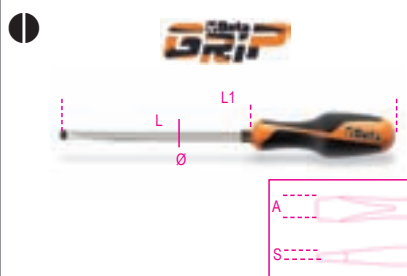

SxAxL mm	L1 mm	Ø mm	€	🔧	📦
1,2x6,5x150	269	6,0	9,25	3	012600156
1,2x8x175	301	8,0	11,40	3	012600157
1,6x10x200	327	9,5	13,40	2	012600159
2x12x250	377	9,5	15,40	2	012600162

1262

giravite per viti
con impronta a croce Phillips®



UNI/ISO 8764 DIN 5262

PHxDxL mm	L1 mm	€	🔧	📦
0x3x60	160	4,00	5	012620003
0x3x100	200	4,30	5	012620006
1x4,5x80	188	5,35	5	012620009
1x4,5x120	228	5,75	5	012620012
2x6x100	219	6,60	5	012620018
2x6x150	269	7,20	5	012620021
3x8x150	277	9,75	3	012620024
4x10x200	327	12,40	3	012620027



1262/S4 € 25,50 1 012620304

PH0x3x60-PH1x4,5x80
PH2x6x100-PH3x8x150 mm

1262N

giravite per viti con impronta
a croce Phillips®
tipo cortissimo



UNI/ISO 8764 DIN 5262

PHxDxL mm	L1 mm	€	🔧	📦
1x4,5x30	87	5,15	5	012620103
2x6x30	87	5,55	5	012620106

1262E

giravite con esagono di manovra
per viti con impronta a croce Phillips®



UNI/ISO 8764

PHxDxL mm	L1 mm	€	🔧	📦
2x6x150	269	9,25	3	012620153
3x8x175	302	11,40	3	012620156
4x10x200	327	13,40	2	012620159

1262L

giravite per viti con impronta
a croce Phillips®, tipo lungo



UNI/ISO 8764-1

PHxDxL mm	L1 mm	€	🔧	📦
0x3x300	400	7,20	3	012620203
1x4,5x400	508	9,75	3	012620206
2x6x400	519	12,90	3	012620209

1263/D...

serie giravite



1263/D5 € 26,00 1 012630005

1260 0,5x3x75-0,8x4x100
1x5,5x125 mm
1262 PH1x4,5x80-PH2x6x100 mm

1263/D6 € 33,00 1 012630006

1260 0,5x3x75-0,8x4x100
1x5,5x125-1,2x6,5x150 mm
1262 PH1x4,5x80-PH2x6x100 mm

1263/D7 € 34,50 1 012630017

1262 PH0x3x60-PH1x4,5x80
PH2x6x100 mm
1264 0,5x2,5x60-0,6x3x100
0,8x4x125-1x5x125 mm

	1263/D7PZ	€ 40,00		1	012630007
1260	0,5x3x75-0,8x4x100 1x5,5x150-1,2x6,5x150 mm				
1269PZ	PZ0 - PZ1 - PZ2				

	1263/D8	€ 41,00		1	012630008
1260	0,4x2,5x50-0,5x3x75 0,8x4x100-1x5,5x125 1,2x6,5x150 mm				
1262	PH0x3x60-PH1x4,5x80 PH2x6x100 mm				

	1263/D10	€ 52,50		1	012630010
1260	0,5x3x75-0,6x3,5x100 0,8x4x125-1x5,5x150 1,2x6,5x150 mm				
1260N	0,8x4x30				
1262	PH0x3x60-PH1x4,5x80 PH2x6x100 mm				
1262N	PH1x4,5x30				

1263/S12

serie di 12 giravite



	1263/S12	€ 75,50		1	012630112
1260	0,4x2,5x50-0,5x3x75 0,6x3,5x100-0,8x4x125 1x5,5x125-1,2x6,5x150 1,2x8x200-1,6x10x200 mm				
1262	PH0x3x60-PH1x4,5x80 PH2x6x100-PH3x8x150 mm				

1264

giravite per viti senza testa
con intaglio



SxDxL mm	L1 mm	€			
0,5x2,5x60	160	3,90		5	012640003
0,6x3x75	175	4,10		5	012640006
0,6x3x100	200	4,20		5	012640009
0,8x4x100	208	4,80		5	012640012
0,8x4x125	233	5,00		5	012640015
1x5x125	233	5,50		5	012640018
1x5x150	258	6,10		5	012640021
1,2x6,5x150	269	7,00		5	012640024



	1264/S5	€ 25,50		1	012640305
	0,5x2,5x60-0,6x3x75 0,8x4x100-1x5x125-1,2x6,5x150 mm				

1264L

giravite per viti senza testa con intaglio
tipo lungo



SxDxL mm	L1 mm	€			
0,5x2,5x200	300	5,65		3	012640203
0,6x3x300	400	6,70		3	012640206
0,8x4x400	508	8,75		3	012640209
1x5x400	508	9,75		3	012640215
1,2x6,5x400	519	11,90		3	012640218

1265ES

chiavi maschio esagonale
con impugnatura



mm	L mm	L1 mm	€		
1,5	100	200	4,60		3 012650015
2	100	200	4,80		3 012650020
2,5	100	200	5,00		3 012650025
3	100	200	5,25		3 012650030
4	100	208	5,65		3 012650040
5	100	219	6,70		3 012650050
6	125	244	7,70		3 012650060
8	150	277	9,75		2 012650080



	1265ES/S8	€ 49,50		1	012650308
	1,5-2-2,5-3-4-5-6-8 mm				

1266BP

chiavi maschio esagonale
ad estremità sferica con impugnatura



mm	L mm	L1 mm	€		
2	100	200	5,15		3 012660020
2,5	100	200	5,35		3 012660025
3	125	225	5,55		3 012660030
4	125	233	6,20		3 012660040
5	120	239	7,10		3 012660050
6	140	259	8,20		3 012660060
8	160	287	10,40		2 012660080
10	160	287	12,40		2 012660100



	1266BP/S8	€ 60,50		1	012660308
	2-2,5-3-4-5-6-8-10 mm				

1267TX

chiavi maschio con impugnatura
per viti con impronta Torx®



mm	L mm	L1 mm	Ø mm	€		
T5	50	150	3	6,15		5 012670005
T6	50	150	3	6,35		5 012670006
T7	50	150	3	6,55		5 012670007
T8	60	160	3	6,85		5 012670008
T9	60	167	4	7,20		5 012670009
T10	80	188	4	7,50		5 012670010
T15	80	188	4	7,90		5 012670015
T20	100	208	4,5	8,30		5 012670020
T25	100	208	5	8,75		5 012670025
T27	115	234	6	9,15		5 012670027
T30	115	234	6	9,60		5 012670030
T40	130	257	7	10,30		2 012670040
T45	130	257	8	11,90		2 012670045



	1267TX/D7	€ 55,00		1	012670307
	T6-T8-T10-T15 T20-T25-T30				





1267TX/S13
T5-T6-T7-T8-T9
T10-T15-T20-T25
T27-T30-T40-T45

€ 106,50 1 012670312

1268RTX

chiavi maschio con impugnatura per viti con impronta Tamper Resistant Torx®



⊕	L mm	L1 mm	Ø mm	€	📦	📄
T9	60	167	4,0	7,70	3	012680009
T10	80	188	4,0	8,00	3	012680010
T15	80	188	4,0	8,40	3	012680015
T20	100	208	4,5	8,85	3	012680020
T25	100	208	5,0	9,15	3	012680025
T27	115	234	6,0	9,60	3	012680027
T30	115	234	6,0	9,95	3	012680030
T40	130	257	7,0	10,90	2	012680040



1268RTX/S8
T9-T10-T15-T20
T25-T27-T30-T40

€ 72,50 1 012680307

1269PZ

giravite per viti con impronta a croce Pozidriv®-Supadriv®



UNI/ISO 8764

PZ	L mm	L1 mm	€	📦	📄
0	60	160	4,60	5	012690000
1	80	188	5,95	5	012690001
2	100	219	7,40	5	012690002
3	150	277	10,40	3	012690003
4	200	327	13,40	3	012690004



1269PZ/S4
PZ0-PZ1-PZ2-PZ3

€ 28,50 1 012690304

1269N/PZ

giravite per viti con impronta a croce Pozidriv®-Supadriv® tipo cortissimo



UNI/ISO 8764

PZ	L mm	L1 mm	€	📦	📄
1	30	87	5,15	5	012690011
2	30	87	5,55	5	012690012

1281BG

impugnatura porta lame giravite



L mm 118
mm 10
€ 7,50 5 012810280

1281PM

portainseri magnetico ad innesto rapido



L mm 165
€ 16,00 5 012810292

1281PB

portabussole quadro maschio 1/4"



L mm 175
€ 12,50 5 012810293

1281LP

giravite bivalenti per viti a testa con intaglio



1281LP/1	€	📦	📄
0,8x4-1,2x6,5 mm	8,00	5	012810302
1281LP/2	8,00	5	012810304
1x5,5-1,2x6,5 mm			

1281PH

giravite bivalenti per viti con impronta a croce Phillips®



PH 1-2 € 8,00 5 012810310
2-3 € 8,00 5 012810312

1281LPH

giravite bivalenti per viti a testa con intaglio e Phillips®



1281LPH/1	€	📦	📄
PH0-0,8X4 mm	8,00	5	012810321
1281LPH/2	8,00	5	012810322
PH1-1x5,5 mm			
1281LPH/3	8,00	5	012810323
PH2-1,2x6,5 mm			

1281PZ

giravite bivalenti per viti con impronta a croce Pozidriv®-Supadriv®



PZ 1-2 € 8,00 5 012810330
2-3 € 8,00 5 012810332

1281PE

chiavi maschio esagonale bivalenti con un'estremità sferica



mm	€	📦	📄
2,5	8,00	5	012810342
3	8,00	5	012810343
4	8,00	5	012810344
5	8,00	5	012810345
6	8,00	5	012810346

1281TX

chiavi maschio bivalenti per viti con impronta Torx®



1281TX/1	€	📦	📄
T6-T8	8,50	5	012810349
1281TX/2	8,50	5	012810350
T7-T9			
1281TX/3	8,50	5	012810351
T10-T15			
1281TX/4	8,50	5	012810352
T20-T25			
1281TX/5	8,50	5	012810353
T30-T40			

1281RTX

chiavi maschio bivalenti
per viti con impronta Tamper Resistant Torx®



1281RTX/3 T10-T15	€ 8,50	5	012810361
1281RTX/4 T20-T25	€ 8,50	5	012810362
1281RTX/5 T30-T40	€ 8,50	5	012810363

1281BG/A9

assortimento di 9 giravite bivalenti
e 1 impugnatura, in astuccio

1/4"



1281BG/A9 € 90,50 1 012810520

1281BG	
1281LPH/1	PH0-0,8x4 mm
1281LPH/2	PH1-1x5,5 mm
1281LPH/3	PH2-1,2x6,5 mm
1281PZ/1	PZ1-PZ2
1281PE	2,5 mm
1281PE	3 mm
1281PE	4 mm
1281PE	5 mm
1281PE	6 mm

1281BG-TX/A8

assortimento di 8 giravite bivalenti
e 1 impugnatura, in astuccio

1/4"



1281BG-TX/A8 € 85,00 1 012810530

1281BG	
1281LPH/1	PH0-0,8x4 mm
1281LPH/2	PH1-1x5,5 mm
1281LPH/3	PH2-1,2x6,5 mm
1281TX/1	T6-T8
1281TX/2	T7-T9
1281TX/3	T10-T15
1281TX/4	T20-T25
1281TX/5	T30-T40

1281BG/B28A

assortimento di 16 giravite bivalenti, 9 chiavi a
bussola 1/4", 2 accessori e 1 impugnatura di
manovra, in busta

1/4"



1281BG/B28A € 202,00 1 012810510

900	4 - 4,5 - 5 - 5,5 6 - 7 - 8 - 9 - 10 mm
1281BG	
1281PB	1/4"
900/25	
1281LP/1	0,8x4 - 1,2x6,5 mm
1281LP/2	1,0x5,5 - 1,2x6,5 mm
1281PH/1	PH1 - PH2
1281PH/2	PH2 - PH3
1281PZ/1	PZ1 - PZ2
1281PZ/2	PZ2 - PZ3
1281PE	2,5 - 3 - 4 - 5 - 6 mm
1281TX/1	T6 - T8
1281TX/2	T7 - T9
1281RTX/3	T10 - T15
1281RTX/4	T20 - T25
1281RTX/5	T30 - T40

1281BV € 10,00 1 012810501

1290

giravite per viti a testa con intaglio

ISO 2380



ISO 2380

SxAxL mm	L1 mm	Ø mm	€		
0,4x2,5x50	146	2,5	4,80	5	012900003
0,4x2,5x75	171	2,5	4,90	5	012900006
0,5x3x75	171	3,0	5,00	10	012900009
0,5x3x100	196	3,0	5,20	10	012900012
0,6x3,5x75	171	3,5	5,75	10	012900018
0,6x3,5x100	196	3,5	5,85	10	012900021
0,8x4x100	196	4,0	5,80	10	012900030
0,8x4x125	221	4,0	6,10	10	012900033
0,8x4x150	246	4,0	6,40	10	012900036
1x5,5x100	209	5,0	6,60	10	012900039
1x5,5x150	259	5,0	7,45	10	012900042
1,2x6,5x100	220	6,0	8,10	10	012900048
1,2x6,5x150	270	6,0	8,75	10	012900051
1,2x8x150	282	7,0	10,90	3	012900057
1,2x8x200	332	7,0	11,60	3	012900060
1,6x10x200	332	8,0	13,80	3	012900066
2x12x250	382	10	18,40	2	012900069

Beta

1290/S...

serie giravite



1290/S5 € 38,00 1 012900305

1290 0,5x3x75-0,8x4x100 -1x5,5x150
1,2x6,5x150 -1,2x8x150 mm

1290/S9X € 71,50 1 012900319

1290 0,4x2,5x75 - 0,5x3,5x100
0,8x4x125 - 1x5,5x150
1,2x6,5x150 - 1,2x8x200
1,6x10x200 mm
1290N 0,8x4x30 -1,2x6,5x30 mm

1290N

giravite per viti a testa con intaglio
tipo cortissimo



ISO 2380

SxAxL mm	L1 mm	Ø mm	€		
0,8x4x30	86	4	6,30	5	012900103
1,2x6,5x30	86	6	7,00	5	012900106

1292

giravite per viti
con impronta a croce Phillips®

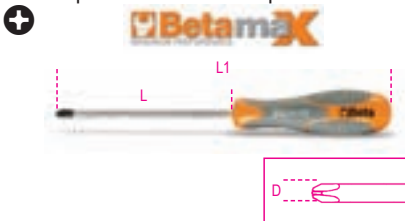

UNI/ISO 8764 DIN 5262

PhxDxL mm	L1 mm	€		
0x3x60	156	4,65	10	012920003
0x3x100	196	5,20	5	012920006
1x4,5x80	189	6,40	10	012920009
1x4,5x120	229	7,00	10	012920012
2x6x100	220	8,50	10	012920018
2x6x150	270	9,25	10	012920021
3x8x150	282	11,60	3	012920024
4x10x200	332	16,40	3	012920027



1292/S4 € 31,00 1 012920304
 PH0x3x60-PH1x4,5x80
 PH2x6x100-PH3x8x150 mm

1292N

giravite per viti con impronta a croce Phillips® tipo cortissimo



UNI/ISO 8764 DIN 5262

PHxDxL mm	L1 mm	€	Icon	Code
1x4,5x30	86	6,00	5	012920103
2x6x30	86	6,65	5	012920106

1292L

giravite per viti con impronta a croce Phillips®, tipo lungo

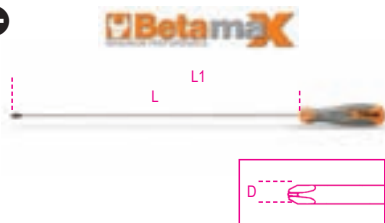

UNI/ISO 8764-1

PHxDxL mm	L1 mm	€	Icon	Code
0x3x300	396	9,80	3	012920203
1x4,5x400	509	12,60	3	012920206
2x6x400	520	15,90	3	012920209

1293/D...

serie giravite



1293/D6 € 41,50 1 012930401

1290 0,6x3,5x75-1x5,5x150
 1,2x6,5x150 mm
 1292 PH0x3x60 -PH1x4,5x80
 PH2x6x100 mm



1293/D8 € 57,50 1 012930403
 1290 0,5x3x75-0,8x4x100
 1x5,5x150-1,2x6,5x150
 1,2x8x150 mm
 1292 PH0x3x60 -PH1x4,5x80
 PH2x6x100 mm

1293/S...

serie giravite



1293/S10 € 82,00 1 012930201

1290 0,4x2,5x50-0,6x3,5x100
 1x5,5x100-1,2x6,5x150
 1,2x8x150-1,6x10x200 mm
 1292 0,8x4x30 mm
 PH0x3x60 -PH1x4,5x80
 PH2x6x100-PH3x8x150 mm



1293/S12 € 89,00 1 012930203

1290 0,5x3x75-0,8x4x125
 1x5,5x150-1,2x6,5x150
 1,2x8x200 mm
 1290N 0,8x4x30 mm
 1292 PH0x3x60 -PH1x4,5x80
 PH2x6x100-PH3x8x150 mm
 1292N PH1x4,5x30-PH2x6x30 mm



1293/S7 € 41,50 1 012930207

1292 PH0x3x60 -PH1x4,5x80
 PH2x6x100 mm
 1294 0,5x2,5x60-0,6x3x75
 0,8x4x100-1x5x125 mm

1293ES

chiavi maschio esagonale con impugnatura



mm	L mm	L1 mm	Ø mm	€	Icon	Code
2	100	196	3	6,45	5	012930001
2,5	100	196	4	6,45	5	012930002
3	100	196	4	6,70	5	012930003
4	100	196	5	7,40	5	012930004
5	100	209	6	8,00	5	012930005
6	125	245	7	9,60	5	012930006
8	150	282	10	12,00	2	012930008



1293ES/S7 € 56,50 1 012930057
 2-2,5-3-4-5-6-8 mm



1293BP

chiavi maschio esagonale ad estremità sferica con impugnatura



mm	L mm	L1 mm	€	Icon	Code
2	100	196	6,50	5	012930501
2,5	100	196	6,50	5	012930502
3	100	196	6,80	5	012930503
4	100	196	7,50	5	012930506
5	100	209	8,20	5	012930509
6	125	245	9,80	5	012930512
8	150	282	12,50	2	012930515



1293BP/S7 € 58,00 1 012930558
 2-2,5-3-4-5-6-8 mm

1294

giravite per viti senza testa con intaglio

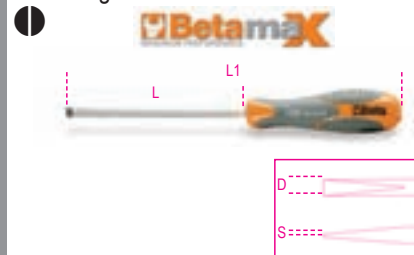

SxDxL mm	L1 mm	€	Icon	Code
0,5x2,5x60	156	4,40	5	012940003
0,6x3x75	171	4,60	5	012940006
0,6x3x100	196	4,85	5	012940009
0,8x4x100	196	5,85	5	012940012
0,8x4x150	246	6,90	5	012940015
1x5x125	234	7,15	5	012940018
1,2x6,5x150	282	8,45	5	012940027



1294/S5 € 30,50 1 012940305
 0,5x2,5x60-0,6x3x100
 0,8x4x100-1x5x125
 1,2x6,5x150 mm

1294L

giravite per viti senza testa con intaglio tipo lungo



SxDxL mm	L1 mm	€	Icon	Icon	Code
0,6x3x300	396	8,80	Icon	Icon	3 012940206
0,8x4x400	496	11,30	Icon	Icon	3 012940209
1x5x400	509	14,20	Icon	Icon	3 012940215
1,2x6,5x400	532	14,80	Icon	Icon	3 012940218

1295

giravite a percussione

12^{pp}



L mm	€	Icon	Icon	Code
130	44,00	Icon	Icon	1 012950001

1295/C14

giravite a percussione con 14 inserti e bussola portainseriti



1295/C14	€	Icon	Icon	Code
	108,50	Icon	Icon	1 012950108

	866LP	1,2x6,5 - 1,6x10 mm
	866PH	PH2 - PH3
	866PZ	PZ2 - PZ3
	866PE	5 - 6 mm
	866TX	T27 - T30 - T40 - T45 - T50 - T55
	895/6	□ 1/2 - □ 5/16
	1295	■ 1/2

170x100x35 mm - 1,3 kg

1297TX

chiavi maschio con impugnatura per viti con impronta Torx®



Icon	L mm	L1 mm	Ø mm	€	Icon	Icon	Code
Icon	T6	50	146	3,0	9,00	Icon	5 012970006
Icon	T7	50	146	3,0	9,15	Icon	5 012970007
Icon	T8	60	156	3,0	9,25	Icon	5 012970008

Icon	L mm	L1 mm	Ø mm	€	Icon	Icon	Code
Icon	T9	60	169	4,0	9,80	Icon	5 012970009
Icon	T10	80	189	4,0	10,30	Icon	5 012970010
Icon	T15	80	189	4,0	10,40	Icon	5 012970015
Icon	T20	100	209	4,5	10,70	Icon	5 012970020
Icon	T25	100	209	5,0	11,10	Icon	5 012970025
Icon	T27	115	235	6,0	11,40	Icon	5 012970027
Icon	T30	115	235	6,0	11,90	Icon	5 012970030
Icon	T40	130	262	7,0	12,80	Icon	2 012970040
Icon	T45	130	262	8,0	14,90	Icon	2 012970045



1297TX/S12	€	Icon	Icon	Code
T6-T7-T8-T9-T10 T15-T20-T25-T27 T30-T40-T45	130,50	Icon	Icon	1 012970312



1297TX/D6	€	Icon	Icon	Code
T10-T15-T20 T25-T27-T30	66,00	Icon	Icon	1 012970409

1298RTX

chiavi maschio con impugnatura per viti con impronta Tamper Resistant Torx®



Icon	L mm	L1 mm	Ø mm	€	Icon	Icon	Code
Icon	T9	60	169	4,0	10,70	Icon	5 012980009
Icon	T10	80	189	4,0	10,90	Icon	5 012980010
Icon	T15	80	189	4,0	11,60	Icon	5 012980015
Icon	T20	100	209	4,0	11,70	Icon	5 012980020
Icon	T25	100	209	4,5	11,80	Icon	5 012980025
Icon	T27	115	235	5,5	12,60	Icon	5 012980027
Icon	T30	115	235	6,0	13,10	Icon	5 012980030
Icon	T40	130	262	7,0	13,50	Icon	2 012980040



1298RTX/S8	€	Icon	Icon	Code
T9-T10-T15-T20 T25-T27-T30-T40	96,00	Icon	Icon	1 012980308

1299PZ

giravite per viti con impronta a croce Pozidriv®-Supadriv®



UNI/ISO 8764

PZ	L mm	L1 mm	€	Icon	Icon	Code
0	60	156	6,20	Icon	Icon	5 012990000
1	80	189	7,85	Icon	Icon	5 012990003
2	100	220	10,90	Icon	Icon	5 012990006
3	150	282	16,00	Icon	Icon	2 012990009
4	200	332	22,70	Icon	Icon	2 012990012



1299PZ/S6	€	Icon	Icon	Code
1299PZ PZ0-PZ1-PZ2-PZ3 1299N/PZ PZ1-PZ2	57,50	Icon	Icon	1 012990306

1299N/PZ

giravite per viti con impronta a croce Pozidriv®-Supadriv® tipo cortissimo



UNI/ISO 8764

PZ	L mm	L1 mm	€	Icon	Icon	Code
1	30	86	7,90	Icon	Icon	5 012990021
2	30	86	8,70	Icon	Icon	5 012990024

1302

tasso con impugnatura testa tonda convessa e a penna



g	€	Icon	Icon	Code
770	59,00	Icon	Icon	1 013020001

1303

tasso a virgola



g	€	Icon	Icon	Code
1350	53,00	Icon	Icon	1 013030001

1304

tasso a suola



g 875 € 59,00 1 013040001

1305

tasso curvo



g 1190 € 39,00 1 013050001

1305Z

tasso curvo zigrinato



g 1065 € 46,00 1 013050002

1306

tasso a tacco bombato



g 1040 € 39,00 1 013060001

1307

tasso rettangolare bombato



g 1100 € 69,00 1 013070001

1308

tasso ovoidale



g 1100 € 65,00 1 013080001

1309

tasso a doppia penna



g 460 € 39,00 1 013090001

1310

tasso a rotaia



g 1225 € 44,00 1 013100001

1312

tasso a incudine



g 1220 € 89,00 1 013120001

1313

tasso a tampone

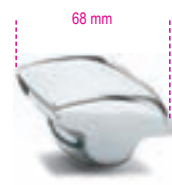

g 990 € 59,00 1 013130001

1314tasso a teste tonde
convessa e piana

g 760 € 39,00 1 013140001

1326

leva a cazzuola



g 560 € 38,00 1 013260001

1327leva a cucchiaio
pesante

g 1075 € 53,50 1 013270001

1328leva a cucchiaio
leggera

g 935 € 49,00 1 013280001

1329

leva curva e piana



g 1800 € 133,00 1 013290001

1330

leva a gomito e piana



g 2125 € 139,00 1 013300001

1331

leva a gola con linguetta in cuoio



410 mm

g 1100 € 85,00 1 013310001

1335BM

battilamiera con impugnatura in materiale plastico



375 mm

g 500 € 25,00 2 013350010

1337/S5

serie di 5 spatoline per carrozzieri in acciaio inox tipo giapponese



L

mm 25-50-75-100-125 € 9,80 1 013370015

1338A - 1338B

portalima con lima a dentatura radiale, piatta flessibile



L

	mm/1"	L mm	€		
1338A	9	360	70,50	2	013380001
1338B	12	360	73,50	2	013380002

1338

portalima per 1338R



1338 € 39,50 2 013380003

1338R9 - 1338R12

lime di ricambio per 1338A e 1338B



	mm/1"	€		
1338R9	9	31,00	2	013380004
1338R12	12	34,00	2	013380005

1342

scalpello extrapiatto con tagliente diritto



L mm 235 € 19,50 5 013420001

1342PM

scalpello extrapiatto con tagliente diritto con paramano



L mm 235 L1 mm 118 € 29,00 2 013420002

1342PMR

paramano di ricambio per 1342



1342PMR € 9,50 1 013420003

1343

scalpello piatto con tagliente laterale



L mm 200 € 21,00 5 013430001

1345

martello con testa tonda convessa e penna manico in legno



1345 € 29,00 3 013450000

1345P

martello con testa tonda piana e penna manico in legno



1345P € 30,00 3 013450001

1351

martello con testa tonda piana e penna sferica manico in legno



1351 € 35,00 3 013510000

1353

martello con testa tonda piana e penna a punta manico in legno

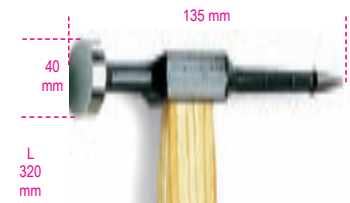

1353 € 31,00 3 013530000

1357/32 - 1357/40

martelli con teste piane tonda e quadra manico in legno

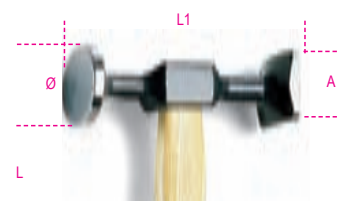

1357/32 € 33,00 3 013570032

Ø = 32 mm
A = 25 mm
L1 = 100 mm
L = 280 mm

1357/40 € 35,00 3 013570040

Ø = 40 mm
A = 35 mm
L1 = 105 mm
L = 290 mm

1357Z/32 - 1357Z/40

martelli con teste piane tonda zigrinata e quadra liscia manico in legno

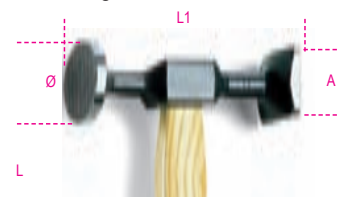

1357Z/32 € 40,00 3 013570132

Ø = 32 mm
A = 25 mm
L1 = 100 mm
L = 280 mm

1357Z/40 € 42,00 3 013570140

Ø = 40 mm
A = 35 mm
L1 = 105 mm
L = 290 mm

1359T

martello con testa tonda piana e penna orizzontale
manico in legno

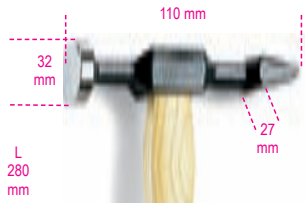

1359T € 29,00 3 013590001

1369/C11X

assortimento di 11 utensili



1369/C11X € 571,00 1 013690023

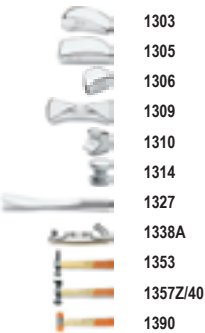

470x340x70 mm - 15,2 kg

1370

martelli tipo tedesco
per meccanici
manico in legno



HICKORY

UNI 7778 DIN 1041

g	A mm	L mm	L1 mm	€		
100	15	260	82	8,50	5	013700051
200	19	280	95	9,50	5	013700052
300	23	300	105	11,00	5	013700053
400	25	310	112	12,50	5	013700054
500	27	320	118	13,50	5	013700055
600	30	330	122	15,50	5	013700056
800	33	350	130	17,50	4	013700058
1000	36	360	135	20,50	4	013700060
1500	42	380	145	24,00	2	013700065
2000	47	400	155	30,00	1	013700070

1370/MR...

manici di ricambio per 1370



	€		
1370/MR100	3,90	4	013700081
1370/MR200	4,30	4	013700082
1370/MR300	4,60	4	013700083
1370/MR400	4,90	4	013700084
1370/MR500	5,40	4	013700085
1370/MR600	6,00	4	013700086
1370/MR800	6,30	4	013700088
1370/MR1000	6,60	4	013700090
1370/MR1500	7,40	4	013700095
1370/MR2000	8,20	4	013700100

1370T

martelli tipo tedesco
per meccanici
manico in fibra



g	A mm	L mm	L1 mm	€		
200	19	280	95	15,00	5	013700620
300	23	300	105	16,50	5	013700630
500	27	320	118	17,50	5	013700650
800	33	350	130	19,00	4	013700680
1000	36	360	135	23,50	4	013700700
1500	42	365	145	30,00	2	013700750

1370F

martelli tipo francese
per meccanici
manico in legno



HICKORY

NF E 71.014

A mm	L mm	L1 mm	€		
24	260	77	15,00	2	013700424
26	260	80	15,50	2	013700426
28	280	86	17,50	2	013700428
30	280	92	18,00	2	013700430
32	300	100	19,50	2	013700432
36	300	104	22,00	2	013700436
40	330	110	26,00	2	013700440
42	330	116	27,00	2	013700442
50	380	138	29,00	2	013700450
60	380	160	32,00	2	013700460

1370F/MR...

manici di ricambio per 1370F



	€		
1370F/MR24	4,00	2	013700474
1370F/MR26			
1370F/MR28	4,20	2	013700478
1370F/MR30			
1370F/MR32	4,80	2	013700482
1370F/MR36			
1370F/MR40	6,20	2	013700490
1370F/MR42			
1370F/MR50	7,00	2	013700495
1370F/MR60	8,50	2	013700496

1370FT

martelli tipo francese per meccanici,
manico in fibra



A mm	L mm	L1 mm	€			
28	280	86	530	26,00	1	013700528
30	280	92	625	26,50	1	013700530
32	300	100	750	28,50	1	013700532
36	300	104	930	32,00	1	013700536
40	330	110	1150	34,00	1	013700540
42	330	116	1250	35,00	1	013700542
50	380	138	2100	37,50	1	013700550
60	380	160	2750	42,50	1	013700560

1374F

martelli tipo francese
per falegnami
manico in legno



HICKORY

NF E 71.012

A mm	L mm	L1 mm	g	€		
16	250	80	176	12,20	2	013740416
20	270	86	247	13,60	2	013740420
22	290	92	334	14,20	2	013740422
26	290	103	425	15,30	2	013740426
28	310	108	513	16,30	2	013740428
30	310	117	576	17,70	2	013740430

1374F/MR...

manici di ricambio per 1374F



	€		
1374F/MR16	3,75	2	013740456
1374F/MR20	3,85	2	013740460
1374F/MR22	3,95	2	013740462
1374F/MR26			
1374F/MR28	4,30	2	013740468
1374F/MR30	4,55	2	013740470

1375

martello con penna
a granchio
manico in legno



g	L1 mm	Ø mm	L mm	€	🔧	📦
300	95	25	300	14,00	3	013750000

1375/MR

manici di ricambio per 1375



1375/MR	€ 5,50	2	013750003
---------	--------	---	-----------

1375A

martelli con penna
a granchio
manico in materiale plastico



oz	g	L mm	L1 mm	€	🔧	📦
16	450	330	130	22,50	3	013750016
20	570	330	130	23,50	3	013750020

1375B

martelli con penna
a granchio
manico in acciaio



oz	g	L mm	L1 mm	€	🔧	📦
16	450	330	130	19,50	3	013750026
20	570	330	130	20,00	3	013750030

1376X

martelli a testa quadra,
con sede portachiodo e calamita,
penna a granchio, per carpentieri
manico in legno



g	A mm	L1 mm	L mm	€	🔧	📦
250	20	125	450	13,00	3	013760125
300	25	130	450	14,00	3	013760130
400	27	132	450	15,00	3	013760140

1376X/MR

manico di ricambio
per 1376X



1376X/MR	€ 8,00	2	013760161
----------	--------	---	-----------

1376XT

martelli a testa quadra,
con sede portachiodo e calamita,
penna a granchio, per carpentieri
manico in materiale plastico



g	A mm	L1 mm	L mm	€	🔧	📦
250	20	125	500	17,00	3	013760525
300	25	130	500	18,00	3	013760530
400	27	132	500	19,00	3	013760540

1376XT/MR

manico di ricambio
per 1376XT



1376XT/MR	€ 8,00	2	013760585
-----------	--------	---	-----------

1377

martelli con testa tonda
e penna sferica
per calderai e lattonieri
manico in legno



HICKORY

g	L mm	L1 mm	€	🔧	📦
340	330	95	20,50	2	013770134
450	350	102	21,50	2	013770145
570	350	110	24,50	2	013770157
680	360	116	25,50	2	013770168
900	380	120	27,00	2	013770190

1377/MR...

manici di ricambio per 1377



1377/MR340 1377/340	€ 4,50	2	013770234
1377/MR450 1377/450	€ 5,50	2	013770245
1377/MR570 1377/570	€ 6,00	2	013770257
1377/MR680 1377/680	€ 6,20	2	013770268
1377/MR900 1377/900	€ 7,00	2	013770290

1378

martelli con testa tonda
e penna simmetrica
per calderai e lattonieri
manico in legno



HICKORY

g	L mm	L1 mm	Ø mm	€	🔧	📦
340	330	100	27	20,00	2	013780134
570	350	115	32	25,00	2	013780157

1378/MR...

manici di ricambio per 1378



1378/MR340 1378/340	€ 4,00	2	013780234
1378/MR570 1378/570	€ 6,00	2	013780257

1379F

martelli tipo francese
per elettricisti
manico in legno



HICKORY

NF E 71.011

A mm	L mm	L1 mm	€	🔧	📦
16	250	126	13,00	2	013790416
18	250	135	14,00	2	013790418
20	260	142	15,00	2	013790420

1379F/MR...

manici di ricambio per 1379F



1379F/MR16 1379F/16-18	€ 4,00	2	013790426
1379F/MR20 1379F/20	€ 4,50	2	013790430

Beta

1380

mazzette
manico in legno



HICKORY

UNI 7777 DIN 6475

g	A mm	L mm	L1 mm	€		
800	38	260	90	15,00	2	013800208
1000	40	260	95	17,00	2	013800210
1250	43	260	100	17,50	2	013800212
1500	45	280	110	19,50	2	013800215
2000	50	300	120	25,00	2	013800220

1380/MR...

manici di ricambio per 1380



	€		
1380/MR800 1380/800-1000-1250	4,80	2	013800238
1380/MR1500 1380/1500	5,00	2	013800245
1380/MR2000 1380/2000	5,50	2	013800250

1380S

mazzette con collare salvamanico
manico in legno
collare in materiale plastico



g	A mm	L mm	L1 mm	€		
800	36	260	90	16,50	2	013800400
1000	39	260	95	19,00	2	013800405
1250	43	260	100	20,00	2	013800410
1500	45	260	110	22,50	2	013800415

1380S/MR...

manici di ricambio per 1380S



	€		
1380S/MR800 1380S/800-1000-1250	5,00	2	013800417
1380S/MR1500 1380S/1500	5,50	2	013800419

1380T

mazzette
manico in fibra



g	A mm	L mm	L1 mm	€		
800	35	260	85	23,00	2	013800308
1000	40	260	100	23,50	2	013800310
1250	42	260	110	25,00	2	013800312
1500	45	260	120	27,50	2	013800315

1381

mazze a coppia
manico in legno hickory

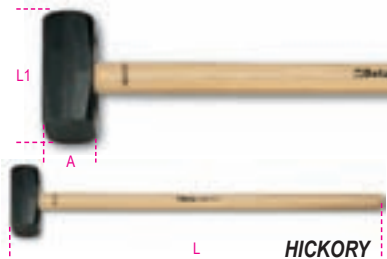

g	A mm	L mm	L1 mm	€		
3000	55	800	142	62,00	1	013810030
4000	60	900	152	68,00	1	013810040
5000	70	900	162	77,00	1	013810050
8000*	80	900	185	122,00	1	013810080

* = manico in frassino

1381/MR...

manici di ricambio per 1381



	€		
1381/MR3-4 1381/3000-4000	25,00	2	013810730
1381/MR5 1381/5000	28,00	2	013810750
1381/MR8 1381/8000	30,00	2	013810780

1381T

mazze a coppia
manico in fibra

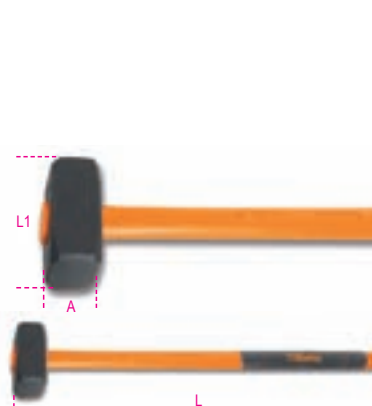

g	A mm	L mm	L1 mm	€		
3000	55	900	142	68,00	1	013810330
4000	60	900	152	75,00	1	013810340
5000	70	900	162	85,00	1	013810350

1385

mazzuole
con testa in rame
manico in legno



g	A mm	L mm	L1 mm	€		
400	26	260	75	23,00	2	013850404
600	32	270	80	33,00	2	013850406
800	34	280	90	42,00	2	013850408
1000	37	280	100	53,00	2	013850410
1500	43	280	110	76,00	2	013850415
2000	48	300	120	99,00	2	013850420

1385/MR

manici di ricambio per 1385



	€		
1385/MR400 1385 400	7,25	2	013850464
1385/MR600 1385 600	7,40	2	013850466
1385/MR800 1385 800	7,55	2	013850468
1385/MR1000 1385 1000	8,20	2	013850470
1385/MR1500 1385 1500	8,80	1	013850475
1385/MR2000 1385 2000	9,15	1	013850480

1390

mazzuole con battenti intercambiabili
in materiale plastico
manico in legno



UNI 7784

D mm	L mm	L1 mm	€		
22	260	70	12,50	5	013900022
28	280	85	15,50	5	013900028
35	310	95	20,50	5	013900035
45	320	107	34,00	4	013900045
60	380	128	57,00	2	013900060

1390/MR...

manici di ricambio per 1390



	€		
1390/MR22 1390/22	3,50	2	013900222
1390/MR28 1390/28	3,80	2	013900228
1390/MR35 1390/35	4,50	2	013900235
1390/MR45 1390/45	4,80	2	013900245
1390/MR60 1390/60	6,60	2	013900260



1390R

battenti di ricambio per 1390



D mm	€	Imp.	Info
22	2,00	4	013900122
28	3,00	4	013900128
35	4,00	4	013900135
45	7,00	4	013900145
60	12,00	4	013900160

1390N

mazzuole con battenti intercambiabili in nylon, manico in legno

Battenti medio-duri: 75 Shore
Resistente all'olio e all'usura

Particolarmente indicato per lavorazioni su lamiera e metalli



D mm	L mm	L1 mm	€	Imp.	Info
22	260	70	13,50	3	013900522
28	280	85	16,50	3	013900528
35	310	95	22,00	3	013900535
45	320	107	36,00	2	013900545
60	380	128	60,00	2	013900560

1390NR

battenti di ricambio in nylon per 1390N



D mm	€	Imp.	Info
22	2,10	4	013900622
28	3,20	4	013900628
35	4,20	4	013900635
45	7,30	4	013900645
60	12,50	4	013900660

1391

mazzuole antirimbalo interamente rivestite in gomma



D mm	L mm	L1 mm	€	Imp.	Info
35	280	90	20,00	2	013910135
50	320	105	26,50	2	013910150
55	355	110	30,00	2	013910155
65	380	130	46,00	2	013910165

1391A

mazzuole per piastrellisti interamente rivestite in gomma



g	D mm	L mm	L1 mm	€	Imp.	Info
500	45	290	100	21,00	2	013910205
1000	60	300	120	27,00	2	013910210

1392

mazzuole antirimbalo con battenti intercambiabili in materiale plastico manico in acciaio



D mm	L mm	L1 mm	€	Imp.	Info
30	300	105	34,50	2	013920030
35	305	115	36,50	2	013920035
40	310	125	41,50	2	013920040
50	325	135	49,50	2	013920050
60	385	155	76,00	2	013920060

1392R

battenti di ricambio per 1392

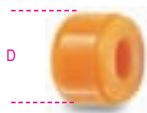

D mm	€	Imp.	Info
30	4,50	4	013920230
35	6,50	4	013920235
40	9,50	4	013920240
50	13,00	4	013920250
60	19,00	4	013920260

1393

mazzuole con testa in gomma dura



D mm	L mm	L1 mm	€	Imp.	Info
50	315	90	9,00	3	013930050
60	340	110	10,00	3	013930060
70	370	130	12,00	2	013930070

1410/M

attrezzo ad uncino per trazione molle



Ø mm	€	Imp.	Info
3,5	13,00	2	014100051

1428

estrattori per dadi danneggiati con attacco quadro



mm	□	L mm	€	Imp.	Info
8	3/8	36	13,50	3	014280008
10	3/8	36	13,50	3	014280010
11	3/8	36	13,50	2	014280011
12	3/8	36	13,50	2	014280012
13	3/8	36	13,50	2	014280013
14	3/8	36	13,50	2	014280014
15	1/2	38	14,50	2	014280015
16	1/2	38	14,50	2	014280016
17	1/2	38	14,50	2	014280017
18	1/2	38	14,50	2	014280018
19	1/2	38	14,50	2	014280019
20	1/2	38	14,50	2	014280020
21	1/2	38	14,50	2	014280021
22	1/2	38	15,50	2	014280022
24	1/2	38	15,50	2	014280024
27	1/2	38	16,50	2	014280027



1428/SB11	€	Imp.	Info
8-10-11-12-13-14 15-16-17-18-19 mm	164,50	1	014280111
1428/SB5	82,50	1	014280115
20-21-22-24-27 mm			

1428L

estrattori a bussola lunghi per dadi destrorsi danneggiati con attacco quadro



mm	€	Imp.	Info
17	36,00	1	014280217
19	37,00	1	014280219
21	40,00	1	014280221



1428L/B3	€	Imp.	Info
17-19-21 mm	113,00	1	014280303

1429

estrattori per viti e prigionieri danneggiati con attacco quadro



mm	□	L mm	€	Imp.	Info
2	3/8	60	9,00	3	014290002
3	3/8	60	9,00	3	014290003
4	3/8	60	9,00	3	014290004
5	3/8	60	9,00	2	014290005
6	3/8	60	9,00	2	014290006
8	1/2	70	10,20	2	014290008
10	1/2	70	10,20	2	014290010



3/8"
1/2"

1429/SB7
2-3-4-5-6-8-10 mm

€ 73,00 1 014290107

1430/...

estrattori conici per viti e prigionieri spezzati in acciaio legato

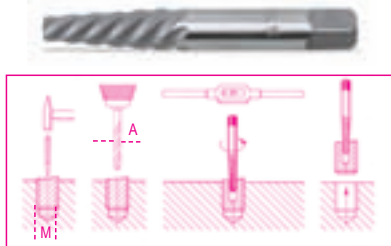

	M	A	€		
	mm	mm			
1430/1	3÷6	2,5	2,30	10	014300006
1430/2	6÷8	3,0	2,50	10	014300008
1430/3	8÷11	4,5	3,00	10	014300011
1430/4	11÷14	6,0	3,90	10	014300014
1430/5	14÷18	8,0	4,50	10	014300018
1430/6	18÷24	11,0	8,80	5	014300024
1430/7	24÷33	14,0	13,80	5	014300033
1430/8	33÷50	21,0	18,00	5	014300050



1430/S5	€ 17,00	1	014300105
1430/1-1430/2-1430/3			
1430/4-1430/5			
1430/S6	€ 25,00	1	014300106
1430/1-1430/2-1430/3			
1430/4-1430/5-1430/6			
1430/S8	€ 57,00	1	014300108
1430/1-1430/2-1430/3			
1430/4-1430/5-1430/6			
1430/7-1430/8			

1433

estrattori a rulli per viti prigioniere

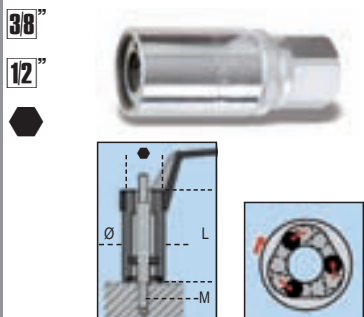

M	Ø	L	•	€	
mm	mm	mm	mm		
5	21	60	19	9,00	2 014330005
6	24	60	21	9,00	2 014330006
7	24	60	21	9,00	2 014330007

M	Ø	L	•	€	
mm	mm	mm	mm		
8	24	60	21	9,00	2 014330008
9	28	70	21	10,50	2 014330009
10	28	70	21	10,50	2 014330010
10,5	28	70	21	10,50	2 014330021
11	28	70	21	10,50	2 014330011
12	28	70	21	10,50	2 014330012
14	36	72	24	17,00	2 014330014
16	36	72	24	17,00	2 014330016

1433/C11

estrattori a rulli per viti prigioniere



1433/C11

M5 - M6 - M7 - M8 - M9 - M10 - M10,5
M11 - M12 - M14 - M16

€ 187,00 1 014330311

340x135x56 mm - 3,0 kg

1435

estrattore ad eccentrico per viti prigioniere



Ø mm 4÷20

€ 72,00 1 014350001

1435R

rotella di ricambio per 1435



1435R

€ 21,00 1 014350010

1435/1

estrattore ad eccentrico per viti prigioniere



Ø mm 19÷26

€ 93,00 1 014350002

1435/1R

rotella di ricambio per 1435/1



1435/1R

€ 21,50 1 014350011

1437/C12

assortimento 12 utensili per rimozione air bag



1437/C12

€ 68,00 1 014370001

260x160x55 mm - 1 kg

1438

attrezzo universale per centraggio frizioni completo di 3 coni ad espansione



1438

€ 49,00 1 014380001

1438R

coni ad espansione di ricambio per 1438



Ø mm

14÷18	€ 2,50	5	014380101
18÷21	€ 2,50	5	014380102
22÷25	€ 2,50	5	014380103

1439/K7

cassetta giravite angolare 90° tipo lungo con lame



Dotazione valigetta:

- Giravite angolare
- 1 Testa per viti ad intaglio
- 1 Testa per bits 1/4
- 1 Testa per lame speciali
- 7 lame speciali

1439/K7

€ 155,00 1 014390101

500x120x60 mm 825 g

1440/...

attrezzi per inserimento pistoni



	Ø mm	L mm	€		
1440/0	40÷75	50	21,00	1	014400000
1440/1	57÷125	80	29,00	1	014400010
1440/1A	57÷125	100	33,00	1	014400011
1440/2	90÷175	80	35,00	1	014400020
1440/2A	90÷175	100	37,00	1	014400021
1440/3	90÷175	165	55,00	1	014400030

1445/1 - 1445/2

attrezzi per segmenti di pistoni



	Ø mm	€		
1445/1	50÷100	29,00	1	014450001
1445/2	90÷150	39,00	1	014450002

1450GC

morsetto alzavalvole con ganasce diritte e curve

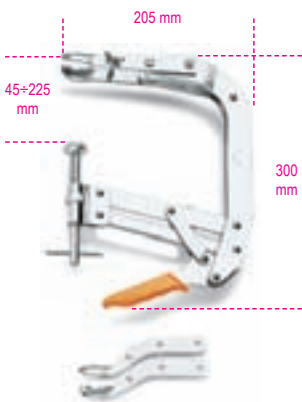

1450GC	€ 79,00	1	014500005
--------	---------	---	-----------

1452K

morsetto alzavalvole con tre flange

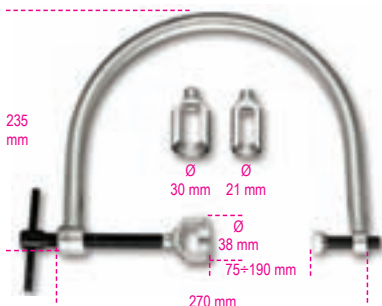

1452K	€ 99,00	1	014520100
-------	---------	---	-----------

1452PN/K

attrezzo pneumatico per molle valvole motore

pressione di spinta 1400 N



Ø mm	L mm	L1 mm	€		
16-19-23	230	185	230,00	1	014520110
25-30-42					

1455SVP

smerigliavalvole pneumatico

• Pressione di utilizzo 6 Bar

CE

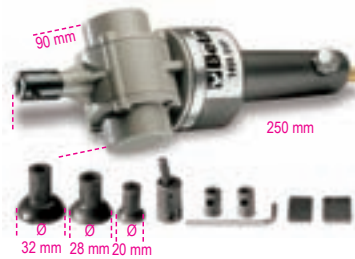

1455SVP	€ 285,00	1	014550001
---------	----------	---	-----------

1455SVP/R...

ventose in gomma di ricambio per 1455SVP



1455SVP/R1	€ 4,50	5	014550501
1455SVP/R2	€ 4,50	5	014550502
1455SVP/R3	€ 4,50	5	014550503

1458

pinza per anelli elastici di sicurezza SP per alberi



DIN 5417

Ø mm	€		
30÷100	47,00	3	014580001

1460F

pinza per anelli di tenuta valvole



1460F	€ 47,00	1	014600010
-------	---------	---	-----------

1461PMS

tastatore per la ricerca del punto morto superiore



M	Ø mm	L mm	€		
14x1,25	19,0	240	67,00	1	014610500

1461BF

blocchetti messa in fase motori Fiat-Alfa Romeo-Lancia



	€		
1461BF/N	33,00	1	014610501
1461BF/AG	67,00	1	014610502
1461BF/R	123,00	1	014610503
1461BF/B	67,00	1	014610504
1461BF/O	67,00	1	014610505
1461BF/V	67,00	1	014610506
1461BF/GR	67,00	1	014610507
1461BF/S	67,00	1	014610508
1461BF/VI	67,00	1	014610509
1461BF/BR	67,00	1	014610510
1461BF/T	67,00	1	014610511
1461BF/A	67,00	1	014610512

1461/C3B

attrezzi per la messa in fase motori Fiat/Alfa/Lancia benzina

Motori: 1.2-1.4 16V



1461/C3B	€ 250,00	1	014610031
----------	----------	---	-----------

335x145x60 mm 1,5 kg

1461/C5G

attrezzi per la messa in fase motori Fiat/Alfa/Lancia/Opel/Suzuki/Ford Diesel

Motori: 1.3 Multijet



1461/C5G	€ 214,00	1	014610052
----------	----------	---	-----------

420x125x60 mm 2,6 kg

1461/C6B

attrezzi per la messa in fase motori Peugeot/Citroën benzina

Motori: 1.0-1.1-1.4-1.6-1.6 16v-1.6Gti-1.6 18V-1.8-1.8 16v-1.9-2.0-2.0 16v-2.0T-2.0 Hpi-2.2 16v



1461/C6B € 351,00 1 014610061

420x280x60 mm 4,2 kg

1461/C6G

attrezzi per la messa in fase motori Peugeot/Citroën Diesel

Motori: 1.4-1.6-2.0D, 1.4-1.6TDCI, 1.4-1.6-2.0-2.2Hdi, 1.5-1.9-2.5D



1461/C6G € 431,00 1 014610062

420x280x60 mm 4,3 kg

1461/C7B

attrezzi per la messa in fase motori Renault/Nissan benzina

Motori: 1.4-1.6-1.8-2.0 16V



1461/C7B € 271,00 1 014610071

420x280x60 mm 4 kg

1461/C8B

attrezzi per la messa in fase motori Ford benzina

Motori: 1.25-1.4-1.6-1.6 SCTi-1.6 Ti-VCT-1.6 16V



1461/C8B € 197,00 1 014610081

420x185x60 mm 2,2 kg

1461/C8G

attrezzi per la messa in fase motori Ford/Mazda Diesel

Motori: 1.4-1.6-1.8-2.0-2.2 TDCi, 1.6D 8/16V, 1.8D, 1.8D Turbo, 1.8 TCi, 1.8 TDDi, 2.5D, 2.5D Turbo



1461/C8G € 322,00 1 014610082

420x185x60 mm 3 kg

1461/C9B

attrezzi messa in fase motori Opel benzina

Motori: 1.0 12V, 1.0-1.2-1.4 16V



1461/C9B € 162,00 1 014610091

335x145x60 mm 2 kg

1461/C10A

attrezzi per messa in fase motori Audi, Seat, Skoda, Volkswagen Diesel

Motori: 1.9 - 2.0 TDI



1461/C10A € 183,00 1 014610101

270x120x45 mm - 1,1 kg

1461/C10G

attrezzi per la messa in fase motori Volkswagen/Audi/Seat e Skoda Diesel

Motori: 1.2-1.6-2.0 TDI CR (common rail)



1461/C10G € 432,00 1 014610102

420x185x60 mm 3,3 kg

1461/C11A

attrezzi per messa in fase motori Renault Diesel

Motori: 2.0 dCi



1461/C11A € 139,00 1 014610111

420x280x60 mm - 1,2 kg

1461/C11G

attrezzi per la messa in fase motori Renault Diesel

Motori: 1.5-1.9-2.2-2.5 dCi



1461/C11G € 366,00 1 014610112

420x280x60 mm 4,6 kg

1461/C12A

attrezzi messa in fase motori Fiat benzina e Diesel

Motori: 1.9-2,2 JTS e 1,9 JTD Euro 4



1461/C12A € 238,00 1 014610121

420x185x60 mm - 1,8 kg

1461/C12G

attrezzi per la messa in fase motori Fiat/Alfa/Lancia Diesel

Motori: 1.9 JTD, 1.6-1.9-2.0 Multijet



1461/C12G € 176,00 1 014610122
335x145x60 mm - 2 kg

1461/C13A

attrezzi per messa in fase motori Fiat benzina

motori: 0.9 Twinair turbo



1461/C13A € 147,00 1 014610131
400x300x60 mm - 1,7 kg

1461/C13B

attrezzi per messa in fase motori Fiat benzina

Motori: 1.4 Multiair



1461/C13B € 200,00 1 014610132
400x300x60 mm - 4,8 kg

1461/C14

attrezzi per messa in fase motori BMW

Motori: VANOS e Valvetronic



1461/C14 € 643,00 1 014610140
420x185x60 mm - 4,0 kg

1461/C15

attrezzi per messa in fase motori BMW (da usare con il 1461/C14)

Motori: Valvetronic



1461/C15 € 618,00 1 014610150
420x280x60 mm - 4,0 kg

1461/C16

attrezzi per messa in fase motori BMW Diesel completo di estrattore pompa
Motori: 2.0-3.0 Diesel



1461/C16 € 303,00 1 014610160
335x145x60 mm - 4,3 kg

1461/C17

attrezzi per messa in fase motori Volkswagen, Seat, Skoda benzina

Motori: 1.2 6-12V



1461/C17 € 140,00 1 014610170
142x102x40 mm - 1,5 kg

1461/C17B

attrezzi per la messa in fase motori Volkswagen/Audi/Seat e Skoda benzina

Motori: 1.2 TSI



1461/C17B € 95,00 1 014610171

1461/C18

attrezzi per messa in fase motori Volkswagen, Audi, Skoda benzina

Motori: 1.4 - 1.6 FSI



1461/C18 € 188,00 1 014610180
335x145x60 mm - 1 kg

1461/C18B

attrezzi per la messa in fase motori Volkswagen/Audi/Seat e Skoda benzina

Motori: 1.6-1.8-1.8T, 1.4-1.6-1.8-2.0 16V, 1.4-1.6-2.0 FSI



1461/C18B € 337,00 1 014610181
420x185x60 mm - 3 kg

1461/C19

attrezzi per messa in fase motori Ford Diesel

Motori: 2.0-2.2-2.4 Duratorq



1461/C19 € 308,00 1 014610190
420x185x60 mm - 1,5 kg

Beta

1461/C20G

attrezzi per la messa in fase motori
Fiat Iveco/Peugeot/Citroën/Ford Diesel

Motori: 2.2-2.3-3.0 Multijet



1461/C20G € 599,00 1 014610200

420x280x60 mm - 6,4 kg

1463/KIT

kit attrezzatura per blocco pulegge
distribuzione



1463/KIT € 325,00 1 014630001

280x140x75 mm - 1,2 kg

1467

strumento estrazione liquido freni



Pressione min 5 bar, Max 11,5 bar

1467 1,5 € 250,00 1 014670001

1467LF

strumento elettrico per sostituzione
liquido freni
dotato di "effetto pulsante"



- Stop automatico con tanica vuota, che impedisce l'inserimento di aria
 - Volume massimo tanica: 20L
 - Pressione di esercizio: 0,4+3,5 bar
 - Alimentazione 230V
- Dotazione inclusa:
- Tanica di recupero olio dai freni
 - 1 tappo universale + 1 tappo E20 standard

1467LF € 1.480,00 1 014670100

1468N

attrezzi per sostituzione
piattelli valvole

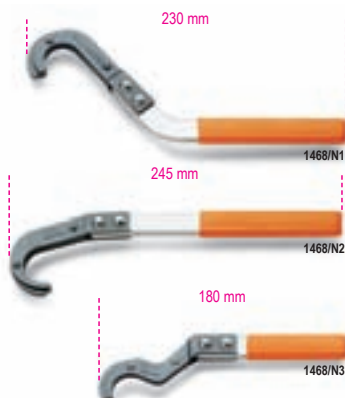

1468N/1	€ 18,00	1	014680011
1468N/2	€ 18,00	1	014680012
1468N/3	€ 18,00	1	014680013

1469

pinza regolabile
autobloccante, per occlusione tubi
impianto frenante



1469 € 41,00 1 014690001

1469C

svasatore tubi freno in cassetta



SAE J514
SAE J1065
DIN 74234

3/16" \varnothing 4,75 mm	€ 447,00	1	014690100
-----------------------------	----------	---	-----------

350x300x105mm - 6 Kg

1469C-R

kit matrici e puntali
per svasatura tubi freno

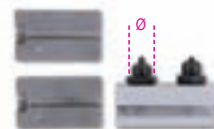

SAE J514
SAE J1065
DIN 74234

1469C-R 3/16" \varnothing 3/16"	€ 85,00	1	014690501
1469C-R 4,75 4,75 mm	€ 85,00	1	014690502
1469C-R 6 6 mm	€ 85,00	1	014690503
1469C-R 8 8 mm	€ 85,00	1	014690504
1469C-R 10 10 mm	€ 85,00	1	014690505
1469C-R 12 12 mm	€ 85,00	1	014690506

1469D

tester liquido freni digitale
in valigetta di plastica



- Permette di testare i liquidi frenanti DOT
- Misura il punto di ebollizione del liquido freni
- Test automatico, con commutazione della scala in gradi °C/°F
- Precisione: 100 - 180 °C +/- 3% > 180 °C +/- 5%
- Alimentazione: 12 Volt (batteria del veicolo)

1469D	€ 680,00	1	014690110
-------	----------	---	-----------

310x230x100 mm - 1,1 kg

1470

pinze per molle freni a tamburo

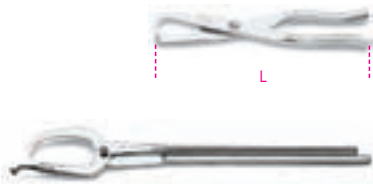

L mm	€	Icona	Articolo
210	26,00		1 014700001
330	40,00		1 014700002
540	122,00		1 014700010

1470FT

pinza per fermi molle ceppi freni a tamburo

Becchi inclinati a 40°
Accesso facilitato nei punti scomodi

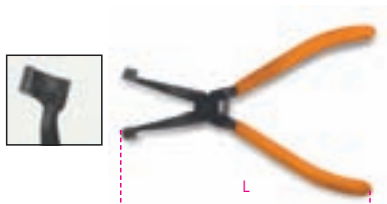

L mm	€	Icona	Articolo
184	28,00		1 014700000

1471

pinza per molle freni a tamburo



L mm	€	Icona	Articolo
330	61,00		1 014710001

1471A

pinza per cavo freno a mano



A max mm	B mm	€	Icona	Articolo
45	5	46,00		2 014710010

1471U

assortimento attrezzi per ruotare e arretrare pistoncini freni destrorsi e sinistrorsi



1471U	410,00		1 014710050
≡ 410x300x100 mm - 4,4 kg			

1471M/C22

utensile pneumatico per arretrare e ruotare i pistoncini dei freni a disco destrorsi e sinistrorsi con accessori



1471M/C22	219,00		1 014710101
≡ 350x310x85 mm - 3,5 kg			

1471M/50

martinetto pneumatico per arretrare e ruotare i pistoncini dei freni a disco destrorsi e sinistrorsi

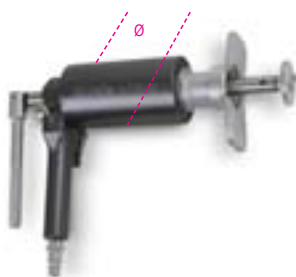

Ø mm	Kg	Bar	€	Icona	Articolo
50	150	5÷8	125,00		1 014710069

1471M/P

adattatore per pastiglie usurate e pinze TRW-Mégane



1471M/P	20,00		1 014710080
---------	-------	--	-------------

1471M/W50

adattatore per freno stazionamento VW Passat ≥ 2005

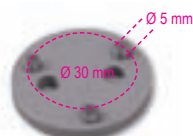

1471M/W50	7,00		1 014710079
-----------	------	--	-------------

1471PN/B1

adattatore per freno stazionamento Ford



1471PN/B1	7,00		1 014710081
-----------	------	--	-------------

1471PN/B2

adattatore per freno stazionamento Daily



1471PN/B2	10,00		1 014710082
-----------	-------	--	-------------

1471PN/B3

adattatore per freno stazionamento BMW

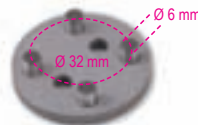

1471PN/B3	7,00		1 014710083
-----------	------	--	-------------

1471PN/B4

adattatore per freno stazionamento BMW

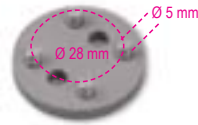

1471PN/B4	7,00		1 014710084
-----------	------	--	-------------

1471PN/B5

adattatore per freno stazionamento Mini/ BMW

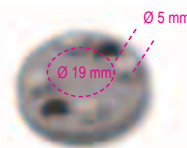

1471PN/B5	6,00		1 014710085
-----------	------	--	-------------

1471CF

chiavi a bussola a mano bocca pentagonale per dadi pinze freno



mm	€	Icona	Articolo
14	12,50		1 014710314
19	12,50		1 014710319

1471CM

chiave a bussola maschio pentagonale per viti pinze freno



12"



mm 10 € 12,50 1 014710360

1471CM/E11

chiave a bussola maschio esagonale 11 mm per viti pinze freno Mercedes ML (serie 166)

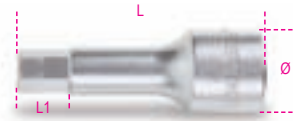

mm Ø mm L mm L1 mm € 11,00 1 014710361

1471D

arretratore pistoncini freni a disco con pinze chiuse

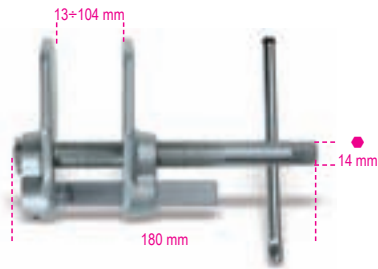

1471D € 102,00 1 014710300

Articolo ad esaurimento

1471/S4

serie di quattro pinze per ritenzione pistoncini freni a tamburo

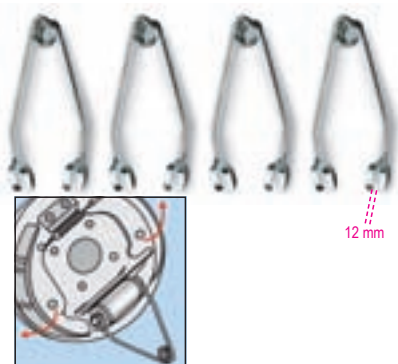

1471/S4 € 65,00 1 014710250

1472

pinza per anelli stringitubo



1472 € 35,00 1 014720001

1472AU

pinza automatica per anelli stringitubo



Ø mm 18÷53 € 100,00 1 014720100

1472AU/P

pinza automatica con prolunga per anelli stringitubo



Ø mm 18÷54 L mm 630 € 100,00 1 014720105

1472FC

pinza con teste orientabili, per fascette Clic®



1472FC € 29,00 1 014720090

1472FC/L

pinza con prolunga flessibile, per fascette Clic®



L 630 mm € 83,00 1 014720095

1472TM

pinza per scollegare i raccordi rapidi dei filtri multijet



1472TM € 18,00 1 014720200

1473

pinza per collari OETIKER®



1473 € 98,00 1 014730001

1473A

pinza con reggiasola per collari OETIKER®



1473A € 70,00 1 014730010

1473Q

pinza con quadro di manovra, per collari OETIKER®

- Utilizzabile con:
- chiavi dinamometriche
 - cricchetti
 - quadri maschi di manovra

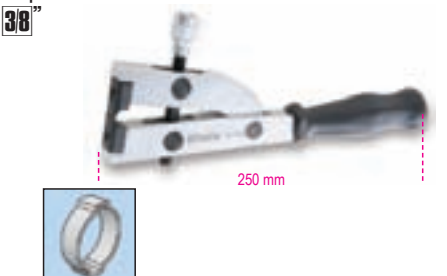

1473 Q € 68,00 1 014730005

1474/C4

kit 4 utensili estrazione bobine candele Volkswagen



1474/C4 € 72,00 1 014740100

290x190x50 mm - 1 kg

1474L

pinza per cappucci candele d'accensione a becchi lunghi piegati 15°

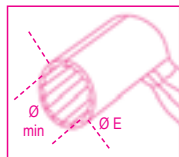

Ø min mm 14 Ø E mm 20 € 61,00 2 014740010

1474DL

pinza per cappucci candele d'accensione a becchi lunghi manici ricoperti con 2 strati in PVC



1474DL € 24,00 1 014740015

1475U

pinza universale cromata lucida con impugnatura a "pistola" manici ricoperti con 2 strati in PVC

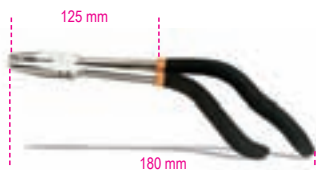

1475U € 31,00 1 014750010

1476

pinza regolabile autobloccante per taglio tubi di scarico

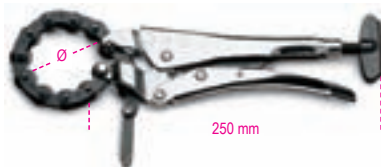

Ø min mm 19 Ø max mm 75 € 96,00 1 014760001

1476/RC

catena di ricambio per 1476



1476/RC € 74,00 1 014760010

1476A

pinza per taglio tubi di scarico



Ø min mm 30 Ø max mm 95 € 75,00 1 014760005

1476A/RC

catena di ricambio per 1476A



1476A/RC € 70,00 1 014760015

1476C/1 - 1476C/2

attrezzi espansori per tubi di scarico



1476C/1 € 40,50 1 014760101

Ø 30=42 mm
L = 131 mm
L1 = 51 mm

1476C/2 € 58,00 1 014760105

Ø 39=62 mm
L = 164 mm
L1 = 64 mm

1476T

chiave per smontaggio/montaggio turbine su motori diesel, gruppo Volkswagen Audi



Ø mm 12 € 26,00 1 014760200

1477D

chiavi poligonali per dadi tendicinghia



Ø mm 13 € 20,00 1 014770113
15 € 20,00 1 014770115
16 € 20,00 1 014770116
17 € 20,00 1 014770117
19 € 20,00 1 014770119

1477D/S5

serie di 5 chiavi poligonali per dadi tendicinghia



1477D/S5 € 100,00 1 014770200

13-15-16-17-19 mm

600x200x70 mm - 2,2 kg

1477K/7

kit chiave curva a cricchetto reversibile con inserti



- 2 Inserti Torx® T40-T45
- 1 Inserto XZN° 10
- 1 Inserto esagonale 8 mm
- 3 Inserti poligonali 10-12-13 mm

L mm 250 € 108,00 1 014770051

1478

pinza per estrazione pioli



1478 € 41,00 1 014780001

1479

estrattore per pioli

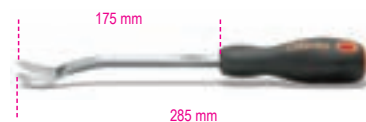

1479 € 18,00 2 014790001

1479RB/1

raschietto a battere tipo diritto



1479RB/1 € 25,50 1 014790315

1479RB/2

raschietto a battere tipo piegato



1479RB/2 € 25,50 1 014790320

1479RB/3

raschietto a battere tipo piatto



1479RB/3 € 28,50 1 014790310

1479U/13

levapioli lama inox

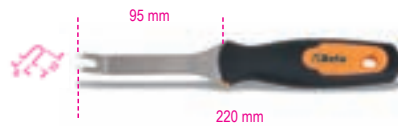

1479U/13 € 26,50 2 014790010

1479U/32

levapioli lama inox



1479U/32 € 33,00 2 014790015

1479N/S5

kit di 5 levapioli in nylon



1479N/S5 € 29,00 1 014790251

1481PL/A

pinza in plastica per occlusione tubi e manicotti



Ø mm 8÷15 € 14,50 3 014810110

1481PL/B

pinza in plastica per occlusione tubi e manicotti



Ø mm 15÷25 € 16,50 3 014810120

1481PL/C

pinza in plastica per occlusione tubi e manicotti



Ø mm 25÷45 € 23,00 3 014810130

1481PL/S3

serie di 3 pinze in plastica per occlusione tubi e manicotti

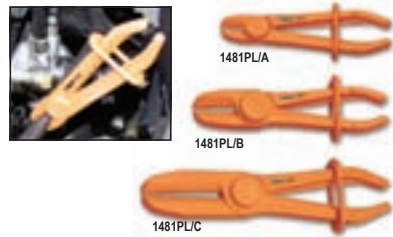
1481PL/S3 € 54,00 1 014810200
1481PL-A Ø 8÷15 mm
1481PL-B Ø 15÷25 mm
1481PL-C Ø 25÷45 mm**1482/8 - 1482/10**

pinze per raccordi rapidi tubi carburante

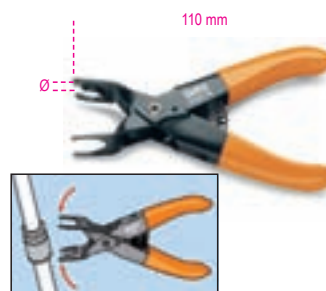
Ø mm 8 € 37,50 2 014820008
1482/10 10 € 37,50 2 014820010**1482A**

pinza per raccordi rapidi tubi carburante

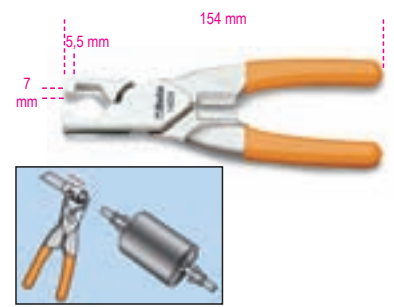

1482A € 58,00 2 014820020

1482G/...

chiavi regolabili per ghiera per galleggianti serbatoio carburante

Ø mm 85÷120 € 55,00 1 014820025
1482G/2 118÷165 € 56,00 1 014820030
1482G/3 160÷205 € 61,00 1 014820035**1483K/22**

kit per la separazione di raccordi su impianti di condizionamento, alimentazione e lubrificazione



1483K/22 € 95,00 1 014830022

300x230x55 mm - 1 kg

1484

set di 2 utensili per la rimozione e il montaggio delle cinghie elastiche

Permette una rapida rimozione e un corretto montaggio della cinghia elastica senza rischio di danneggiamento



1484 € 91,00 1 014840010

1485/KIT

kit attrezzi per controllo tensione cinghia distribuzione



1485/KIT € 250,00 1 014850100

230x140x75 mm - 580 g

1485R

attrezzo per rotazione pulegge distribuzione in acciaio forgiato con 2 coppie di puntali



∅ mm 30÷120 ∅1 mm 10 - 17 L mm 500 € 119,00 1 014850025

1485R/P10

coppie di puntali



1485R/P10 € 9,50 1 014850035

1485R/P17

coppie di puntali



1485R/P17 € 11,00 1 014850038

1486T

chiave per pulegge a gola trapezoidale e a V



∅ mm 40÷140 € 80,00 1 014860001

1486M

chiave per pulegge multigola



∅ mm 40÷140 € 92,00 1 014860002

1488 - 1488L

chiave snodata a catena doppia per filtri olio



∅ mm 1488 60÷110 € 68,00 1 014880001
1488L 60÷160 € 74,00 1 014880050

1488/1

chiave a catena doppia sottile per filtri olio



∅ mm 12" 60÷110 € 83,00 1 014880010

1489/31T

chiave per ruota libera puleggia alternatore



T50 ∅ 15 31 € 30,00 1 014890016

1489/33

chiave per ruota libera puleggia alternatore Bosch



1489/33 33 € 10,50 3 014890010

1489/33P

chiave per ruota libera puleggia nuovo alternatore Bosch FIAT Grande Punto



M 10 ∅ mm 15 31 € 36,00 1 014890015

1489/E

chiave per ruota libera puleggia alternatore



∅ mm 10 ∅ mm 15 € 25,00 1 014890025

1489R

chiave per ruota libera puleggia alternatore Renault



1489R € 11,50 1 014890020

1489/Y

chiave per ruota libera puleggia alternatori Nippondenso



∅ mm 32 € 14,00 3 014890040

1489/C14

assortimento di 14 utensili per le pulegge libere degli alternatori



1489/C14 € 210,00 1 014890100

- 867PE 8 mm
- 867PE/L 8 mm
- 867XZN/L M10
- 867TX/L T50
- 867/2 □1/2"
- 920B 10 mm
- 1489/33
- 12" 1489/33P M10
- 1489R
- 1489/Y
- 1489/31T T50
- 1489/E 10 mm
- 188 10 mm
- 188 15 mm

420x250x45 mm - 1,9 kg

1490/1 - 1490/2

chiavi a nastro per filtri olio

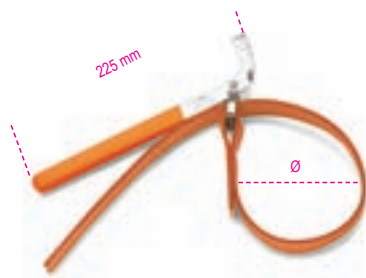

	Ø max mm	€		
1490/1	160	27,00	1	014900001
1490/2	240	29,00	1	014900002

1491

chiave a nastro metallico regolabile per filtri olio



	Ø mm	€		
1491R	65÷110	34,50	2	014910001

1491R

nastro metallico di ricambio per 1491



1491R	€ 6,00	10	014910010
-------	--------	----	-----------

1491C

pinza regolabile per filtri olio



	Ø mm	L mm	€		
1491C	60÷100	300	23,50	1	014910030

1492/1 - 1492/2

chiavi regolabili per filtri olio

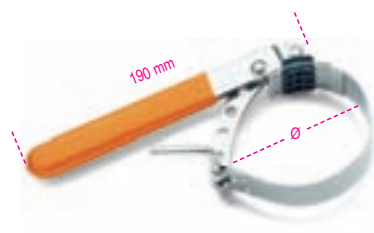

	Ø mm	€		
1492/1	60÷80	35,50	1	014920001
1492/2	80÷110	36,50	1	014920002

1492T

chiavi per filtri essiccatori



	Ø mm	H mm	€		
1492/T40	125÷145	40	23,00	1	014920540
1492/T75	120÷140	75	43,00	1	014920575

1493

chiave a bussola per filtri olio

N=numero lati



Ø mm	N	€		
65	14	6,50	1	014930200
68	14	6,50	1	014930206
73	14	6,50	1	014930208
74	15	6,50	1	014930210
77	15	6,50	1	014930212
76	8	6,50	1	014930214
76	14	6,50	1	014930218
76	15	7,00	1	014930220
78	15	7,00	1	014930224
80	15	7,00	1	014930226
82	15	7,50	1	014930228
86	16	7,50	1	014930230
90	15	7,50	1	014930234
92	10	7,50	1	014930236
93	15	7,50	1	014930238
95	15	7,50	1	014930244
100	15	9,50	1	014930248
106	15	9,50	1	014930250
108	15	9,50	1	014930252
135	18	15,50	1	014930256

1493/PF

chiavi a bussola per filtri olio Purflux

N=numero lati



Ø mm	N	€		
66	6	6,50	1	014930202
76	12	6,50	1	014930216
76	30	7,00	1	014930222
86	9	27,00	1	014930065
86	18	7,50	1	014930232
93	36	7,50	1	014930240
93	45	7,50	1	014930242
96	9	27,00	1	014930070
96	18	7,50	1	014930246
108	18	10,00	1	014930254

1493/C30

Serie di 28 chiavi a bussola per filtri olio



Misure incluse nel kit (Ø mm / n° lati)
1493:
65/14 - 67/14 - 68/14 - 73/14 - 74/15
76/15 - 75.77/15 - 76/14 - 76/8 - 78/15 - 80/15
82/15 - 86/16 - 90/15 - 92/10 - 93/15 - 95/15
100/15 - 106/15 - 108/15

1493PF (Purflux)
66/6 - 76/12 - 76/30 - 86/18
93/36 - 93/45 - 96/18 - 108/18

- Inclusa 1 chiave regolabile universale
Ø 65÷120 mm

1493/C30	€ 183,00	1	014930000
----------	----------	---	-----------

1493/S-U

chiave autoregolabile a tre bracci per filtri olio destrorsa-sinistrorsa

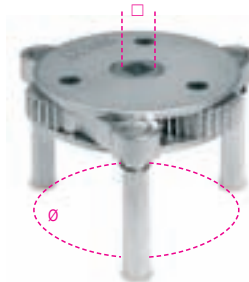

		Ø mm	€		
1493/S	3/8-1/2	80-115	59,00	1	014930074
1493/U	1/2	105-165	147,00	1	014930076

1493T

chiave autoregolabile a tre bracci per filtri olio destrorsa

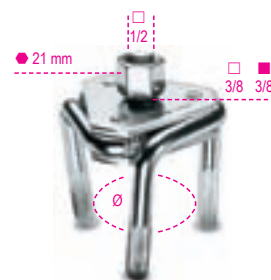

	Ø mm	€		
1493T	60÷120	21,00	1	014930075

Beta

1493J

chiave per filtri gasolio Multijet

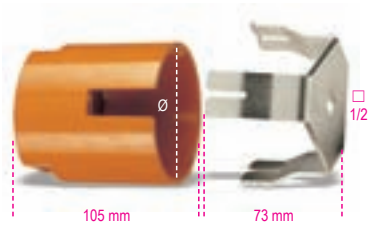

Ø mm	€		
90	79,00	1	014930080

1493Z/1 - 2 - 3

chiavi autoserranti per filtri olio sinistrorse

12"



	Ø mm	€		
1493Z/1	60÷80	45,00	1	014930090
1493Z/2	80÷100	52,00	1	014930095
1493Z/3	100÷125	61,00	1	014930100

1494

chiave a bussola quadrata per tappi olio motore

12"



mm	€		
10	6,00	1	014940280

1494E

chiavi a bussola maschio esagonale per tappi olio motore

12"



mm	€		
8	6,00	1	014940208
9	6,00	1	014940209
10	6,00	1	014940210
11	6,00	1	014940211
12	6,00	1	014940212
14	6,00	1	014940214
17	6,00	1	014940217

1494Q

chiavi a bussola maschio quadrato per tappi olio motore

12"



mm	€		
8	6,00	1	014940258
9,5	6,00	1	014940259
12	6,00	1	014940262
13	6,00	1	014940263

1494T

chiave a bussola maschio triangolare per tappi olio motore

12"



mm	€		
9,5	6,00	1	014940289

1494XZN

chiave a bussola maschio con profilo XZN® per tappi olio motore

12"



M	€		
16	7,50	1	014940296

1494/C14A

assortimento di 14 utensili per cambio olio

12"



1494/C14A	€		
	91,00	1	014940150

- 1494E 8-9-10-11-12-14-17
- 1494Q 8-9,5(3/8")-12-13
- 1494 10
- △ 1494T 9,5(3/8")
- 1494XZN M16

380x305x40 mm - 1,7 kg

1495/C6

assortimento di utensili per la riparazione dei filetti della coppa olio



- Il filetto danneggiato viene rimosso con il maschio filettato e allargato di una misura
- Consente la riparazione ed evita la sostituzione della coppa olio

Composto da:

- 1 maschio M13x1.25 + 6 viti + 12 rondelle
- 1 maschio M13x1.5 + 6 viti + 12 rondelle
- 1 maschio M15x1.5 + 6 viti + 12 rondelle
- 1 maschio M17x1.5 + 6 viti + 12 rondelle
- 1 maschio M20x1.5 + 6 viti + 12 rondelle
- 1 maschio M22x1.5 + 6 viti + 12 rondelle

1495/C6	€		
	196,00	1	014950500

420x185x60 mm - 2,1 kg

1495M

maschio per filetti tappi olio



M	€		
13x1,25	11,00	1	014950553
13x1,50	9,50	1	014950563
15x1,50	10,00	1	014950565
17x1,50	11,50	1	014950567
20x1,50	13,00	1	014950570
22x1,50	17,00	1	014950572

1495T

kit di 6 tappi olio e rondelle



M	€		
13x1,25	13,50	1	014950503
13x1,50	13,00	1	014950513
15x1,50	13,50	1	014950515
17x1,50	15,50	1	014950517
20x1,50	17,50	1	014950520
22x1,50	23,00	1	014950522

1496/A

chiavi per tappi olio motore



□ 10 x ■ 10 mm	€		
	23,00	2	014960001

1496/B

chiavi per tappi olio motore



□ 10 x ■ 8 mm € 23,00 3 014960005

1496/C

chiavi per tappi olio motore



■ 8 x ■ 10 mm € 15,00 3 014960010

1496/D

chiavi per tappi olio motore



● 10 x ● 12 mm € 15,00 3 014960015

1497D

pinza con becchi dritti per estrazione relé



A min+Max mm € 22,00 1 014970150

1497P

pinza con becchi piegati a 60° per estrazione relé



A min+Max mm € 23,00 1 014970160

1497/C23

assortimento di 23 utensili per sblocco connettori elettrici



1497/C23 € 155,00 1 014970200

≡ 440x250x70 mm - 1,7 kg

1498

provatensione

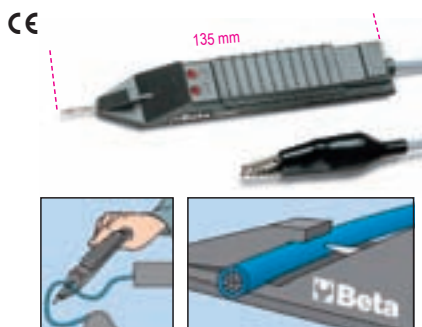

3÷48V € 32,00 2 014980100

1498B/12

avviatore per auto 12V portatile



DATI TECNICI:
 • Corrente di spunto 2200A
 • Tracolla per trasporto inclusa
 • Batteria ermetica al piombo electrolyte solido (AGM)

1498B/12 € 395,00 1 014980205

1498B/24

avviatore per auto e veicoli commerciali 12-24 V portatile



DATI TECNICI
 - Corrente di spunto 4200 A (12 V), 2100 A (24 V)
 - Tracolla per trasporto inclusa
 - Batteria ermetica al piombo electrolyte solido (AGM)

1498B/24 € 990,00 1 014980224

1498C/24

avviatore carrellato 24V



• Struttura carrellata per facilitare gli spostamenti e ridurre al minimo gli sforzi
 • Prestazioni molto elevate per numerosi avviamenti anche particolarmente impegnativi
 • Caricabatterie elettronico in dotazione
 • Segnalazioni led e acustiche in caso di inversione di polarità
 • Sistema di protezione contro i picchi di tensione
 • Indicazione del livello di carica della batteria
 • Batteria ermetica al piombo electrolyte solido (AGM)

Amperaggio continuo 1700 A
 Tensione utilizzo 24 V
 Amperaggio di spunto 4000 A
 Lunghezza cavi 2000 mm
 Sezione cavi 70 mm
 Tensione di ricarica 230 V
 Caricabatterie automatico 24 V - 10 A

1498C/24 € 3.150,00 1 014980244

1498CB/40

caricabatterie elettronico moto



DATI TECNICI
 Alimentazione: 230V
 Potenza: 20W
 Tensione: 12V
 Corrente di carica: 1A
 Capacità nominale di riferimento: 1-40 Ah
ACCESSORI IN DOTAZIONE:
 - Pinze di collegamento
 - Connettore con terminali

1498CB/40 € 81,00 1 014980302

1498CB/M-40

connettore per presa accendisigari moto



1498CB/M-40 € 30,00 1 014980366

1498CB/80

caricabatterie elettronico auto-moto



DATI TECNICI
 Alimentazione: 230V
 Potenza: 60W
 Tensione: 12V
 Corrente di carica: 3,5A
 Capacità nominale di riferimento: 1-110Ah
ACCESSORI IN DOTAZIONE:
 - Pinze di collegamento
 - Connettore con terminali ad occhielli
 - Connettore per presa accendisigari

1498CB/80 € 121,00 1 014980308

1498CB/120

caricabatterie elettronico auto-veicoli commerciali



DATI TECNICI
 Alimentazione: 230V
 Potenza: 110W
 Tensione: 12V
 Corrente di carica: 6,5-1A
 Capacità nominale di riferimento: 4-190Ah
ACCESSORI IN DOTAZIONE:
 - Pinze di collegamento
 - Connettore con terminali ad occhielli
 - Connettore per presa accendisigari

1498CB/120 € 161,00 1 014980312

1498CB/300

caricabatterie elettronico 12-24V



DATI TECNICI
 Alimentazione: 230V
 Potenza: 350W
 Tensione: 12-24V
 Corrente di carica: 15-10A
 Capacità nominale di riferimento: 30-500Ah
ACCESSORI IN DOTAZIONE:
 - Pinze di collegamento
 - Connettore con terminali ad occhielli

1498CB/300 € 510,00 1 014980330

1498TB/ST

tester digitale con stampante per analisi batteria ed impianto di avviamento in valigetta di plastica



Misura lo stato di carica, la capacità e l'efficienza della batteria
 - Verifica l'efficienza dell'alternatore
 - Verifica l'impianto di avviamento
DATI TECNICI
 - Test di batterie: 6 e 12 Volt
 - Intervallo di funzionamento: 40-2000CA (SAE)
 - Normativa di riferimento: SAE, DIN, EN, IEC, JIS
 - Voltmetro: 1.5-30V
 - Schermo: LCD retroilluminato a 4 linee
 - Stampante termica
 - Lingue software: EN-F-E-D-I-P-NL
 - Dotazione: 1 rotolo di carta stampabile, 6 batterie da 1,5V AA

1498TB/ST € 810,00 1 014980471
310x260x85 mm - 2 kg

1499

stetoscopio



1499 € 72,00 1 014990001



1500/...

estrattori universali
a due griffe

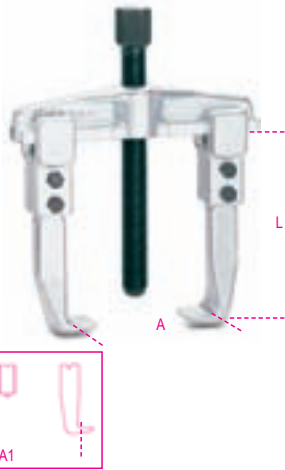

L mm	€		
1500/1 100	58,00	1	015000301
1500/2 100	62,00	1	015000302
1500/3 150	98,00	1	015000303
1500/4 150	138,00	1	015000304
1500/5 205	242,00	1	015000305
1500/6 205	282,00	1	015000306
1500/7 205	450,00	1	015000307
1500/8 230	695,00	1	015000308

A min+max mm	A1 min+max mm
1500/1 25÷80	70÷130
1500/2 25÷130	80÷180
1500/3 50÷160	105÷220
1500/4 60÷200	120÷270
1500/5 80÷250	160÷330
1500/6 80÷350	160÷420
1500/7 110÷520	195÷600
1500/8 170÷640	260÷715



	€		
1500/SP5 1500/1-1500/2-1500/3 1500/4-1500/5	643,00	1	015000325
1500/SPV	49,00	1	015000001

1500G/...

coppia di griffe tipo normale
per 1500 e 1580/8I



A mm	1500 griffe	€		
1500G/1 35	/1-2	37,00	1	015000311
1500G/3 35	/3-4	53,00	1	015000313
1500G/5 35	/5-6-7	110,00	1	015000315
1500G/8 50	/8	147,00	1	015000317

1580/8I

1500N/...

estrattori universali
a 2 griffe scorrevoli

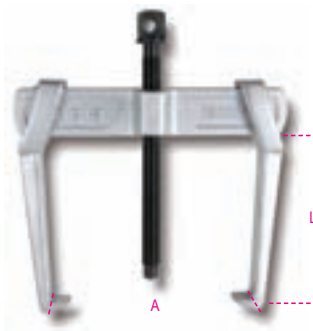

A min+max mm	L mm	€		
1500N/0 18÷65	70	50,00	1	015000600
1500N/1 23÷70	100	55,00	1	015000601
1500N/2 23÷100	100	60,00	1	015000602
1500N/3 35÷140	150	95,00	1	015000603
1500N/4 35÷190	150	105,00	1	015000604
1500N/5 43÷250	205	200,00	1	015000605
1500N/6 43÷320	205	215,00	1	015000606



	€		
1500N/SP6 1500N/0-1500N/1-1500N/2-1500N/3 1500N/4-1500N/5	565,00	1	015000626
1500N/SPV	53,00	1	015000006

1500N/G...

griffe per estrattori 1500N



A mm	1500N griffe	€		
1500N/G0 10	/0	18,50	2	015000650
1500N/G1-2 12	/1-2	20,00	2	015000651
1500N/G3-4 17	/3-4	32,50	2	015000653
1500N/G5-6 23	/5-6	56,00	2	015000655

1501/1 - 2 - 3

estrattori a griffe sottili

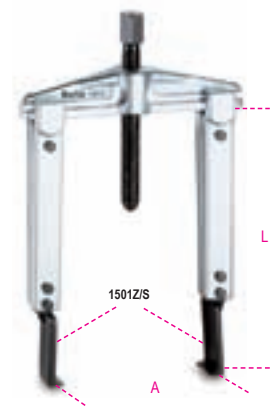

L mm	€		
1501/1 100	142,00	1	015010101
1501/2 200	151,00	1	015010102
1501/3 250	156,00	1	015010103

A min+max mm
1501/1 25÷130
1501/2 25÷130
1501/3 25÷130

1501G/1 - 2 - 3

coppie di griffe per 1501



L mm	€		
1501G/1 100	78,50	1	015010111
1501G/2 200	88,00	1	015010112
1501G/3 250	93,50	1	015010113

1501Z/S - P - R

terminali per griffe 1501G



A mm	D mm	€		
1501Z/S 2,0	27	27,00	2	015010211
1501Z/P 3,6	27	26,00	2	015010212
1501Z/R 3,6	14	29,50	2	015010213



1505

estrattori bracci tergitristallo



A	L	€	Icon	Icon
mm	mm			
22-28-30-35	28	63,00	🔧	📦

1506

estrattore autoserrante a due griffe

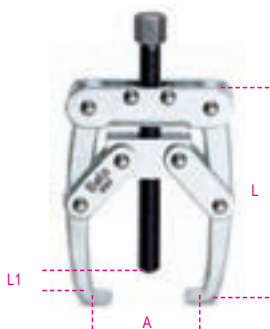

A	L	L1	€	Icon	Icon
min+max	mm	mm			
10÷50	80	40	35,00	🔧	📦

1508/1 - 1508/2

estrattori a due griffe tipo leggero



L	€	Icon	Icon
mm			
1508/1 105	106,00	🔧	📦
1508/2 130	126,00	🔧	📦

A	L1	€	Icon	Icon
min+max	mm			
1508/1 6÷100	105		🔧	📦
1508/2 10÷140	130		🔧	📦

1511/1 - 2 - 3

estrattori a due griffe reversibili per esterni

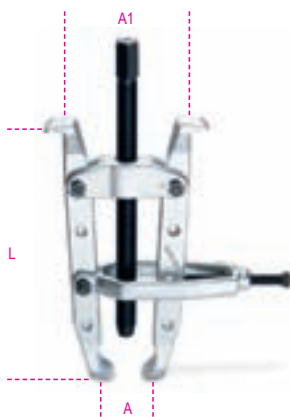

L	€	Icon	Icon
mm			
1511/1 235	195,00	🔧	📦
1511/2 350	245,00	🔧	📦
1511/3 405	290,00	🔧	📦

A	A1
min+max	min+max
mm	mm
1511/1 20÷100	65÷95
1511/2 40÷150	103÷190
1511/3 40÷150	103÷175

1515/1 - 2 - 3

estrattori a due griffe oscillanti

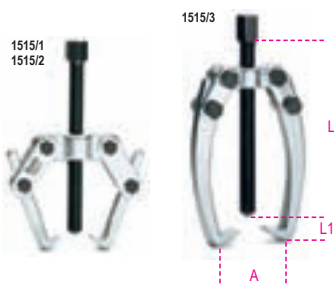

L	€	Icon	Icon
mm			
1515/1 85	26,00	🔧	📦
1515/2 85	28,00	🔧	📦
1515/3 105	40,00	🔧	📦

A	L1
max	mm
mm	mm
1515/1 60	105
1515/2 70	105
1515/3 90	105

1516/1 - 2 - 3

estrattori a tre griffe oscillanti



L	€	Icon	Icon
mm			
1516/1 85	36,00	🔧	📦
1516/2 85	38,00	🔧	📦
1516/3 105	55,00	🔧	📦

A	L1
max	mm
mm	mm
1516/1 60	85
1516/2 70	85
1516/3 90	105

1517

estrattori 3 griffe autoserranti

- Per elevati carichi d'estrazione.
- Effetto autoserrante.

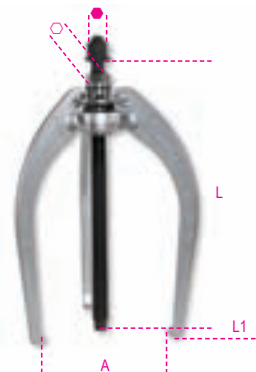

L	L1	€	Icon	Icon
mm	mm			
1517/90 182	60	180,00	🔧	📦
1517/150 242	115	198,00	🔧	📦
1517/200 307	150	227,00	🔧	📦
1517/260 395	180	255,00	🔧	📦

●	A	kg	N
mm	mm		
1517/90 19	18÷90	6000	59000
1517/150 19	25÷150	6000	59000
1517/200 19	40÷200	6000	59000
1517/260 27	50÷260	8000	78500

1517G

3 griffe per estrattori 1517



mm	€	Icon	Icon
mm			
1517G/90 8	50,00	🔧	📦
1517G/150 13	60,50	🔧	📦
1517G/200 13	84,50	🔧	📦
1517G/260 15	101,00	🔧	📦



1517GS

3 griffe sottili per estrattori 1517



1517GS/150	L mm	€	1	015170209
	224,5	47,50		

1517T

traverse per estrattori 1517



1517T/90-150-200	€	1	015170410
	32,00		
1517T/260	€	1	015170430
	45,50		

1517V

viti di ricambio per 1517



1517V/90	mm	L mm	€	1	015170100
	19	182	26,00		
1517V/150	mm	L mm	€	1	015170110
	19	242	29,00		
1517V/200	mm	L mm	€	1	015170120
	19	307	33,00		
1517V/260	mm	L mm	€	1	015170130
	27	395	48,00		

1518/...

estrattori a tre griffe



1518/1	L mm	€	1	015180001
	105	65,00		
1518/2	L mm	€	1	015180002
	150	81,00		
1518/3	L mm	€	1	015180003
	220	139,00		
1518/4	L mm	€	1	015180004
	240	200,00		
1518/5	L mm	€	1	015180005
	350	230,00		
1518/6	L mm	€	1	015180006
	400	250,00		

1518/1	A min+max mm	L1 mm
	24÷100	105
1518/2	A min+max mm	L1 mm
	32÷160	135
1518/3	A min+max mm	L1 mm
	40÷220	235
1518/4	A min+max mm	L1 mm
	80÷250	270
1518/5	A min+max mm	L1 mm
	80÷300	270
1518/6	A min+max mm	L1 mm
	80÷350	270

1520/1 - 1520/2

estrattori a due griffe reversibili

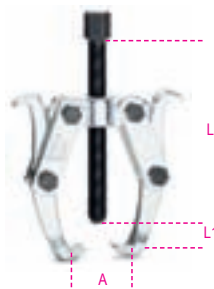

1520/1	L mm	€	1	015200101
	135	61,00		
1520/2	L mm	€	1	015200102
	235	105,00		

1520/1	A max mm	L1 mm
	110	85
1520/2	A max mm	L1 mm
	160	140

1521/1 - 1521/2

estrattori a tre griffe reversibili

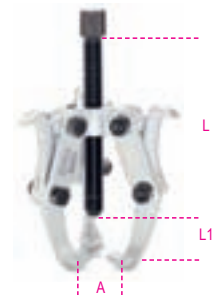

1521/1	L mm	€	1	015210101
	135	79,00		
1521/2	L mm	€	1	015210102
	235	131,00		

1521/1	A max mm	L1 mm
	110	135
1521/2	A max mm	L1 mm
	160	235

1529

estrattore per pulegge multigola



1529	A min+max mm	L min+max mm	L1 min+max mm	€	1	015290000
	24÷240	60÷95	90÷135	188,00		

260x210x60 mm - 2,6 kg

1530/C5

kit per estrazione mozzi e cuscinetti ruote a 3, 4, 5 fori

Il kit comprende:

1 flangia universale 96÷138 mm

1 vite idraulica da 12 tonnellate

1 massa battente da 2,8 kg indispensabile

per mozzetti senza bullone di fissaggio centrale



1530 /C5	€	1	015300300
	390,00		

760x320x120

1532

utensile per rimozione guarnizioni e paraoli



1532	€	2	015320001
	12,00		

1533/...

tiranti per separatori 1534



1533/2	L mm	€	1	015330002
	150	79,00		
1533/3	L mm	€	1	015330003
	210	155,00		
1533/4	L mm	€	1	015330004
	315	240,00		
1533/5	L mm	€	1	015330005
	305	290,00		

1533/2	A min+max mm	L1 mm
	45÷130	110
1533/3	A min+max mm	L1 mm
	85÷225	175
1533/4	A min+max mm	L1 mm
	80÷310	175
1533/5	A min+max mm	L1 mm
	145÷370	235

1533PR/1 - 2 - 3

prolunghe per tiranti 1533



1533PR/1	€	1	015330011
	17,00		
1533PR/2	€	1	015330012
	19,00		
1533PR/3	€	1	015330013
	21,00		

1534/...

separatori

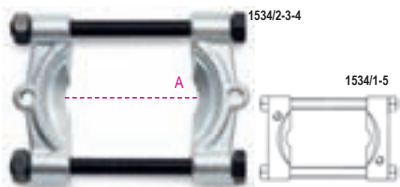

	€		
1534/1	70,00	1	015340001
1534/2	81,00	1	015340002
1534/3	138,00	1	015340003
1534/4	228,00	1	015340004
1534/5	480,00	1	015340005

A	min+max
mm	mm
1534/1	5÷60
1534/2	12÷75
1534/3	22÷115
1534/4	25÷155
1534/5	30÷220

1535/C...

estrattori combinati



	€		
1535/C1	212,00	1	015350001

1533/2
1533PR/1
1534/1

260x180x40 mm - 2,5 kg

	€		
1535/C2	223,00	1	015350002

1533/2
1533PR/1
1534/2

260x180x40 mm - 2,8 kg

	€		
1535/C3	400,00	1	015350003

1533/3
1533PR/2
1534/3

380x280x55 mm - 8,0 kg

	€		
1535/C4	612,00	1	015350004

1533/4
1533PR/3
1534/4

420x380x65 mm - 14,8 kg

1535/C5

€ 937,00 1 015350005



530x510x85 mm - 27,4 kg

1539

tiralamiere a percussione



	€		
1539	110,00	1	015390001

1540

estrattore a percussione

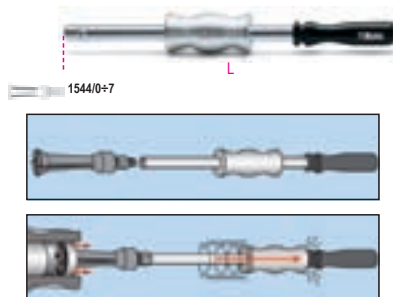

L	mm	1544	€		
1540	390	M10 0÷7	73,00	1	015400001

1542/1 - 1542/2

estrattori per griffe ed espansori



A	min+max	mm	1544	€		
1542/1	35÷75	0÷7	53,00	1	015420001	
1542/2	60÷130	9C-10C	83,00	1	015420002	

L	L1
mm	mm
1542/1	140
1542/2	175

1544/...

espansori a settori per interni

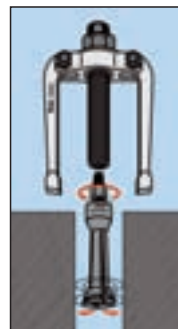

	C	mm	1544	€		
1544/0	0,25	M10	54,00	1	015440100	
A= 5÷7						
1544/A	0,80	M10	55,00	1	015440105	
A= 7÷9						
1544/1	0,80	M10	56,00	1	015440110	
A= 9÷12						
1544/2	1,15	M10	57,00	1	015440120	
A= 13÷17						
1544/2B	1,00	M10	58,00	1	015440121	
A= 14÷19						
1544/3	1,70	M10	59,00	1	015440130	
A= 16÷21						
1544/4	1,65	M10	63,00	1	015440140	
A= 20÷25						
1544/5	2,00	M10	67,00	1	015440150	
A= 25÷30						
1544/6	3,00	M10	80,00	1	015440160	
A= 30÷37						
1544/7	3,80	M10	95,00	1	015440170	
A= 38÷45						
1544/9C	2,60	G 3/8"	140,00	1	015440189	
A= 40÷75						
1544/10C	7,30	G 3/8"	205,00	1	015440199	
A= 70÷115						

1545/C5

estrattore 1542/1 con 5 espansori 1544



	€		
1545/C5	380,00	1	015450001

1542/1	● 24 mm
1544/1	9÷12 mm
1544/2	13÷17 mm
1544/3	16÷21 mm
1544/4	20÷25 mm
1544/5	25÷30 mm

265x180x45 mm - 2,4 kg



1547/C6

estrattori per cuscinetti con false sfere



1547/C6 € 198,00 1 015470006

420x185x60 mm - 3 kg

1547KP

set di 3 coppie di terminali a falsa sfera



	∅ mm	€		
1547KP/1	9-11-12,5	32,00	1	015470106
1547KP/2	5-6-8	20,00	1	015470206

1547P

prolunghe esagonali



	L mm	∅ mm	€	
1547 P/1	205	1547/1	6,00	1 015470101
1547 P/2	102	1547/2	4,50	1 015470201

1547PC/2

prolunghe tonde corte



	L mm	∅ mm	€	
1547PC/2	42	1547/2	2,10	1 015470202

1547PL/2

prolunghe tonde lunghe

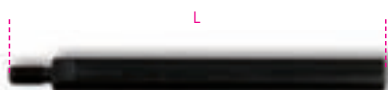

	L mm	∅ mm	€	
1547PL/2	106	1547/2	3,20	1 015470203

1550/1

compressore pneumatico per molle ammortizzatori Mac Pherson ed equivalenti

- Pressione d'utilizzo 6Bar - Max. 8Bar
- Consumo aria medio 225 l/min

CE



1550/1 € 1.950,00 1 015500001

1550/PS

piattello di supporto e contenimento ammortizzatore per 1550/1



1550/PS € 54,00 1 015500057

1550/SR...

staffa di ricambio per 1550/1

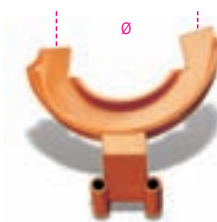

	∅ mm	€		
1550/SR90	50÷90	125,00	1	015500050
1550/SR150	90÷150	125,00	1	015500051
1550/SR175	120÷175	125,00	1	015500052
1550/SR205	130÷205	125,00	1	015500053

1550/MRC

staffa per ammortizzatori Mercedes W203, W209 (classe C e E)



1550/MRC € 335,00 1 015500061

1555DS

pressore per molle ammortizzatori MacPherson ed equivalenti

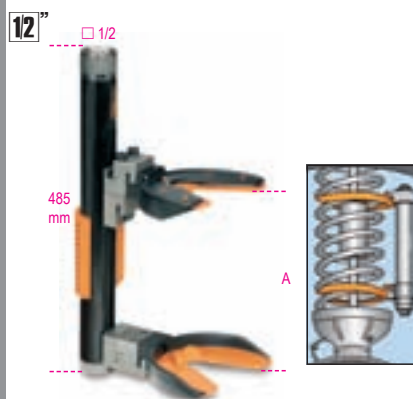

A	∅	€		
min÷Max mm	min÷Max mm			
50÷350	80÷200	1.050,00	1	015550000

1555S/MRC-C

staffa per ammortizzatori Mercedes W203, W209 (Classe C e E) per 1555DS e 1555/QS



1555S/MRC-C € 180,00 1 015550301



1555S/BMW-RNT

staffa per ammortizzatori
BMW E39, E46 e Renault Megane II
per 1555DS e 1555/QS



1555S/BMW-RNT € 230,00 1 015550303

1555/QS

pressore per molle ammortizzatori
Mac Pherson ed equivalenti

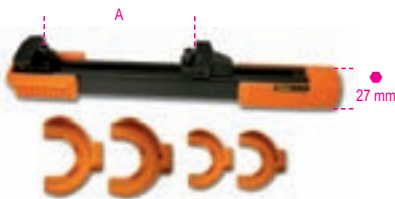

A	Ø	€	1	015550005
min+Max	min+Max			
mm	mm			
70+300	90+205	740,00	1	015550005

1555C

pressore telescopico per molle ammortizzatori
con 4 staffe e barra di torsione

12



A	Ø	N	t	€	1	015550202
min+Max	min+Max					
mm	mm					
80+225	90+160	25000	8,5	775,00	1	015550202

1556/1A

pressore per molle ammortizzatori

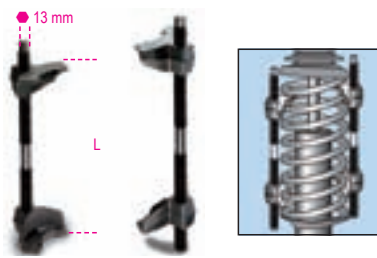

min L max
mm
65+320 € 175,00 1 015560101

1556/2A

pressore per molle ammortizzatori

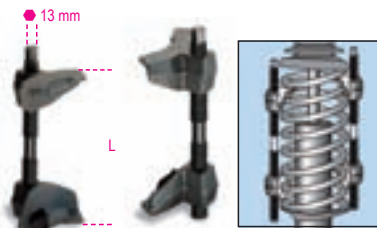

min L max
mm
65+200 € 175,00 1 015560102

1556/3A

pressore per molle ammortizzatori

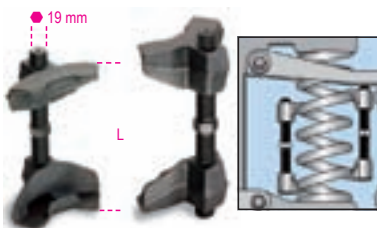

min L max
mm
87+170 € 175,00 1 015560103

1557

chiavi a bussola Macchina
per perni balestre Truck

3/4



L	L1	€	1	015570137
mm	mm			
37	28	65,00	1	015570137
46	34	66,00	1	015570146
56	34	71,00	1	015570156

1557V

chiave a bussola Macchina
per perni balestre Truck Volvo



mm 27 € 33,00 1 015570299

1557/S3

serie di 3 chiavi
per ghiera ammortizzatori

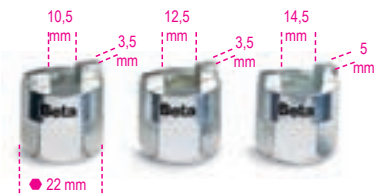

1557/S3 € 75,00 1 015570010

1559

estrattore per snodi sferici



	A max	Ø	€	1	015590001
	mm	mm			
1559/22	50	18+22	68,00	1	015590001
1559/36	90	36	280,00	1	015590036
1559/45	115	45	440,00	1	015590045

1559V/8T

vite idraulica per estrattore snodi sferici
1559/36 e 1559/45



Nm 80000 t 8 € 220,00 1 015590145

1560/1 - 1560/2

estrattori per snodi sferici
modello professionale

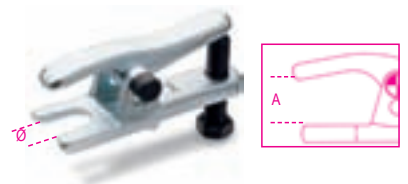

	A	min+max	Ø	€	1	015600001
	mm	mm	mm			
1560/1	12+50	20	117,00	1	015600001	
1560/2	60+85	20	145,00	1	015600002	

1560A

estrattore per snodi sferici



1560A € 205,00 1 015600601

Beta



1561/...

estrattori per snodi sferici

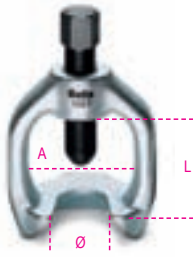

	L mm	A mm	Ø mm	€		
1561/1	39	36,6	18	47,00	1	015610001
1561/2	47	45,7	25	69,00	1	015610002
1561/3	63	62	30	86,00	1	015610003
1561/4	75	63	40	130,00	1	015610004

1562D

estrattore per snodi sferici

Fornito con 2 viti per l'estrazione di giunti sospensione e sterzo



A max mm	Ø mm	● mm	L mm	€		
50	39	26	155	232,00	1	015620239

1565/1 - 2 - 3

estrattori a percussione per snodi sferici



	Ø mm	L1 mm	€		
1565/1	18	65	58,00	1	015650001
1565/2	23	65	62,00	1	015650002
1565/3	30	88	68,00	1	015650003

1566N

attrezzo per smontaggio/montaggio braccetti sterzo



Ø x L mm	○ mm	□	€		
28÷35 x 400	27	12"	87,00	1	015660005
35÷45 x 190	27	-	84,00	1	015660008
35÷45 x 400	27	12"	95,00	1	015660010

1566GO

estrattore per giunti omocineticici

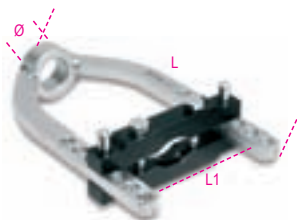

L mm	L1 mm	Ø mm	€		
250	100	29,5	325,00	1	015660051

1568/C15

kit per smagliatura e ribaditura catene



1568/C15	€		
	250,00	1	015680015

420x185x60 mm

1568R/CS3

cacciaspina per smagliacatene



1568R/CS3	€		
	43,00	1	015680503

1569

assortimento di utensili per l'estrazione e l'introduzione dei silent block ponte posteriore, paraoli albero motore e cuscinetti ruota

- le boccole possono essere utilizzate sia direttamente sul veicolo che alla pressa idraulica
- estrazione diretta con chiave
- facilità di utilizzo, non servono macchine pneumatiche o idrauliche
- il kit comprende:
4 barre filettate: M10-M12-M14-M16
4 rondelle
boccole per diametri da 44 a 82 mm



1569	€		
	610,00	1	015690010

420x185x60 mm - 12 kg

1570/3

martinetti idraulici per estrattori



t	L mm	L1 mm	● mm	€		
30	243	36	19	163,00	1	015700003

1580/8I

estrattore universale idraulico a due griffe

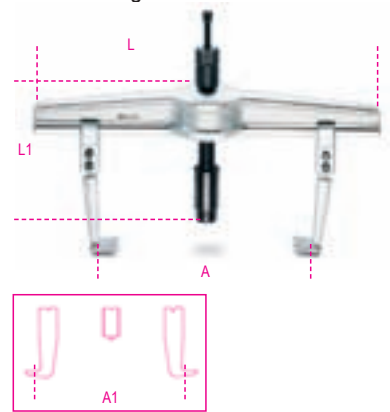

1580/8I	€		
	1.100,00	1	015800008

	A min+max mm	L mm	L1 mm	A1 min+max mm	N Max
1580/8I	170÷640	715	280	260÷715	180000

1580GL

griffe tipo lungo per estrattori 1580/8I



	L mm	€		
1580GL/8A	300	133,00	1	015800227
1580GL/8B	400	146,00	1	015800228
1580GL/8C	500	185,00	1	015800229

1585/5I - 6I - 7I

estrattori a tre griffe per azionamento idraulico

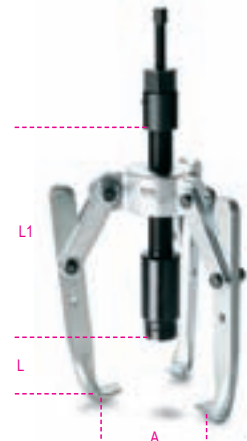

	€		
1585/5I	805,00	1	015850005
1585/6I	845,00	1	015850006
1585/7I	905,00	1	015850007

	A min+max mm	L1 mm	L mm	N Max
1585/5I	50÷350	135	280	150000
1585/6I	50÷350	235	280	150000
1585/7I	50÷350	335	280	150000

1585GI/5 - 6 - 7

griffe per estrattori idraulici
1585/5I - 1585/6I - 1585/7I

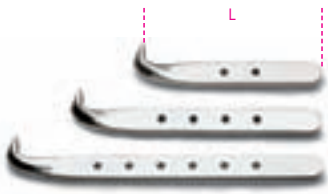

L mm	€		
1585GI/5 135	126,00	1	015850205
1585GI/6 235	158,50	1	015850206
1585GI/7 335	197,00	1	015850207

1589VI

vite idraulica per estrattori 1580/8I
e 1585/5I - 1585/6I - 1585/7I

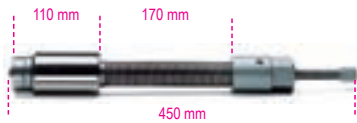

	€		
1589VI	473,00	1	015890001

1589PI/50 - 100 - 150

prolunghe per vite idraulica



L mm	L1 mm	€		
1589PI/50 50	70	44,00	1	015890005
1589PI/100 100	120	51,00	1	015890010
1589PI/150 150	170	56,00	1	015890015

1590

morsetti standard



A max mm	L1 mm	€		
60	55	18,50	2	015900305
80	65	24,00	2	015900307
100	65	29,50	2	015900310
120	85	33,50	2	015900312
150	95	48,00	2	015900315

1591

strettoi a vite

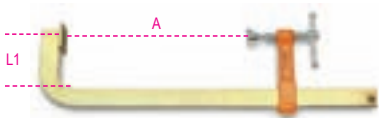

A mm	A max mm	L1 mm	€		
200	200	80	19,00	2	015910020
300	310	85	24,00	2	015910030
400	410	85	25,00	2	015910040
500	500	95	33,00	2	015910050
600	600	95	34,50	2	015910060
800	800	95	40,00	2	015910080
1000	1000	110	50,00	2	015910100

1593

serragianti a vite

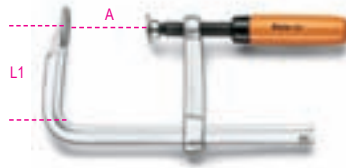

A mm	A max mm	L1 mm	€		
160	170	80	24,50	2	015930016
200	240	100	36,00	2	015930020
300	320	145	53,00	2	015930030

1594

serragianti a leva

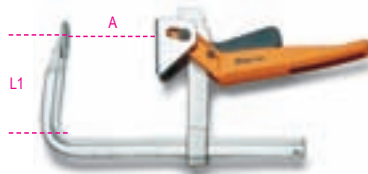

A mm	A max mm	L1 mm	€		
200	240	145	78,00	1	015940020
250	290	145	85,00	1	015940025
300	340	145	92,00	1	015940030
400	430	150	98,00	1	015940040
500	530	150	101,00	1	015940050
600	630	150	105,00	1	015940060

1594A

serragianti in alluminio

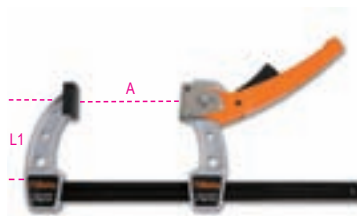

A mm	A max mm	L1 mm	€		
100	110	80	28,00	1	015940110
200	210	80	31,00	1	015940125
300	320	80	36,00	1	015940130

1594A/RG

gommino per serragianti 1594A



	€		
1594A/RG	2,50	2	015940199

1595

serragianti a vite

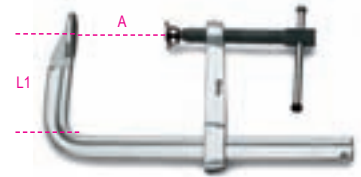

A mm	A max mm	L1 mm	€		
200	230	100	38,00	2	015950020
250	270	120	42,00	2	015950025
300	330	120	53,00	2	015950030
400	420	120	61,00	2	015950040
500	520	125	64,00	2	015950050
600	620	125	68,00	2	015950060
800	820	125	80,00	1	015950080
1000	1030	125	89,00	1	015950100

1596

morsetti reversibili in nylon / fibra di vetro



A max mm	L1 mm	€		
150	60	24,50	1	015960115
300	60	26,50	1	015960130
450	60	29,50	1	015960145

1596/RG

coppia di gommini per morsetti 1596



	€		
1596/RG	2,50	1	015960199

1599F

morso parallelo da banco forgiate

con piano e guide temprate



L1 mm	BxH mm	Ø mm	€		
100	92x46	11	235,00	1	015990100
125	108x54	13	295,00	1	015990125
150	125x62	13	415,00	1	015990150
175	140x70	15	555,00	1	015990175

1599P

morse parallele da banco forgiate

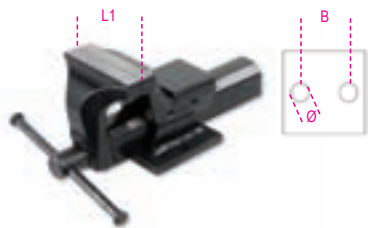

L1 mm	B mm	Ø mm	€		
100	92	11	205,00	1	015990000
125	108	13	240,00	1	015990025
150	130	15	335,00	1	015990050

1599B

basi girevoli per morse 1599P



	1599P	€		
1599B100	100	85,00	1	015990810
1599B125	125	95,00	1	015990812
1599B150	150	115,00	1	015990815

1599T

morse parallele da trapano

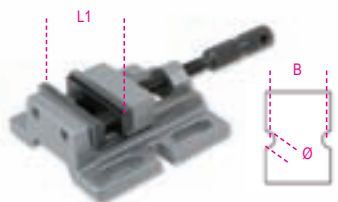

L1 mm	B mm	Ø mm	€		
80	111	11	115,00	1	015990480
100	120	13	145,00	1	015990500

1599G

coppie di copriganasce in alluminio



A mm	€		
100	38,00	1	015990910
125	41,00	1	015990912
150	44,00	1	015990915
180	49,00	1	015990917

1601/PC

pinza a cricchetto per capicorda telefonia e trasmissione dati



RJ11-RJ12-RJ45 € 45,00 2 016010011

1602

pinza per capicorda preisolati modello leggero

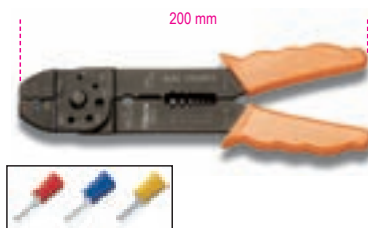

mm² 0,75÷6 € 11,00 5 016020001

1602/C9T

pinza per capicorda 1602 con assortimento di 450 capicorda



1602/C9T € 121,00 1 016020013

	n.
1602	1
1620 R/6,3	50
1620 B/6,3	50
1620 G/6,3	50
1624 R/6,3	50
1624 B/6,3	50
1624 G/6,3	50
1628 R/1,6	50
1628 B/2,3	50
1628 G/3,6	50

420x350x35 mm - 1,5 kg

1602A

pinza per capicorda preisolati modello standard



mm² 0÷6 € 43,00 2 016020005

1603

pinza per capicorda non isolati modello leggero

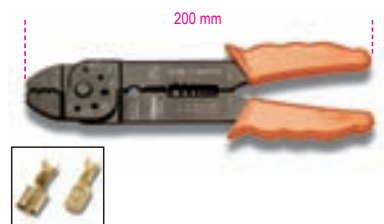

mm² 1,25÷5,5 € 11,00 5 016030001

1603A

pinza per capicorda non isolati chiusi modello standard

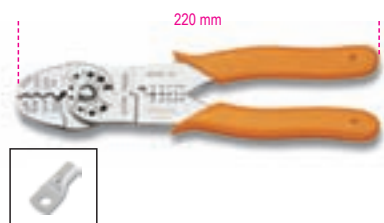

mm² 0÷8 € 43,00 2 016030005

1603B

pinza per capicorda non isolati aperti modello standard

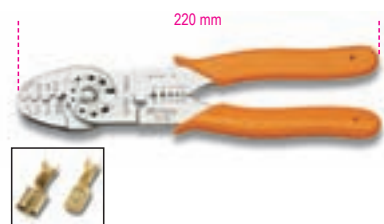

mm² 0÷8 € 42,00 2 016030010

Beta

1604

pinza autobloccante per capicorda preisolati

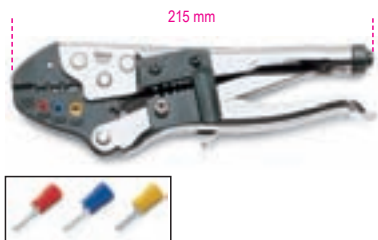

mm² 0,5÷6 € 74,00 1 016040001

1604/C9T

pinza per capicorda 1604 con assortimento di 450 capicorda



1604/C9T € 184,00 1 016040013

	n.
1604	1
1620 R/6,3	50
1620 B/6,3	50
1620 G/6,3	50
1624 R/6,3	50
1624 B/6,3	50
1624 G/6,3	50
1628 R/1,6	50
1628 B/2,3	50
1628 G/3,6	50

420x350x35 mm - 2 kg

1605

pinza autobloccante per capicorda non isolati

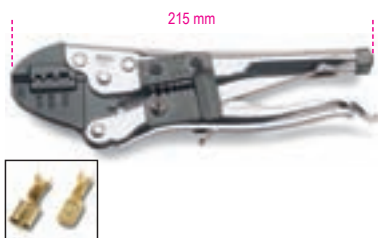

mm² 0,5÷6 € 74,00 1 016050001

1606

pinza a grande effetto per capicorda a tubetto



mm² 0,5÷6 € 250,00 1 016060001

1606A

pinza per capicorda a tubetto



mm² 0,5÷6 € 69,00 1 016060010
 1606A16 6÷16 € 69,00 1 016060016

1606A/C9

Pinza per capicorda a tubetto 1606A6 con assortimento di 450 capicorda



1606A/C9 € 125,00 1 016060100

	n.
1606A	1
1632 W/0,5K	50
1632 N/1,5K	100
1632 B/2,5K	100
1632 G/4K	100
1632 Y/6K	100

420x350x35 mm - 2,5 kg

1607

pinza a grande effetto per connettori BNC per cavi coassiali RG 58, RG 59, RG 62, RG 71

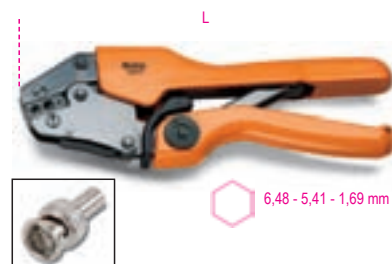

L mm 220 A mm 73 B mm 19 € 215,00 1 016070001

1608

pinza per capicorda preisolati, con regolatore di pressione

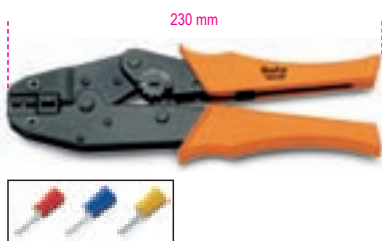

mm² 0,5÷6 € 88,00 1 016080001

1608/C9T

pinza per capicorda 1608 con assortimento di 450 capicorda



1608/C9T € 198,00 1 016080013

	n.
1608	1
1620 R/6,3	50
1620 B/6,3	50
1620 G/6,3	50
1624 R/6,3	50
1624 B/6,3	50
1624 G/6,3	50
1628 R/1,6	50
1628 B/2,3	50
1628 G/3,6	50

420x350x35 mm - 2 kg



1608A

pinza a grande effetto
per capicorda preisolati



mm ²	€	1	016080005
0,75÷6	168,00		

1609

pinza per capicorda non isolati

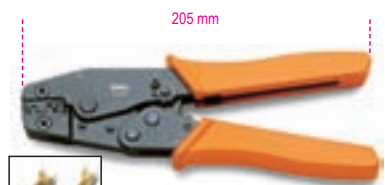

mm ²	€	1	016090001
0,5÷2,5	88,00		

1609A

pinza a grande effetto
per capicorda non isolati



mm ²	€	1	016090005
0,5÷6	332,00		

1609B

pinza per capicorda non isolati



L mm	mm ²	€	1	016090101
600	10÷120	217,00		

1609C/C5

pinza oleodinamica per capicorda

crimpature esagonali



mm ²	€	1	016090210
50÷240	1.390,00		

500x300x110 mm - 4 kg

1609M

coppia di matrici per 1609C

crimpature esagonali



mm ²	€	1	016090221
1609M/16 10-16	51,00		
1609M/35 25-35	51,00		
1609M/70 50-70	51,00		
1609M/120 95-120	51,00		
1609M/150 150	51,00		
1609M/185 185	51,00		
1609M/240 240	51,00		

1610

terminali con attacco tondo

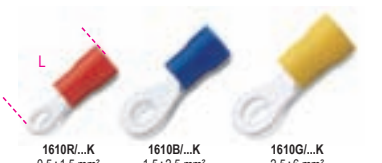

D mm	mm ²	L mm	€	1	016100104
1610R/4K 4	0,5-1,5	17	13,30		
1610R/5K 5	0,5-1,5	20	13,30		
1610B/5K 5	1,5-2,5	22	15,70		
1610B/6K 6	1,5-2,5	27	20,40		
1610B/8K 8	1,5-2,5	27	20,40		
1610G/6K 6	2,5-6	31	30,00		
1610G/8K 8	2,5-6	34	36,50		

I prezzi indicati sono relativi a 100 pezzi

1614

terminali a puntale



1614R/1,9K 0,5+1,5 mm²
1614B/1,9K 1,5+2,5 mm²
1614G/2,8K 2,5+6 mm²

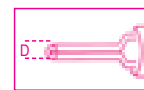

D mm	mm ²	L mm	€	1	016140101
1614R/1,9K 1,9	0,5-1,5	21	15,70		
1614B/1,9K 1,9	1,5-2,5	21	18,00		
1614G/2,8K 2,8	2,5-6	25	35,50		

I prezzi indicati sono relativi a 100 pezzi

1616

terminali cilindrici maschio



1616R/4K 0,5+1,5 mm²

D mm	mm ²	L mm	€	1	016160104
1616R/4K 4	0,5-1,5	21	14,50		

I prezzi indicati sono relativi a 100 pezzi

1618

terminali cilindrici femmina

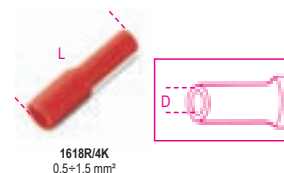

1618R/4K 0,5+1,5 mm²

D mm	mm ²	L mm	€	1	016180104
1618R/4K 4	0,5-1,5	24	18,00		

I prezzi indicati sono relativi a 100 pezzi

1620

raccordi maschio



1620R/6,3K 0,5+1,5 mm²
1620B/6,3K 1,5+2,5 mm²
1620G/6,3K 2,5+6 mm²

HxS 6,3x0,8 mm
HxS 6,3x0,8 mm
HxS 6,3x0,8 mm

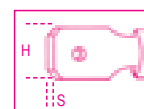

mm ²	L mm	€	1	016200101
1620R/6,3K 0,5-1,5	22	13,30		
1620B/6,3K 1,5-2,5	22	13,30		
1620G/6,3K 2,5-6	22	15,70		

I prezzi indicati sono relativi a 100 pezzi



1622

raccordi femmina



1622R/2,8K 0,5+1,5 mm ²	1622B/6,3K 1,5+2,5 mm ²	1622G/6,3K 2,5+6 mm ²
HxS 2,8x0,5 mm	HxS 6,3x0,8 mm	HxS 6,3x0,8 mm

1622R/6,3K 0,5+1,5 mm ²
HxS 6,3x0,8 mm

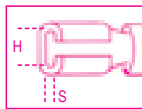

	mm ²	L mm	€		
1622R/2,8K	0,5-1,5	20	12,10	1	016220101
1622R/6,3K	0,5-1,5	22	15,70	1	016220103
1622B/6,3K	1,5-2,5	22	17,00	1	016220106
1622G/6,3K	2,5-6	22	18,00	1	016220108

I prezzi indicati sono relativi a 100 pezzi

1624

raccordi femmina isolati



1624R/6,3K 0,5+1,5 mm ²	1624B/6,3K 1,5+2,5 mm ²	1624G/6,3K 2,5+6 mm ²
HxS 6,3x0,8 mm	HxS 6,3x0,8 mm	HxS 6,3x0,8 mm

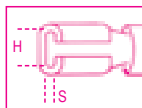

	mm ²	L mm	€		
1624R/6,3K	0,5-1,5	23	20,40	1	016240102
1624B/6,3K	1,5-2,5	24	20,40	1	016240104
1624G/6,3K	2,5-6	24	22,00	1	016240105

I prezzi indicati sono relativi a 100 pezzi

1628

connettori di linea



1628R/1,6K 0,5+1,5 mm ²	1628B/2,3K 1,5+2,5 mm ²	1628G/3,6K 2,5+6 mm ²
---------------------------------------	---------------------------------------	-------------------------------------



	D mm	L mm	€		
1628R/1,6K	1,6	0,5-1,5	25	15,70	1 016280101
1628B/2,3K	2,3	1,5-2,5	26	17,00	1 016280102
1628G/3,6K	3,6	2,5-6	26	26,00	1 016280103

I prezzi indicati sono relativi a 100 pezzi

1630

connettori rapidi



1630R/K 0,5+1,5 mm ²	1630B/K 1,5+2,5 mm ²
------------------------------------	------------------------------------

	mm ²	L mm	€		
1630R/K	0,5-1,5	20	26,00	1	016300101
1630B/K	1,5-2,5	20	26,00	1	016300102

I prezzi indicati sono relativi a 100 pezzi

1632

terminali a tubetto



	mm ²	L mm	€		
1632W/0,5K	0,5	14	4,00	1	016320005
1632G/0,75K	0,75	14	4,00	1	016320007
1632R/1K	1	14	4,00	1	016320010
1632N/1,5K	1,5	15	4,00	1	016320015
1632B/2,5K	2,5	15	5,00	1	016320025
1632G/4K	4	17	7,50	1	016320040
1632Y/6K	6	20	9,50	1	016320060

I prezzi indicati sono relativi a 100 pezzi

1634

terminali doppi a tubetto



	mm ²	L mm	€		
1634W/0,5K	0,5	15	7,00	1	016340005
1634G/0,75K	0,75	15	7,00	1	016340007
1634R/1K	1	15	7,00	1	016340010
1634N/1,5K	1,5	16	8,00	1	016340015
1634B/2,5K	2,5	19	9,00	1	016340025
1634G/4K	4	23	21,00	1	016340040
1634Y/6K	6	26	25,00	1	016340060

I prezzi indicati sono relativi a 100 pezzi

1639NS-N

nastro isolante nero



L m	€		
25	4,00	10	016390025

1639S

sonda tirafili in nylon

con teste intercambiabili



L m	Ø mm	€		
10	4	14,50	1	016390010

1640K

punzonatrice oleodinamica con 4 fustelle

forature tonde
22,5-25,5-32,5-55,5 mm



1640K	€		
	1.225,00	1	016400001

470x400x100 mm

1640

punzonatrice per lamiera



1640	€		
	795,00	1	016400100

1640A

adattatore per 1640



1640A	€		
	8,00	1	016400080

1640P

perno filettato per 1640



	Ø mm	€		
1640P/9	9,5	24,00	1	016400088
1640P/19	19	29,00	1	016400089

1640Q

fustelle quadre per 1640
con perno incluso



1640Q/45	mm	€		
	45x45	520,00	1	016400065

1640T

fustelle tonde per 1640

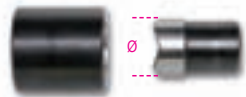

	Ø mm	€		
1640T/22,5	22,5	51,00	1	016400022
1640T/25,5	25,5	66,00	1	016400025
1640T/32,5	32,5	79,00	1	016400032
1640T/55,5	55,5	102,00	1	016400055

1650

calibro a corsoio
lettura ventesimale



UNI/ISO 3599 DIN 862

1650	€ 44,00	1	016500001
------	---------	---	-----------

1650FD

calibro a corsoio per dischi freni
lettura decimale

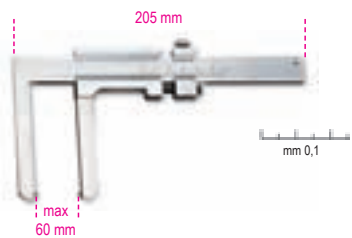

1650FD	€ 175,00	1	016500050
--------	----------	---	-----------

1650FT

calibro a corsoio per tamburi freni
lettura ventesimale



	A max mm	L mm	€	
1650FT	350	438	295,00	1 016500060
1650FT/2	500	550	550,00	1 016500070

1651DGT

calibro digitale a corsoio
lettura centesimale



DIN 862

1651DGT	€ 97,00	1	016510111
---------	---------	---	-----------

1652

calibro a corsoio con comparatore
lettura cinquantessimale



DIN 862

1652	€ 99,00	1	016520016
------	---------	---	-----------

1654

calibri a corsoio
lettura cinquantessimale



UNI/ISO 6906 DIN 862

A max mm	L mm	€	
200	330	225,00	1 016540020
300	410	298,00	1 016540030

1654DGT

calibro digitale a corsoio
lettura centesimale

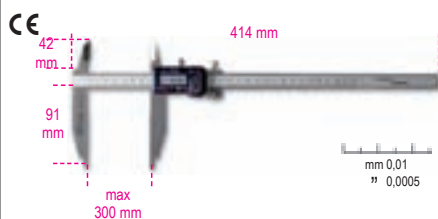

DIN 862

1654DGT	€ 490,00	1	016540111
---------	----------	---	-----------

1656

calibri a corsoio di profondità
lettura cinquantessimale



DIN 862

A max mm	L mm	€	
200	260	98,00	1 016560020
300	360	140,00	1 016560030

1657DGT/2

calibro a corsoio di profondità digitale
lettura centesimale

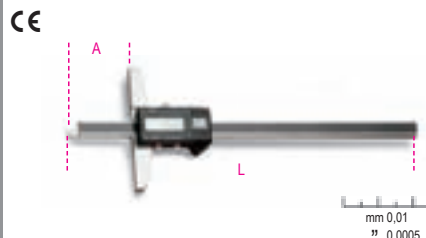

DIN 862

A max mm	L mm	€	
1657DGT/2	200 270	250,00	1 016570002

1658/...

micrometri per esterni
lettura centesimale



DIN 863/II

A mm	€		
1658/25	0÷25	53,00	1 016580025
1658/50	25÷50	58,00	1 016580050
1658/75	50÷75	67,00	1 016580075
1658/100	75÷100	79,00	1 016580100

1658/C4

assortimento di 4 micrometri 1658



1658/C4	€ 230,00	1	016580001
---------	----------	---	-----------

1658/25	0÷25 mm
1658/50	25÷50 mm
1658/75	50÷75 mm
1658/100	75÷100 mm

365x245x35 mm - 2,5 kg

1658DGT

micrometri digitali per esterni
lettura millesimale

CE



DIN 863

	A mm	€		
1658DGT/25	0÷25	275,00	1	016580325
1658DGT/50	25÷50	315,00	1	016580350

1658SP/1

supporto per micrometro
in ghisa



	€		
1658SP/1	34,00	1	016580910

1659

misuratore di spessore
con comparatore
lettura centesimale

C = Campo di comparazione

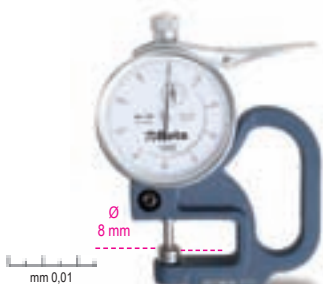

	C mm	€		
1659	0÷10	155,00	1	016590001

1662/1 - 1662/2

comparatori
lettura centesimale

C = Campo di comparazione



	C mm	€		
1662/1	0÷5	68,00	1	016620001
1662/2	0÷10	85,00	1	016620010

1662DGT

comparatore digitale
lettura centesimale
C = Campo di comparazione

CE



DIN 878

	C mm	€		
1662DGT	0÷12,5	218,00	1	016620310

1662AN

comparatore a tastatore orientabile
lettura centesimale

C = Campo di comparazione



DIN 2270

	C mm	€		
1662AN	0÷0,8	168,00	1	016620200

1662SP0

supporto a base magnetica



	€		
1662SP0	57,00	1	016620800

1662SP2

supporto a base magnetica
snodato



	€		
1662SP2	95,00	1	016620910

1666A

squadre a cappello
in acciaio inossidabile
rettificate e lappate



DIN 875/0

L mm	L1 mm	€		
100	70	83,00	1	016660110
150	100	114,00	1	016660115
200	130	159,00	1	016660120
250	170	204,00	1	016660125
300	200	265,00	1	016660130

1668A

squadre a cappello
in acciaio normalizzato
rettificate



DIN 875/2

L mm	L1 mm	€		
100	70	23,00	2	016680110
150	100	34,50	2	016680115
200	130	44,00	2	016680120
250	165	62,00	1	016680125
300	176	74,00	1	016680130

Beta

1670

squadre semplici
in acciaio, rettificata



L mm	L1 mm	€		
100	70	8,50	3	016700010
150	100	10,00	3	016700015
200	130	12,00	3	016700020
250	160	14,00	3	016700025
300	180	16,00	3	016700030
400	200	22,00	2	016700040
500	250	25,00	2	016700050
600	300	31,00	2	016700060
750	375	40,00	1	016700080
1000	500	45,00	1	016700099

1670A

squadre a cappello
in acciaio, rettificata



L mm	L1 mm	€		
100	70	12,50	3	016700110
150	100	14,50	3	016700115
200	130	17,50	3	016700120
250	160	20,50	3	016700125
300	180	26,00	3	016700130
400	200	34,00	2	016700140
500	250	42,00	2	016700150
600	300	55,00	2	016700160
800	400	70,00	1	016700180
1000	500	80,00	1	016700199

1672

squadra falsa
a lama orientabile e scorrevole
lama e base in acciaio

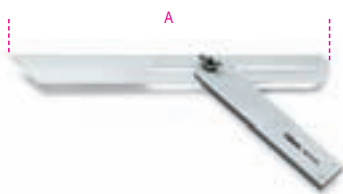

A mm	€		
300	39,00	2	016720030

1672A

squadra falsa
a lama orientabile e scorrevole
lama in acciaio cromata
base in alluminio

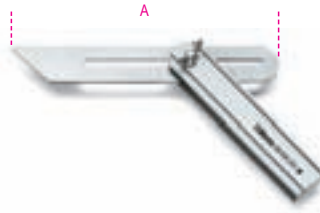

A mm	€		
200	21,00	3	016720120
300	24,00	3	016720130

1674A

squadre per falegnami
lama in acciaio, base in alluminio
doppia scala millimetrata

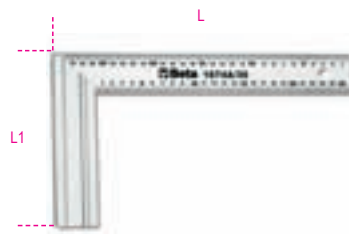

L mm	L1 mm	€		
300	169	18,00	2	016740130
400	214	22,00	2	016740140

1676

goniometri semplici
in acciaio

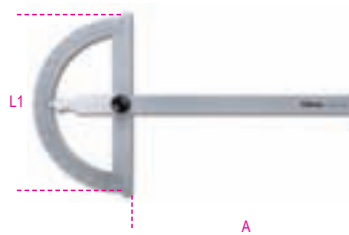

A mm	A mm	L1 mm	G mm	€		
120	120	80	1°	28,00	2	016760012
150	165	120	1°	33,00	2	016760015
200	210	150	1°	40,00	2	016760020
300	310	200	1°	53,00	1	016760030

1678/C3

rapportatore d'angoli
in acciaio inossidabile

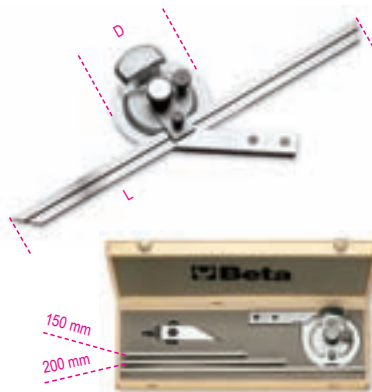

L Max mm	D mm	€		
300	70	222,00	1	016780030

1679

calibro a tracciare con rotella
in acciaio inossidabile
lettura decimale

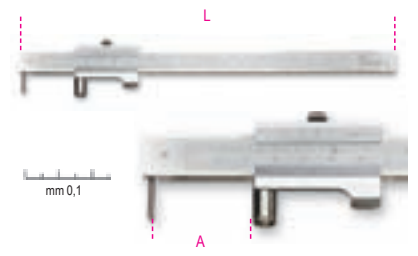

L mm	A Max mm	€		
235	200	63,00	1	016790020

1680

compasso a verga
corpo e punte di tracciatura
in acciaio temprato

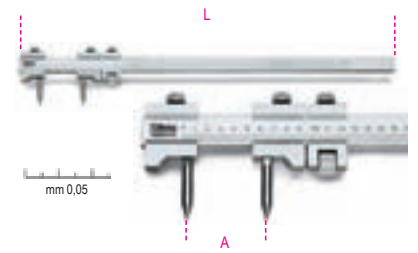

L mm	A Max mm	€		
660	500	222,00	1	016800050

1680A

compassi di precisione per interni



L mm	A Max mm	€		
150	144	14,00	2	016800115
200	200	17,00	2	016800120
250	245	21,00	1	016800125
300	300	24,00	1	016800130

1680B

compassi di precisione per esterni



L mm	A Max mm	€		
150	155	14,00	2	016800215
200	190	17,00	2	016800220
250	235	21,00	1	016800225
300	280	24,00	1	016800230

1680C

compassi di precisione per tracciatori
punte diritte in acciaio temprato



L mm	A Max mm	€		
150	138	14,00	2	016800315
200	190	17,00	2	016800320
250	235	21,00	1	016800325
300	280	24,00	1	016800330

1682

righe flessibili graduate
in acciaio inossidabile



L mm	€		
150	2,10	5	016820015
200	2,30	5	016820020
250	2,80	5	016820025
300	3,50	5	016820030
500	10,00	2	016820050
1000	21,00	2	016820100

1683

righe semirigide graduate
in acciaio inossidabile

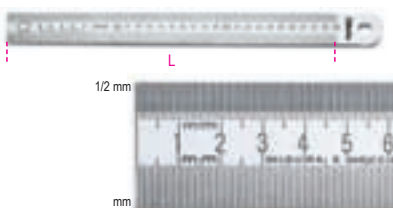

L mm	€		
300	8,50	5	016830030
500	12,00	2	016830050
1000	34,00	2	016830100
1500	70,00	1	016830150
2000	91,00	1	016830200

1685/C7

assortimento di 7 strumenti
per misurare e tracciare



1685/C7 € 207,00 1 016850110

1650	160 mm
1658/25	0+25 mm
1670	100 mm
1680C	150 mm
1682	150 mm
1688BC	165 mm
1688BC/R	

320x210x37 mm - 1,2 kg

1687A

punta di precisione piegata a 90°
con impugnatura



1687A L mm 153 L1 mm 80 € 4,70 1 016870120

1687AC

punta di precisione piegata corta
con impugnatura

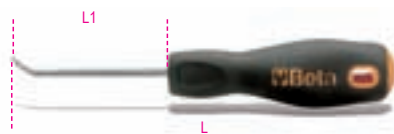

1687AC L mm 153 L1 mm 80 € 4,70 1 016870125

1687D

punta di precisione diritta
con impugnatura



1687D L mm 153 L1 mm 80 € 4,70 1 016870110

1687U

punta di precisione ad uncino
con impugnatura

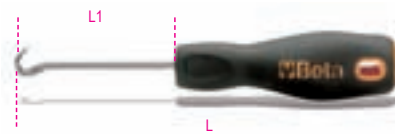

1687U L mm 153 L1 mm 80 € 4,70 1 016870115

1687/S4

serie di 4 punte di precisione
con impugnatura



1687/S4 € 18,80 1 016870150
1687A-1687AC
1687D-1687U

1688

punta per tracciare
in acciaio temprato



1688 L mm 250 Ø mm 2 € 5,50 5 016880020

1688A

punta per tracciare in acciaio temprato
con punte in carburo di tungsteno



1688A L mm 200 Ø mm 4 € 11,50 5 016880120

1688BC

punta per tracciare a penna
in acciaio temprato cromato



1688BC L mm 148 Ø mm 2 € 21,00 1 016880200

1688BC/R

punta di ricambio per 1688BC



1688BC/R € 9,60 1 016880210



1688M

matita per falegnami



1688M	L mm	€	50	016880880
	180	0,70		

1690Fmetro pieghevole in fibra di vetro
classe di precisione III

1690F/2	L m	S mm	€	5	016900220
	2	17	8,50		

1690Lmetro pieghevole in legno di betulla
classe di precisione III

1690L/2	L m	S mm	€	5	016900200
	2	17	9,50		

1691BGflessometri
cassa bimerale in ABS antiurto
nastro in acciaio
classe di precisione II

Blocco automatico del nastro



1691BG/3	L m	S mm	€	5	016910103
	3	19	9,00		
1691BG/5	5	25	12,00	5	016910105
1691BG/8	8	25	15,00	3	016910108
1691BG/10	10	25	18,00	2	016910110

1692flessometri
cassa bimerale in ABS antiurto
nastro in acciaio
classe di precisione II

1692/2	L m	S mm	€	5	016920052
	2	16	5,50		
1692/3	3	16	7,00	5	016920053
1692/5	5	19	10,00	5	016920055
1692/8	8	25	14,50	5	016920058

1694/Lrotelle metriche
cassa in ABS antiurto
nastro in fibra di vetro ricoperto in PVC
classe di precisione III

1694/L10	L m	S mm	€	1	016940110
	10	13	9,00		
1694/L20	20	13	11,00	1	016940120

1694A/Lrotelle metriche con impugnatura
cassa in ABS antiurto
nastro in fibra di vetro ricoperto in PVC
classe di precisione III

1694A/L30	L m	S mm	€	1	016940230
	30	13	22,00		
1694A/L50	50	13	29,00	1	016940250

1694B/Lrotella metrica con impugnatura
cassa in alluminio
nastro in acciaio smaltato
classe di precisione II

1694B/L	L m	S mm	€	1	016940350
	50	12,5	57,00		

1696livelle in alluminio profilato anodizzato
con file infrangibili
precisione 1 mm/m

L mm	H mm	S mm	€	2	016960002
200	50	19	14,50		
400	50	19	17,00	2	016960004
500	50	19	18,50	2	016960005
600	50	19	20,00	2	016960006
800	50	19	25,00	2	016960008
1000	50	19	28,00	2	016960010

1696Alivelle in alluminio pressofuso
con 1 base rettificata a 2 file infrangibili
precisione 1 mm/m

L mm	H mm	S mm	€	2	016960103
300	43	23	21,00		
400	43	23	22,50	2	016960104
500	43	23	25,00	2	016960105
600	43	23	27,50	2	016960106
800	43	23	44,00	2	016960108
1000	43	23	55,00	2	016960110

1696Blivelle con base magnetica
in alluminio profilato
anodizzato a 2 file infrangibili
precisione 1 mm/m

L mm	H mm	S mm	€	2	016960203
300	49	22	25,50		
400	49	22	27,00	2	016960204
500	49	22	31,50	2	016960205
600	49	22	34,00	2	016960206

1696Dlivelle in alluminio pressofuso con
impugnatura, (tranne la versione da 300 mm)
4 basi rettificate 3 file infrangibili
precisione 1 mm/m

L mm	H mm	S mm	€	2	016960353
300	47	25	20,00		
400	47	25	23,00	2	016960354
500	47	25	25,00	2	016960355
600	47	25	28,50	2	016960356



1696S

stadio in alluminio con impugnatura a due filee infrangibili
precisione 1 mm/m

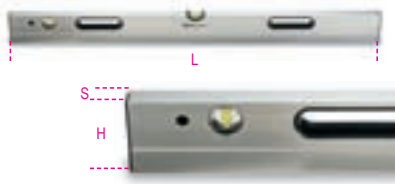

L mm	H mm	S mm	€	Icona	Icona
1500	90	25	75,00	1	016960415
2000	90	25	89,00	1	016960420
2500	90	25	110,00	1	016960425
3000	90	25	125,00	1	016960430

1699L

livella lineare di precisione in ghisa con base prismatica rettificata a 2 filee infrangibili
precisione 0,05 mm/m



DIN 877

1699L	L mm	A mm	€	Icona	Icona
	200	49	225,00	1	016990002

1699L/1

livella lineare di precisione in ghisa con base prismatica rettificata a 2 filee infrangibili
precisione 0,02 mm/m



DIN 877

1699L/1	L mm	A mm	€	Icona	Icona
	200	49	250,00	1	016990005

1699Q

livelle quadre di precisione in ghisa con 2 basi prismatiche e 2 basi piane rettificata a 2 filee infrangibili
precisione 0,05 mm/m



DIN 877

L mm	A mm	€	Icona	Icona
150	40	335,00	1	016990015
200	48	430,00	1	016990020

1700N

punte per edilizia



L mm	S mm	€	Icona	Icona
250	16	10,50	5	017000005
300	16	11,50	5	017000006

1700N/PM

punte per edilizia con paramano



L mm	S mm	€	Icona	Icona
250	16	15,00	2	017000105
300	16	17,00	2	017000106

1701N

scalpelli per edilizia



L mm	A mm	S mm	€	Icona	Icona
250	23	16	11,00	5	017010001
300	23	16	12,00	5	017010003

1701N/PM

scalpelli per edilizia con paramano



L mm	A mm	S mm	€	Icona	Icona
250	23	16	16,00	2	017010101
300	23	16	18,00	2	017010103

1701PMR

paramano per 1700N e 1701N



D mm	L mm	€	Icona	Icona
16	115	7,00	1	017010206

1701NE/...

scalpelli per elettricisti



	SxL mm	€	Icona	Icona
1701NE/3	10x200	6,50	5	017010406
1701NE/4	10x250	7,00	5	017010409

1702N

scalpelli a tagliante extrapiatto



A mm	SxH mm	€	Icona	Icona
50	12x25	15,00	2	017020005
70	12x25	16,00	2	017020007

1702N/PM

scalpelli a tagliante extrapiatto con paramano



A mm	SxH mm	€	Icona	Icona
50	12x25	19,50	2	017020105
70	12x25	21,00	2	017020107



Si raccomanda di raffreddare frequentemente l'utensile durante la riaffilatura.

1702PMR

paramano per 1702N



L mm	€	Icona	Icona
115	5,50	1	017020200

1704

leve piegate per carpentieri

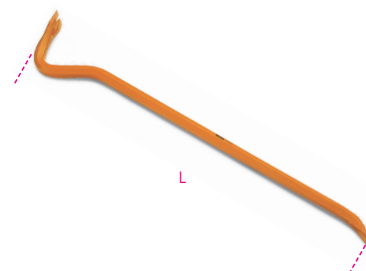

L mm	€	Icona	Icona
500	20,00	2	017040050
600	22,00	2	017040060
800	32,00	2	017040080

1704A

leve con estremità a punta e a scalpello

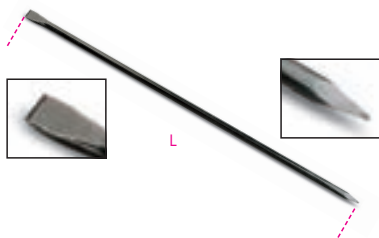

L mm	€	1	017040110
1500	60,00	1	017040110
2000	82,00	1	017040120

1704C

leve con estremità a punta e penna chiusa

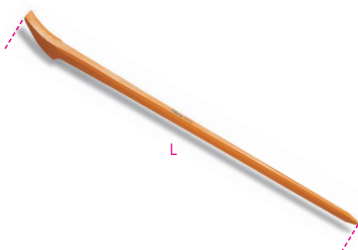

L mm	€	1	017040210
1200	65,00	1	017040210
1400	77,00	1	017040212
1600	95,00	1	017040215

1705

traccialinea in alluminio



L m	€	4	017050001
30	14,50	4	017050001

1705PT

polvere traccialinea



g	€	5	017050025
250	8,00	5	017050025

1706DGT

calibro digitale di profondità per battistrada pneumatici



1706DGT	€	1	017060011
	24,00	1	017060011

1707

contafiletto

Per filetti metrici ISO a 60° e Whitworth a 55°



P (ISO)	W	€	5	017070001
0,25÷6	62÷4x1"	12,00	5	017070001

1707A/1 - 2 - 3

raggimetro

lame concave e convesse, in acciaio



R mm	€	2	017070007
1,0÷7,0	18,50	2	017070007
7,5÷15	20,50	2	017070015
15,5÷25	20,50	2	017070025

1708/8 - 13 - 20

spessimetri



1708/8	€	5	017080008
S = 0,05±0,50 mm	4,00	5	017080008
1708/13	5,00	5	017080013
S = 0,05±1,00 mm	8,50	5	017080020
1708/20	8,50	5	017080020
S = 0,05±1,00 mm			

1709/10 - 1709/18

spaccadadi



L mm	A max mm	€	1	017090010
1709/10	90 17 (M10)	43,00	1	017090010
1709/18	108 25 (M16)	47,00	1	017090018

1710

spaccadadi idraulico



C min mm	C max mm	€	1	017100001
7 (M4)	22 (M14)	180,00	1	017100001

1712E/1 - 2 - 3

flessibili magnetici

F = forza magnetica



L mm	D mm	F kg	€	2	017120011
1712E/1	420	7,5	0,5	22,00	2 017120011
1712E/2	530	15	1,8	29,00	2 017120012
1712E/3	532	19	3,0	37,00	2 017120013

1712E/L1

flessibile magnetico con illuminazione LED

F = forza magnetica

pila: 2X LR48

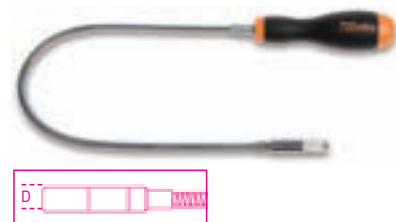

L mm	D mm	F kg	€	2	017120111
1712E/L1	500	11	0,75	31,00	2 017120111

1712TF

magnete telescopico con testa flessibile

• Con pulitore per ugelli lavavetri

F = forza magnetica



L mm	D mm	F kg	€	1	017120600
150÷590	11	1	13,00	1	017120600

1713M

artigli prensili flessibili



L mm	D mm	€	2	017130011
500	7	30,00	2	017130011
1000	7	53,00	1	017130015

1714specchietto rigido
in materiale plastico

1714	L mm	D mm	€	5	017140001
	155	25	2,60		

1715specchietto telescopico articolato
corpo in metallo cromato

1715	L mm	D mm	€	1	017150001
	180=540	30	25,00		

1715FL/A

specchietto flessibile rettangolare



1715FL/A	L mm	A mm	B mm	€	1	017150110
	600	53	90	30,00		

1715FL/Bspecchietto flessibile rettangolare
con illuminazione
pile: 3X AAA

1715FL/B	L mm	A mm	B mm	€	1	017150115
	553	53	90	35,00		

1716R

punteruolo a punta tonda



1716R	L mm	L1 mm	Ø mm	€	5	017160001
	215	100	6	7,00		

1716Q

punteruolo a punta quadra

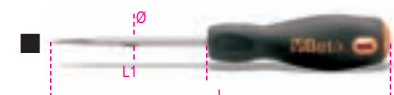

1716Q	L mm	L1 mm	Ø mm	€	5	017160010
	215	100	6	7,00		

1716A

punta angolata per usi generici



1716A	L mm	L1 mm	■ mm	€	3	017160040
	240	125	6	8,00		

1716P

raschietto per guarnizioni

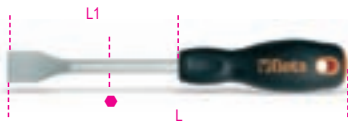

1716P	L mm	L1 mm	● mm	€	3	017160020
	250	125	6	8,00		

1716U

punta ad uncino per usi generici



1716U	L mm	L1 mm	Ø mm	€	3	017160025
	195	80	6	8,00		

1717A

raschietti a due taglienti



L mm	L1 mm	L2 mm	€		
150	70	260	13,50	2	017170015
200	75	310	17,00	2	017170020
250	100	360	19,00	2	017170025

1717B

raschietti a tre taglienti



L mm	L1 mm	L2 mm	€		
150	75	260	12,00	2	017170115
200	85	310	15,00	2	017170120
250	100	360	17,50	2	017170125

1717C

raschietti piatti



L mm	S mm	L1 mm	€		
150	18	270	13,50	2	017170215
200	20	320	15,50	2	017170220
250	25	370	17,50	2	017170225

1717D

raschietto piatto a tagliente frontale

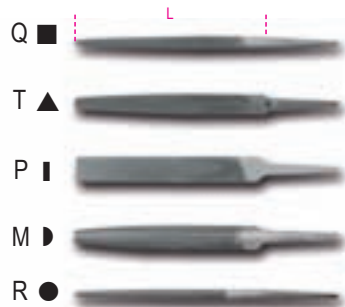

1717D	L mm	S mm	L1 mm	€	2	017170320
	150	23	240	19,00		

1718A6/...lime a taglio mezzodolce 6"
senza impugnatura

L mm	L "	€		
1718A6/Q	150	6	6,50	5 017180021
1718A6/T	150	6	7,80	5 017180023
1718A6/P	150	6	6,30	5 017180025
1718A6/M	150	6	8,80	5 017180027
1718A6/R	150	6	6,30	5 017180029

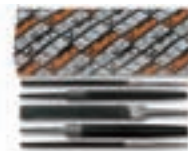

1718A6/S5	€	1	017180030
	35,50		

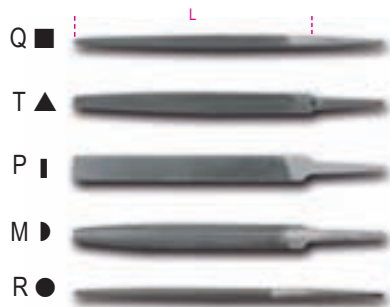
1718A8/...lime a taglio mezzodolce 8"
senza impugnatura

L mm	L "	€		
1718A8/Q	200	8	7,80	5 017180031
1718A8/T	200	8	10,20	5 017180033
1718A8/P	200	8	7,30	5 017180035
1718A8/M	200	8	10,70	5 017180037
1718A8/R	200	8	7,30	5 017180039

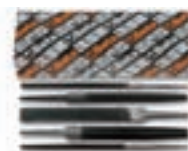

1718A8/S5	€	1	017180040
	43,50		

1718A10/...

lime a taglio mezzodolce 10"
senza impugnatura



	L mm	L "	€	📦	🚚
1718A10/Q	250	10	10,80	5	017180041
1718A10/T	250	10	13,70	5	017180043
1718A10/P	250	10	10,30	5	017180045
1718A10/M	250	10	14,40	5	017180047
1718A10/R	250	10	9,90	5	017180049

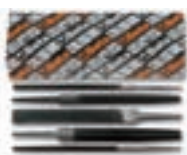

1718A10/S5	€ 59,00	📦 1	🚚 017180050
------------	---------	-----	-------------

1718D6/...

lime a taglio bastardo 6"
senza impugnatura

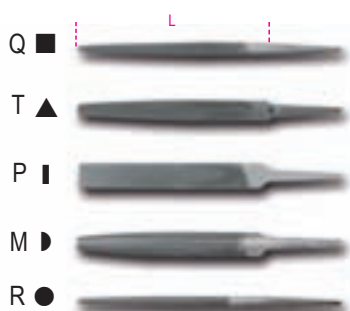

	L mm	L "	€	📦	🚚
1718D6/Q	150	6	6,30	5	017180121
1718D6/T	150	6	7,70	5	017180123
1718D6/P	150	6	6,10	5	017180125
1718D6/M	150	6	8,50	5	017180127
1718D6/R	150	6	6,10	5	017180129



1718D6/S5	€ 34,50	📦 1	🚚 017180130
-----------	---------	-----	-------------

1718D8/...

lime a taglio bastardo 8"
senza impugnatura

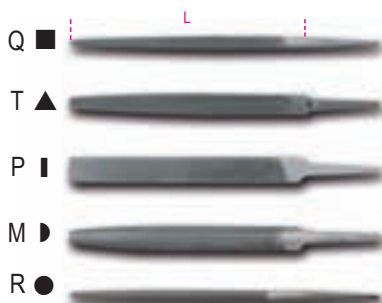

	L mm	L "	€	📦	🚚
1718D8/Q	200	8	7,60	5	017180131
1718D8/T	200	8	9,90	5	017180133
1718D8/P	200	8	7,10	5	017180135
1718D8/M	200	8	10,40	5	017180137
1718D8/R	200	8	7,10	5	017180139



1718D8/S5	€ 42,00	📦 1	🚚 017180140
-----------	---------	-----	-------------

1718D10/...

lime a taglio bastardo 10"
senza impugnatura



	L mm	L "	€	📦	🚚
1718D10/Q	250	10	10,30	5	017180141
1718D10/T	250	10	12,90	5	017180143
1718D10/P	250	10	9,60	5	017180145
1718D10/M	250	10	13,70	5	017180147
1718D10/R	250	10	9,40	5	017180149



1718D10/S5	€ 56,00	📦 1	🚚 017180150
------------	---------	-----	-------------

1719BMA6

lime a taglio mezzodolce 6"
impugnatura in materiale plastico



	L mm	L "	€	📦	🚚
1719BMA6/Q	150	6	9,40	5	017190021
1719BMA6/T	150	6	10,70	5	017190023
1719BMA6/P	150	6	9,60	5	017190025
1719BMA6/M	150	6	12,50	5	017190027
1719BMA6/R	150	6	9,60	5	017190029

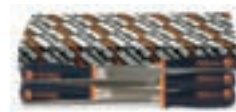

1719 BMA6/S5	€ 52,00	📦 1	🚚 017190030
--------------	---------	-----	-------------

1719BMA8

lime a taglio mezzodolce 8"
impugnatura in materiale plastico



	L mm	L "	€	📦	🚚
1719BMA8/Q	200	8	10,70	5	017190052
1719BMA8/T	200	8	13,10	5	017190054
1719BMA8/P	200	8	10,60	5	017190056
1719BMA8/M	200	8	14,40	5	017190058
1719BMA8/R	200	8	10,60	5	017190060



1719BMA8/S5	€ 59,50	📦 1	🚚 017190070
-------------	---------	-----	-------------

1719BMA10

lime a taglio mezzodolce 10"
impugnatura in materiale plastico



	L mm	L "	€	5	017190071
1719BMA10/Q	250	10	13,70	5	017190071
1719BMA10/T	250	10	16,60	5	017190073
1719BMA10/P	250	10	13,60	5	017190075
1719BMA10/M	250	10	18,10	5	017190077
1719BMA10/R	250	10	13,20	5	017190079

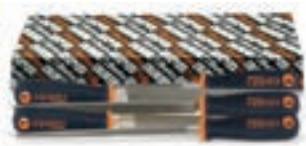

1719BMA10/S5	75,00	1	017190080
--------------	-------	---	-----------

1719BMB/P

lime piatte a taglio universale
impugnatura in materiale plastico

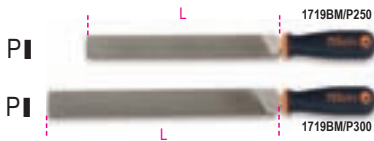

	L mm	L "	€	5	017190152
250	10	20,10	5	017190152	
300	12	24,30	5	017190153	

1719BMC

lime mezzotonde e piatte a mazzo
impugnatura in materiale plastico

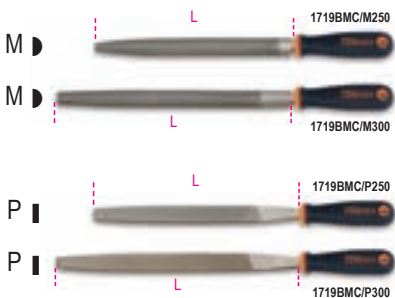

	L mm	L "	€	6	017190252
1719BMC/M250	250	10	13,50	6	017190252
1719BMC/M300	300	12	17,00	4	017190253
1719BMC/P250	250	10	10,60	6	017190262
1719BMC/P300	300	12	13,20	4	017190263

1719BMD6

lime a taglio bastardo 6"
impugnatura in materiale plastico



	L mm	L "	€	5	017190191
1719BMD6/Q	150	6	9,20	5	017190191
1719BMD6/T	150	6	10,50	5	017190193
1719BMD6/P	150	6	9,20	5	017190195
1719BMD6/M	150	6	11,90	5	017190197
1719BMD6/R	150	6	9,20	5	017190199

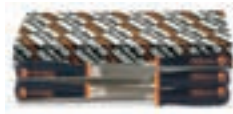

1719BMD6/S5	50,00	1	017190200
-------------	-------	---	-----------

1719BMD8

lime a taglio bastardo 8"
impugnatura in materiale plastico



	L mm	L "	€	5	017190221
1719BMD8/Q	200	8	10,50	5	017190221
1719BMD8/T	200	8	12,70	5	017190223
1719BMD8/P	200	8	10,20	5	017190225
1719BMD8/M	200	8	13,80	5	017190227
1719BMD8/R	200	8	10,20	5	017190229



1719BMD8/S5	57,50	1	017190230
-------------	-------	---	-----------

1719BMD10

lime a taglio bastardo 10"
impugnatura in materiale plastico



	L mm	L "	€	5	017190241
1719BMD10/Q	250	10	13,20	5	017190241
1719BMD10/T	250	10	15,70	5	017190243
1719BMD10/P	250	10	12,70	5	017190245
1719BMD10/M	250	10	17,10	5	017190247
1719BMD10/R	250	10	12,50	5	017190249



1719BMD10/S5	71,00	1	017190250
--------------	-------	---	-----------

1719BM/RR

raspa tonda
impugnatura in materiale plastico



	L mm	L "	€	5	017190351
1719BM/RR	200	8	11,50	5	017190351

1719BM/RL

lima raspa piatta
impugnatura in materiale plastico



	L mm	L "	€	5	017190360
1719BM/RL	200	8	10,80	5	017190360

1719BMR

impugnatura per lime



	L mm	A mm	€	10	017190950
1719BMR/0	95	25	2,00	10	017190950
1719BMR/1	110	29	2,50	10	017190951
1719BMR/1B	110	29	2,00	10	017190953
1719BMR/2	123	31	2,70	10	017190952
1719 BMR/2B	123	31	2,70	10	017190954

	L mm	A "	€	10	017190950
1719BMR/0	100/150	4/6	▲▶●●	10	017190950
1719BMR/1	150/200	6/8	▲▶	10	017190951
1719BMR/1B	150/200	6/8	■▶	10	017190953
1719BMR/2	250/300	10/12	▲▶	10	017190952
1719 BMR/2B	250/300	10/12	■▶	10	017190954

1720/...

lime ad ago

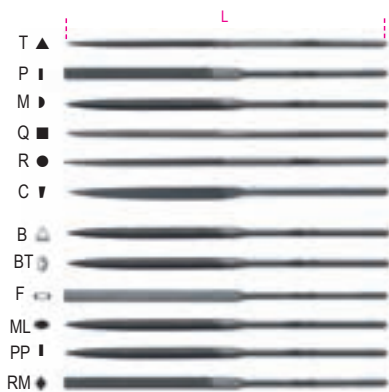

	L mm	€		
1720T	160	4,90	5	017200004
1720P	160	4,90	5	017200006
1720M	160	4,90	5	017200008
1720Q	160	4,90	5	017200009
1720R	160	4,90	5	017200010
1720C	160	4,90	5	017200012
1720B	160	4,90	5	017200005
1720ML	160	4,90	5	017200007
1720BT	160	4,90	5	017200011
1720F	160	4,90	5	017200013
1720PP	160	4,90	5	017200014
1720RM	160	4,90	5	017200015



1720/S3	€ 14,70	1	017200000
---------	---------	---	-----------

1720/B



1720/B6	€ 31,50	1	017200002
1720/B12	€ 59,00	1	017200003

1720D/...

lime ad ago diamantate



	L mm	€		
1720D/T	160	34,50	2	017200104
1720D/P	160	34,50	2	017200106
1720D/M	160	34,50	2	017200108
1720D/Q	160	34,50	2	017200109
1720D/R	160	34,50	2	017200110
1720D/C	160	34,50	2	017200112



1720D/B6	€ 209,00	1	017200120
----------	----------	---	-----------

1721/B6

serie di 6 lime per contatti
in busta di plastica



1721/B6	€ 17,40	1	017210010
---------	---------	---	-----------

1723

tenditore per molle



1723	L mm 210	€ 11,00	5	017230001
------	----------	---------	---	-----------

1725

seghetto



1725	L mm 420	L1 mm 300	€ 15,00	4	017250001
------	----------	-----------	---------	---	-----------

1725CR

miniseghetto

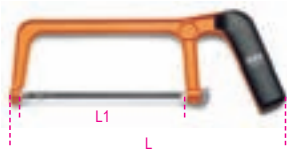

1725CR	L mm 250	L1 mm 150	€ 8,00	5	017250010
--------	----------	-----------	--------	---	-----------

1726

seghetto
sistema di tensionamento della lama
incorporato nell'impugnatura

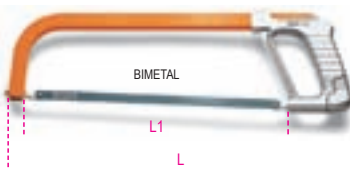

1726	L mm 440	L1 mm 300	€ 20,00	4	017260001
------	----------	-----------	---------	---	-----------

1726BM

seghetto con sistema di tensionamento
della lama a sgancio rapido

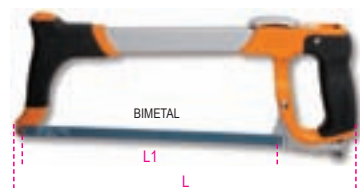

1726BM	L mm 400	L1 mm 300	€ 33,50	1	017260050
--------	----------	-----------	---------	---	-----------

1727

seghetto tipo pesante



1727	L mm 515	L1 mm 300	€ 14,00	4	017270001
------	----------	-----------	---------	---	-----------

1727BM

seghetto
portalama



1727BM	L mm 315	L1 mm 300	€ 17,00	5	017270020
--------	----------	-----------	---------	---	-----------

1728...

lame per segchetti

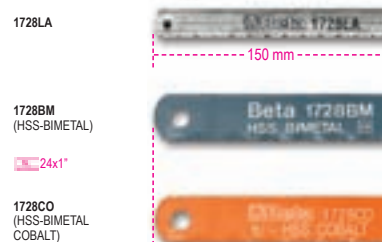

1728LA	€ 1,00	100	017280001
1725CR			
1725MQ			
1728BM	€ 2,50	100	017280010
1725-1726			
1727-1727M			
1728CO	€ 3,00	100	017280030
1725-1726			
1727-1727M			

1729

segoncino ad arco

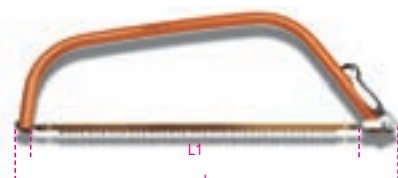

1729	L mm 710	L1 mm 610	€ 16,00	5	017290001
------	----------	-----------	---------	---	-----------

1729LR

lama per segoncino 1729



1729LR € 4,50 10 017290010

1729CG

seghetto per cartongesso



1729CG L mm 310 L1 mm 160 € 15,50 2 017290200

1729DM 450

segaccio per legno

dentatura media, 12 denti per pollice



1729DM L mm 450 L1 mm 400 € 17,50 4 017290450

1736A

spazzola per lime



1736A L mm 240 € 6,00 10 017360010

1737

spazzolino con fili di ottone



1737 L mm 145 € 3,50 10 017370001

1737NX

spazzola curva a fili di acciaio



1737NX L mm 270 € 4,50 5 017370010

1737AC

spazzola a fili di acciaio



1737AC L mm 275 € 4,00 5 017370020

1737B

coppie di spazzole per pulizia morsetti e poli batteria veicoli



1737B € 11,00 1 017370050

1738

pennello



1738 L mm 210 H mm 30 € 5,00 10 017380001

1739B

rivettatrice estensibile fornita con 5 testine intercambiabili



Ø mm	3,2	4	4,8	5	6	6,4
Alluminio	•	•	•	•	•	•
Acciaio	•	•	•	•	•	•
Inox	•	•	•	•	•	•

1739B € 90,00 1 017390151

1740A

rivettatrice di potenza fornita con 5 testine intercambiabili



Ø mm	3,2	4	4,8	5	6	6,4
Alluminio	•	•	•	•	•	•
Inox	•	•	•	•	•	•

1740A € 79,00 1 017400101

1740B

rivettatrice di potenza compatta fornita con 5 testine intercambiabili



Ø mm	2,4	3	3,2	4	4,8
Alluminio	•	•	•	•	•
Acciaio	•	•	•	•	•
Inox	•	•	•	•	•

1740 B280 L mm 280 € 50,00 1 017400280

Ø mm	3,2	4	4,8	5	6	6,4
Alluminio	•	•	•	•	•	•
Acciaio	•	•	•	•	•	•
Inox	•	•	•	•	•	•

1740 B330 L mm 330 € 60,00 1 017400330

1741B

rivettatrice fornita con 4 testine intercambiabili



Ø mm	2,4	3,2	4	4,8	5
Alluminio	•	•	•	•	•
Acciaio	•	•	•	•	•
Inox	•	•	•	•	•

1741B € 28,00 1 017410000

1741B/C5

rivettatrice 1741B con assortimento di 700 rivetti in alluminio



1741B/C5 € 82,00 1 017410025

	Ø mm	L mm	n.
1741RV2,9K	3,0	6	200
1741RV3,2K	3,2	8	200
1741RV3,8K	4,0	10	100
1741RV4K	4,0	12	100
1741RV4,8K	4,8	12	100

415x155x60 mm - 3,1 Kg



1741BP

rivettatrice
fornita con 4 testine intercambiabili



Ø mm	2,4	3,2	4	4,8	5
Alluminio	•	•	•	•	•
Acciaio	•	•	•	•	•
Inox	•	•	•	•	•

1741BP € 42,00 1 017410350

1741U

rivettatrice ultra compatta con regolazione dello sforzo
fornita con 4 testine intercambiabili
3 griffe: migliore presa del rivetto



Ø mm	2,4	3	3,2	4	4,8
Alluminio	•	•	•	•	•
Acciaio	•	•	•	•	•
Inox	•	•	•	•	•

1741U € 32,00 1 017410450

1741RV...K

rivetti in alluminio



1741RV2,9K	€ 11,50	1	017410191
ØxL = 3x6 mm			
1741RV3,2K	€ 12,00	1	017410192
ØxL = 3,2x8 mm			
1741RV3,8K	€ 15,50	1	017410193
ØxL = 4x10 mm			
1741RV4K	€ 17,50	1	017410194
ØxL = 4x12 mm			
1741RV4,8K	€ 21,50	1	017410195
ØxL = 4,8x12 mm			

I prezzi indicati sono relativi a 500 pezzi

Beta



1742

rivettatrice per inserti filettati
fornita con 4 testine intercambiabili
e 4 perni (1x M3;M4;M5;M6)



1742 € 92,00 1 017420001

M	Ø mm	L mm
3	5	11
4	6	11
5	7	13
6	9	17

1742KR

kit di 4 perni di ricambio per 1742



M3	€ 36,00	1	017420043
M4	€ 36,00	1	017420044
M5	€ 36,00	1	017420045
M6	€ 36,00	1	017420046

1742R-AL/M...

rivetti in alluminio filettati per 1742-1742A



1742R-AL/M3	€ 3,00	1	017420023
ØxL = 5x10 mm			
M = 3			
1742R-AL/M4	€ 3,20	1	017420024
ØxL = 6x12 mm			
M = 4			
1742R-AL/M5	€ 3,40	1	017420025
ØxL = 7x13 mm			
M = 5			
1742R-AL/M6	€ 4,10	1	017420026
ØxL = 9x15 mm			
M = 6			

I prezzi indicati sono relativi a 20 pezzi

1742R-A/M...

rivetti in acciaio filettati per 1742-1742A



1742R-A/M3	€ 3,20	1	017420013
ØxL = 5x11 mm			
M = 3			
1742R-A/M4	€ 3,30	1	017420014
ØxL = 6x11 mm			
M = 4			
1742R-A/M5	€ 3,50	1	017420015
ØxL = 7x13 mm			
M = 5			
1742R-A/M6	€ 4,20	1	017420016
ØxL = 9x17 mm			
M = 6			
1742R-A/M8	€ 4,40	1	017420018
ØxL = 11x17 mm			
M = 8			
1742R-A/M10	€ 4,80	1	017420020
ØxL = 13x24 mm			
M = 10			

I prezzi indicati sono relativi a 20 pezzi
• I prezzi indicati sono relativi a 10 pezzi

1742/C4

rivettatrice 1742 con assortimento di 400 inserti filettati in acciaio



1742/C4 € 195,00 1 017420005

	M	Ø mm	n.
1742R-A/M3	3	5	100
1742R-A/M4	4	6	100
1742R-A/M5	5	7	100
1742R-A/M6	6	9	100

415x155x60 mm - 2,9 kg

1742A

rivettatrice di potenza per inserti filettati
fornita con 4 testine intercambiabili



1742A € 350,00 1 017420100

M	Ø mm	L mm
5	7	13
6	9	17
8	11	17
10	13	24

Beta



1742A/KR

kit di 4 perni di ricambio per 1742A



1742A/KR	M5	€ 24,00	1	017420143
1742A/KR	M6	€ 24,00	1	017420144
1742A/KR	M8	€ 24,00	1	017420145
1742A/KR	M10	€ 24,00	1	017420146

1742A/C

rivettatrice 1742A con assortimento di 60 inserti filettati in acciaio



1742A/C	€ 375,00	1	017420105
---------	----------	---	-----------

	M	Ø mm	n.
1742R-A/M5	5	7	20
1742R-A/M6	6	9	20
1742R-A/M8	8	11	10
1742R-A/M10	10	13	10

536x310x80 mm - 2,1 kg

1743

pinza per fascette in Nylon

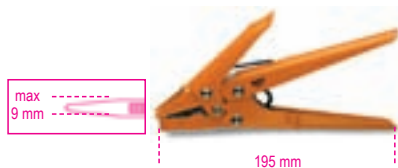

1743	€ 42,00	1	017430001
------	---------	---	-----------

1743T

pinza tagliafascette

• Adatta anche per il taglio di piccoli cavi (3x1.5mm²; 1x17mm²)



1743T	€ 23,00	1	017430100
-------	---------	---	-----------

1748/...K

fascette in Nylon a testa autobloccante nere

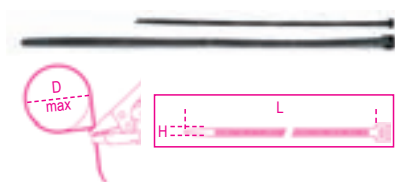

1748/3K	€ 4,00	1	017480203
HxL = 2,5x100 mm D = 18 mm			
1748/6K	€ 8,15	1	017480206
HxL = 2,5x160 mm D = 40 mm			
1748/7K	€ 9,60	1	017480207
HxL = 3,6x150 mm D = 33 mm			
1748/8K	€ 9,60	1	017480208
HxL = 3,6x200 mm D = 46 mm			
1748/9K	€ 11,50	1	017480209
HxL = 3,6x300 mm D = 70 mm			
1748/14K	€ 15,60	1	017480214
HxL = 4,8x190 mm D = 43 mm			
1748/17K	€ 16,80	1	017480217
HxL = 4,8x300 mm D = 72 mm			
1748/18K	€ 18,50	1	017480218
HxL = 4,8x360 mm D = 85 mm			
1748/23K	€ 33,50	1	017480223
HxL = 7,6x300 mm D = 67 mm			
1748/24K	€ 38,50	1	017480224
HxL = 7,6x368 mm D = 88 mm			

I prezzi indicati sono relativi a 100 pezzi

1748B/...K

fascette in Nylon, a testa autobloccante bianche

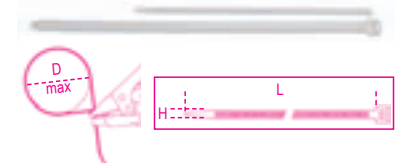

1748B/3K	€ 4,00	1	017480303
HxL = 2,5x100 mm D = 18 mm			
1748B/6K	€ 8,15	1	017480306
HxL = 2,5x160 mm D = 40 mm			
1748B/7K	€ 9,60	1	017480307
HxL = 3,6x150 mm D = 38 mm			
1748B/8K	€ 9,60	1	017480308
HxL = 3,6x200 mm D = 46 mm			
1748B/9K	€ 11,50	1	017480309
HxL = 3,6x300 mm D = 70 mm			
1748B/14K	€ 15,60	1	017480314
HxL = 4,8x190 mm D = 44 mm			
1748B/17K	€ 16,80	1	017480317
HxL = 4,8x300 mm D = 72 mm			
1748B/18K	€ 18,50	1	017480318
HxL = 4,8x360 mm D = 86 mm			

I prezzi indicati sono relativi a 100 pezzi

1748/C5

pinza per fascette con assortimento di 400 fascette



1748/C5	€ 97,00	1	017480100
---------	---------	---	-----------

	H mm	L mm	n.
1743			1
1748/3K	2,5	100	100
1748/7K	3,6	150	100
1748/8K	3,6	200	100
1748/14K	4,8	190	100

325x245x55 mm - 850 g

1749

pistola per sigillante



1749	L min mm 340	€ 10,00	2	017490001
------	--------------	---------	---	-----------

1749A

pistola per sigillante modello professionale tubo in alluminio. anche per sacchetti



1749A	L min mm 360	€ 31,00	1	017490010
-------	--------------	---------	---	-----------

1749AC

pistola ad alta spinta per ancoranti chimici



1749AC	L min mm 360	€ 26,00	1	017490005
--------	--------------	---------	---	-----------

1750

compressori a leva per grasso



cc	L mm	€		
500	380	29,00	1	017500500
750	450	35,00	1	017500750

1750R/1 - 1750R/2

tubi flessibili di ricambio
in Nylon



	L mm	€		
1750R/1	310	4,50	2	017500030
1750R/2	410	5,00	2	017500040

1750RC

tubo rigido piegato



	L mm	M mm	€		
1750RC	150	10x1	3,50	2	017500050

1750RT

testina a 4 griffe
tipo "Hydraulic"



	M mm	€		
1750RT	10x1	3,00	5	017500110

1750RP/1 - 1750RP/2

testine per raccordi piatti

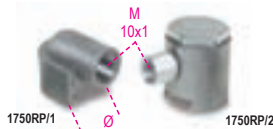

	Ø mm	M mm	€		
1750RP/1	16	10x1	8,50	2	017500115
1750RP/2	22	10x1	21,00	2	017500120

1750CG

cartucce di grasso per 1750



cc	€		
400	10,00	18	017500140
600	12,50	18	017500160

1750M

mini ingrassatore

- Con microugello
- Particolarmente indicato per utensili pneumatici



	cc	D mm	L mm	€		
1750M	100	43	145	16,00	1	017500025

1751

oliatori metallici a pressione
cannuccia flessibile



cc	D mm	L mm	€		
200	62	140	11,00	4	017510002
300	75	140	11,50	4	017510003
500	85	140	12,00	4	017510005
750	100	140	13,00	2	017510007
1000	100	140	14,50	2	017510011

1751R

cannuccia di ricambio
per 1751



	€		
200÷1000	3,00	5	017510010

1752

oliatori in plastica a pressione
cannuccia rigida



cc	D mm	L mm	€		
200	67	140	7,50	4	017520002
300	77	140	7,70	4	017520003
500	95	140	7,80	4	017520005
700	95	140	8,50	2	017520007

1752R

cannuccia di ricambio
per 1752



cc	€		
200÷700	3,00	5	017520020

1753

oliatori in plastica a pressione
cannuccia flessibile



cc	D mm	L mm	€		
200	65	190	7,00	4	017530002
300	80	190	7,20	4	017530003
500	95	190	7,50	4	017530005
700	95	190	8,00	2	017530007

1753R

cannuccia di ricambio
per 1753



cc	€		
200÷700	3,00	5	017530020

1754

oliatori in plastica a pressione
cannuccia flessibile



cc	D mm	L mm	€		
150	60	130	6,00	5	017540015
250	65	130	6,50	5	017540025

Beta

1755oliatori in plastica
cannuccia rientrante

cc	L mm	A mm	€		
30	160	30	4,50	5	017550003
80	170	47	5,00	5	017550008
150	230	58	5,50	5	017550015

1756

oliatore a stilo



cc	L mm	€		
5	140	16,00	2	017560001

1756B

siringa per olio



cc	L mm	€		
500	280	16,00	2	017560220

1757

rabboccatore per liquidi batterie



cc	D mm	€		
250	60	2,50	4	017570002
500	75	3,00	4	017570004
1000	90	4,00	2	017570006

1757A

colmatore per liquidi batterie



cc	L mm	€		
2000		29,00	1	017570020

1758

imbuto



1758	L mm	€		
	410	10,00	1	017580001

1759analizzatore ottico per liquidi di
raffreddamento, batteria, lavavetri e AdBlue®
in astuccio rigido

Compensazione automatica della temperatura
Acido batteria: intervallo di misura
da 1,1 a 1,3 kg/l
Liquido di raffreddamento propilene:
da -25°C a -50°C
Liquido di raffreddamento etilene: da -25°C a -50°C
Liquido lavavetri: da -10°C a -40°C
AdBlue(R): Misurazione percentuale di urea da 30% a 35%

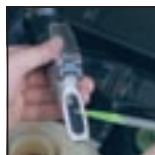

1759	€		
	105,00	1	017590251

1759A

densimetro per liquido anticongelante



1759A	L mm	€		
	340	48,00	1	017590001

1759B

densimetro per liquidi batteria



1759B	L mm	€		
	280	30,00	1	017590005

1759HD/3strumenti per controllo tenuta
impianto di raffreddamento e
riempimento circuito

• Permette di verificare sotto pressione le perdite del circuito (tubi, giunti, pompe, radiatori) e riempire velocemente il circuito evitando la formazione di bolle d'aria



1759HD/3	€		
	420,00	1	017590063

600x500x140 mm

1759HD/RRstrumento per riempimento
impianto di raffreddamento

1759HD/RR	€		
	122,00	1	017590064

450x310x110 mm

1760DGT

multimetro digitale automotive



CE

195 mm

92 mm



DATI TECNICI

RPM (tachimetro):

Per motori a 2 e 4 cilindri

RPM4 600 - 4000 RPM

RPM4 600 - 12000 RPM (x10 RPM)

RPM2/DIS 300 - 4000 RPM

RPM2/DIS 300 - 6000 RPM (x10 RPM)

Angolo Dwell: 4-8 CYL

Tensione DC: 400mV-4/40/400/1000V

Tensione AC: 4/40/400/700V

Corrente DC: 40/400mA-4/20A

Corrente AC: 40/400mA-4/20A

Resistenza: 400Ω-4/40/400kΩ-4/40MΩ

Capacità: 40/400nF-4/40/100μF

Frequenza: 5/50/500Hz-50/500-10MHz

Duty Cycle: 0.1 - 99.9%

Ampiezza pulsazioni: 1 - 10ms

Prova diodi: Corrente test 0,3mA

Continuità: <150Ω - Corrente test <0,3mA

Display: LCD ad alto contrasto 4 digit retro-illuminato

Sovratensione: Categoria II 1000V

Autospegnimento: 30 minuti

Alimentazione: 1 batteria 9V (inclusa)

Pinza induttiva (inclusa)

2 Puntali (inclusi)

Custodia morbida in tela (inclusa)

Manuale d'uso

1760DGT

€ 190,00



1 017600005

1760 400A

pinza amperometrica per multimetri

AC/DC



CE

PARAMETRI RILEVABILI

Corrente max: 400A

Frequenza: 50/60 Hz

Alimentazione: 1 batteria da 9V (inclusa)

1760 400A

€ 149,00



1 017600080

1760B

multimetro digitale



CE



PARAMETRI RILEVABILI

Tensione DC: 200 mV-2/20/200/1000V

Tensione AC: 2-20/200/700V

Corrente DC: 2/20/200 mA-20 A

Corrente AC: 2/200 mA- 20 A

Resistenza: 200Ω - 2/20/200 kΩ - 2/20 MΩ

Capacità: 2/20/200 nF - 2/200 μF

Temperatura: -20° + 1000°C/ -4 °F ~ +2000°F

Frequenza: 20kHz

Alimentazione: 1 batteria da 9V (inclusa)

1760B

€ 115,00



1 017600012

1760/RMS

multimetro industriale IP67

con lettura a valore efficace RMS



CE

Campo di misura Precisione base

Tensione AC/DC 110mV - 600V ±0.8% - ±2% rdg

Corrente AC/DC 110μA - 10A ±1.5% - ±2% rdg

Resistenza 110Ω - 40MΩ ±1.2% - ±2.5% rdg

Capacità 11nF - 40mF ±5% - ±10% rdg (fino a 11mF)

Frequenza 1100Hz - 110 MHz ±1.2% - ±1.5% rdg

Temperatura -32°C - +1000°C ±3% - ±5% rdg

Test diodi 3V dc ±10% rdg

Test continuità <30 Ω

1760/RMS

€ 202,00



1 017600020

1760K/MT

multimetro automotive digitale con termometro ad infrarossi e pinza ad induzione in valigetta di plastica



Tensione DC: 400mV-4/40/400/600V

Tensione AC: 400mV-4/40/400/600V

Corrente DC: 40/400mA-20A

Corrente AC: 40/400mA-20A

Resistenza: 400Ω-4/40/400kΩ-4/40MΩ

Capacità: 4/40/400nF-4/40/400μF-4/40mF

Frequenza: 4/40/400Hz-4/40MHz

Test continuità: <35Ω

Funzione angolo Dwell: 4-8 Cil

Funzione duty cycle: 0,5% + 99,0%

Ampiezza pulsazioni: 1.0 + 20.0 ms

Prova diodi: corrente test 1.0mA

Funzione memorizzazione picco max

Funzione memorizzazione dato

Funzione autorange

Alimentazione multimetro: 1 batteria da 9

volt (inclusa)

Temperatura con termometro laser: -30°C a +550°C (emissività

fissa 0,95)

Temperatura con termocoppia tipo K:

-30°C a +1000°C

Alimentazione termometro: 1 batteria da 9

volt (inclusa)

Pinza ad induzione: 4 tempi da 600 a 4000 RPM

da 1000 a 12000 RPM (x10RPM)

2 tempi da 300 a 4000 RPM

da 1000 6000 RPM (x 10RPM)

1760K/MT

€ 340,00



1 017600200

Beta

1760PA/AC

pinza amperometrica e multimetro digitale

A: AC

V: AC/DC



CE



PARAMETRI RILEVABILI

Tensione DC: 400 mV - 4/40/400/600 V
 Tensione AC: 400 mV - 4/40/400/600 V
 Corrente AC: 40/400/1000 A
 Resistenza: 400Ω - 4/40/400 kΩ - 4/40 MΩ
 Frequenza: 5/50/500 Hz - 5/50/500 kHz - 5/10 MHz
 Capacità: 40/400 nF - 4/40/100 μF
 Temperatura: -20°C ÷ 1000°C / -4 °F ÷ 1832 °F
 Alimentazione: 1 batteria da 9V (inclusa)

1760PA/AC 190 € 129,00 1 017600050

1760PA/AC-DC

pinza amperometrica e multimetro digitale

A: AC/DC

V: AC/DC



CE



PARAMETRI RILEVABILI

Tensione DC: 0.1mV ÷ 600V
 Tensione AC: 0.1mV ÷ 600V
 Corrente AC: 0.01A ÷ 1000A
 Corrente DC: 0.01A ÷ 1000A
 Resistenza: 0.1Ω ÷ 40MΩ
 Capacità: 0.001nF ÷ 40 μF
 Frequenza: 0.001kHz ÷ 4kHz
 Temperatura: -40°C ÷ 1000 °C
 -40°F ÷ 1832°F

1760PA/AC-DC 210,00 € 1 017600000

1760/TC2

tachimetro digitale a distanza e a contatto



CE

DATI TECNICI

- Per misurazione di:
 - rotazione a distanza (g/min - rpm)
 - rotazione (g/min - rpm) e velocità lineare (m/min o ft/min) a contatto.
- Display LCD a 5 cifre.
- Scala:
 - a distanza 2,5÷99.999 g/min
 - a contatto 0,5÷19.999 g/min
 - velocità lineare 0,05÷1.999,9 m/min.
- Frequenza: 0,8 sec.
- Alimentazione: 4 batterie 1,5V (AA) (incluse) o alimentatore 6V (non incluso)
- Fornito con:
 - adattatore per misurazioni a contatto
 - 2 puntali maschio in gomma
 - 1 puntale femmina in gomma
 - 1 rotella per rilevazioni lineari
 - etichette riflettenti
 - manuale di istruzioni
 - custodia in plastica.

1760/TC2 230 74 € 185,00 1 017600161

1760R/TC2

etichette riflettenti per 1760/TC2



1760R/TC2 € 16,50 1 017600561

1760/IR800

termometro digitale ad infrarossi con doppio puntamento laser



CE

DATI TECNICI

Gamma: da -50°C a 800°C / da -58°F a 1472°F
 Selezione scala: °C/°F
 Precisione: ±1,0% o ±1,0°C a 20°C
 Potenza Laser: <1mW
 Risposta: 150ms
 Emissività: 0,10-1,0 regolabile
 Rapporto distanza: (D:S) 20:1
 Temperatura operativa: 0°C ÷ 50°C / 32°F ÷ 122°F
 Umidità operativa: da 10% a 90% RH
 Display LCD retro-illuminato
 Funzione di mantenimento dei dati
 Auto spegnimento
 Alimentazione: 1 batteria 9V (inclusa)
 Custodia morbida in tela (inclusa)
 Manuale d'uso

1760/IR800 € 235,00 1 017600380

1760/IR1600

termometro digitale ad infrarossi con puntamento laser



CE

DATI TECNICI

Gamma: da -50°C a 1600°C / da -58°F a 2912°F
 Selezione scala: °C/°F
 Precisione: ±1,5% o ±2°C a 20°C
 Potenza Laser: <1mW
 Risposta: 1sec
 Emissività: 0,10-1,0 regolabile
 Rapporto distanza: (D:S) 50:1
 Temperatura operativa: 0°C ÷ 50°C / 32°F ÷ 122°F
 Umidità operativa: da 10% a 90% RH
 Display LCD retro-illuminato
 Funzione di mantenimento dei dati
 Auto spegnimento
 Alimentazione: 1 batteria 9V (inclusa)
 Custodia rigida e treppiede in alluminio
 Manuale d'uso

1760/IR1600 € 595,00 1 017600460

Beta

1760/2TM

termometro digitale a due uscite



CE

- Termometro a termocoppia di tipo K a due ingressi
- Display LCD 42 mm con indicatore di funzione, retro-illuminato.
- Lettura massima di 1999
- Misurazioni in gradi Celsius (°C) o Fahrenheit (°F) selezionabili
- Gamma: da -50 °C a 1300 °C / da -58 °F a 2372 °F
- Risoluzione: 1 °C o 1 °F - 0,1 °C o 0,1 °F
- Precisione dello 0,5% del massimo valore e di ritenuta dati
- Dotazione: 2 sensori a termocoppia di tipo K
- Custodia morbida in tela
- 1 batteria 9V inclusa
- Manuale d'uso

1760/2TM € 165,00 1 017600100

1761

pinza torcifilo a ritorno automatico

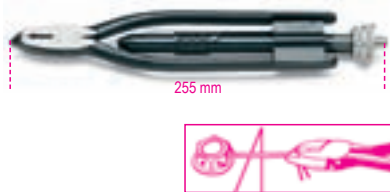

1761 € 89,00 1 017610001

1761RS/1

pinza torcifilo reversibile a ritorno automatico



1761RS/1 L mm 220 € 195,00 1 017610030

1762

pinza fustellatrice



1762 Ø mm L mm 2-2,5-3 210 € 21,00 2 017620001
3,5-4-4,5

1765/C24

cassetta di 24 attrezzi per estrazione autoradio



1765/C24 € 142,00 1 017650001

1766

ventosa doppia

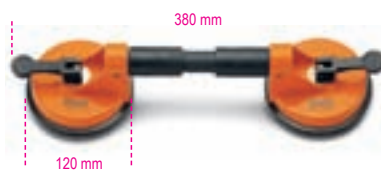

1766 max kg 50 € 113,00 2 017660001

1766A

ventosa singola



1766A max kg 30 € 25,00 2 017660005

1766/8

assortimento di 8 utensili per cristalli auto



1766/8 € 365,00 1 017660100

1766L

leva per cristalli



1766L € 34,00 1 017660015

1766I

impugnatura per cavo d'acciaio 1766G



1766I € 31,00 2 017660020

1766G

cavo d'acciaio per cristalli



1766G 50 m € 30,00 1 017660025

1767PMC

portaminuterie magnetico tondo



1767PMC € 15,00 1 017670020

1767PMR

portaminuterie magnetico rettangolare



1767PMR € 30,00 1 017670010

1770

cutter extra piatto
fornito con 2 lame



1770	L mm	A mm	€		
	140	9	12,00	10	017700001

1770A

cutter con blocco automatico della lama,
fornito con 3 lame



1770A	L mm	A mm	€		
	135	9	4,50	10	017700025

1770RL

10 lame a settori 9 mm
per cutter 1770 e 1770A



1770RL	€		
	4,00	5	017700010

1770BM

cutter 9 mm,
fornito con 6 lame



1770BM	L mm	A mm	€		
	140	9	8,50	10	017700050

1771

cutter 18 mm
fornito con 3 lame



1771	€		
	6,90	10	017710000

1771BM

cutter 18 mm
fornito con 6 lame



1771BM	L mm	A mm	€		
	170	18	15,30	10	017710050

1771RL

10 lame a settori 18 mm
per cutter 1771 e 1771BM



1771RL	€		
	5,70	5	017710010

1772B

cutter a lama retrattile,
fornito con 2 lame



1772B	L mm	A mm	€		
	165	18	9,80	10	017720005

1772H

cutter a lama retrattile di sicurezza,
fornito con 2 lame



1772H	L mm	A mm	€		
	170	18	12,50	5	017720029

1772RL/2

10 lame trapezoidali lunghe, in astuccio,
per cutter 1772B, 1772BMT
1772H, 1774, 1777T

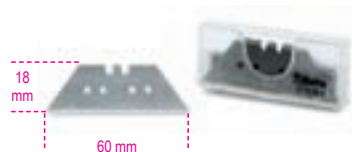

1772RL/2	€		
	3,20	5	017720017

1773A

cutter 25 mm

- sistema bloccalama a ghiera
- lama da 25 mm



1773A	L mm	A mm	€		
	180	25	13,50	10	017730000

1773RL

10 lame a settori 25 mm
per cutter 1773A



1773RL	€		
	18,50	5	017730015

1774

raschietto multiuso
con salvalama di protezione



1774	L mm	L1 mm	€		
	165	60	2,80	5	017740001

1774A

raschietto multiuso
con impugnatura bimatériale



1774A	L mm	L1 mm	€		
	300	40	9,00	1	017740011

1774A/RL

10 lame per raschietto 1774A

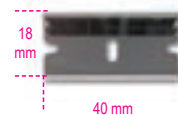

1774A/RL	€		
	4,00	1	017740511

1777BM

coltello a serramanico con gola spellafili
lama in acciaio inossidabile



1777BM	L mm	L1 mm	A mm	€		
	190	80	16	8,50	5	017770100

1777T

cutter a serramanico con lama trapezoidale
impugnatura in alluminio, fornito con 5 lame



1777T	L mm	A mm	L1 mm	€		
	160	19	65	18,50	5	017770030

1777BMT

cutter a serramanico con lama trapezoidale
4 profondità regolabili della lama
4; 9,5; 15,5; 21,5 mm
fornito con 3 lame



	L mm	L1 mm	A mm	€	5	017770050
1777BMT	170	80	25	18,00		

1778

coltello a serramanico
impugnatura in alluminio



	L mm	A mm	L1 mm	€	5	017780045
1778	195	24	80	22,00		

1778D

coltello a serramanico
lama ed impugnatura in acciaio inossidabile



	L mm	A mm	L1 mm	€	5	017780060
1778D	180	22	78	26,00		

1778SAFE

coltello a serramanico
lama in acciaio temprato
con funzione martello frangicristallo,
tagliacinture di sicurezza e punzone
scioglinodi



	L mm	A mm	L1 mm	€	5	017780090
1778SAFE	210	25	85	34,00		

1778SOS

coltello soccorso auto
con funzione martello frangicristallo
e tagliacinture di sicurezza



	L mm	A mm	L1 mm	€	5	017780080
1778SOS	205	25	85	24,00		

1778W

coltello a serramanico
lama in acciaio inossidabile
impugnatura con inserti in legno



	L mm	A mm	L1 mm	€	5	017780025
1778W	180	22	78	26,00		

1778X

coltelli per nautica in acciaio inossidabile
impugnatura in alluminio



	L mm	L1 mm	A mm	€	2	017780050
1778X	185	85	25	20,00		

1779

pinzetta autobloccante
becchi arrotondati, zigrinati
in acciaio inossidabile



	L mm	€	5	017790001
1779	160	22,50		

1781

forbici a lame lunghe sottili



	L mm	€	2	017810001
1781	132	12,50		

1783

forbici modello leggero



	L mm	€	5	017830021
1783	215	14,00		
	240	15,50		5 017830024

1784

forbici modello pesante



L mm	€	2	017840017
175	18,50		
200	20,50		2 017840020
250	27,50		2 017840025
300	36,00		2 017840030

1800/100

cuscini sollevatori (max 100 kg)

- sollevare-livellare
- bloccare porte ed ante



A mm	B mm	S mm	€	3	018000000
160	150	2÷55	42,00		

1808

saldatore a doppia potenza
con punta acciata 1824 R08



W	V	€	1	018080001
20/130	230	52,00		

1812

saldatore istantaneo (4 s.)



W	V	€	1	018120001
100	230	112,00		

1812E

saldatore istantaneo (20 s.)



W	V	€	1	018120100
150	230	125,00		

1814M

saldatori a stilo
con punta acciaiata

CE



W	V	€	Icona	Icona
25	230	45,00	1	018140225
30	230	49,00	1	018140230
40	230	53,00	1	018140240

1820/30 - 50 - 80

saldatori a stilo
con punta in rame 1824R20

CE



Modello	Watt	Lunghezza	€	Icona	Icona
1820/30	30W	L = 255 mm	48,00	1	018200030
1820/50	50W	L = 265 mm	52,00	1	018200050
1820/80	80W	L = 280 mm	56,00	1	018200080

1822A/...

saldatori a martello
con punta 1824R22A

CE



Modello	Watt	Lunghezza	€	Icona	Icona
1822A/1	100W	LxA = 250x130 mm	100,00	1	018220410
1822A/2	180W	LxA = 260x145 mm	116,00	1	018220420
1822A/3	280W	LxA = 270x165 mm	156,00	1	018220430

1823

stazione di saldatura
a controllo digitale
fornita con saldatore

- Regolazione continua della temperatura da 150°C a 400°C con precisione ±1%.
- Funzione di memoria per salvataggio temperatura selezionata al momento dello spegnimento.
- Funzione di blocco temperatura scelta con disattivazione della tastiera mediante password.
- Funzione di selezione di una delle quattro temperature pre-memorizzate (250°C-300°C-350°C-400°C).



Modello	W	V	€	Icona	Icona
1823	60	230	710,00	1	018230000

1823RS

saldatore di ricambio
per 1823



1823RS	€ 170,00	1	018230030
--------	----------	---	-----------

1824R

punte di ricambio
per saldatori



Modello	€	Icona	Icona
1824R08 1808	21,00	1	018240100
1824R12/A 1812	12,00	1	018240003
1824R12/B 1812	12,00	1	018240005
1824R12/C 1812	12,00	1	018240007
1824R12 1812E	21,00	1	018240120
1824R14-M25 1814M/25	3,00	1	018240152
1824R14-M30 1814M/30	3,00	1	018240153
1824 1814M/40	3,00	1	018240154
1824R20/3 1820/30	7,00	1	018240019
1824R20/5 1820/50	12,00	1	018240021
1824R20/8 1820/80	9,00	1	018240023
1824R22A/1 1822A/1	17,00	1	018240041
1824R22A/2 1822A/2	21,00	1	018240042
1824R22A/3 1822A/3	44,00	1	018240043
1824R-ST 1823R-ST	48,00	1	018240233

1825ST250

filo per saldatura in stagno con antiossidante

- filo da 1 mm²
- Sn 99% Ag 0.3% Cu 0.7%



Ø mm	g	€	Icona	Icona
1	250	44,00	1	018250250

1827

saldatore a gas regolabile



1827	€ 96,00	1	018270001
------	---------	---	-----------

1827PC

punte di ricambio coniche per 1827

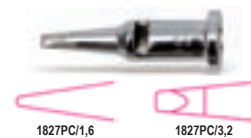

Modello	€	Icona	Icona
1827PC/1,6	19,50	1	018270501
1827PC/3,2	19,50	1	018270502

1827PCL

punte di ricambio a coltello per 1827



1827PCL/2,4	€ 19,50	1	018270503
-------------	---------	---	-----------

1827PFL

punte di ricambio a fiamma libera
per 1827



1827PFL	€ 19,50	1	018270504
---------	---------	---	-----------

1827/K

saldatore a gas con 7 accessori
in valigetta con base morbida
di polietilene espanso



- Potenza: da 30 Watt a 125 Watt.
- Temperatura della punta regolabile da 250°C a 500°C.
- Regolatore del flusso di gas.
- Tempo di riscaldamento: 15 secondi dopo l'accensione.
- Il serbatoio contiene gas per 120 minuti di utilizzo continuato.
- Serbatoio trasparente per monitorare il livello di gas.
- Ricaricabile con gas butano.

1827/K	€ 147,00	1	018270100
--------	----------	---	-----------

1830T

pompette per dissaldare con ugello antistatico
in materiale plastico (PTFE)



L mm	€	Icona	Icona
190	10,00	5	018300021

Beta

1834S

torcia LED ad alta luminosità in robusto alluminio anodizzato, fino a **90 Lumen**

• Pile 2xAAA (non include)



L mm 150 € 26,00 1 018340010

1834M

torcia LED ad alta luminosità in robusto alluminio anodizzato, fino a **190 Lumen**

• Pile 3xAAA (non include)



L mm 140 € 33,00 1 018340020

1834L

torcia LED ad alta luminosità in robusto alluminio anodizzato, fino a **450 Lumen**

• pile 3xAA (non include)



L mm 210 € 50,00 1 018340025

1834XL

torcia LED ad alta luminosità in robusto alluminio anodizzato, fino a **650 Lumen**

• Pile 3xD (non include)



L mm 315 € 61,00 1 018340030

1835/1

torcia LED per ispezioni, in robusto alluminio anodizzato

Pile 1xAAA (non include)



L mm 105 € 13,50 3 018350030

1835/2

torcia LED per ispezioni, in robusto alluminio anodizzato

Pile 2xAAA (non include)



L mm 145 € 15,00 3 018350060

1836

lampada da testa a LED snodata, con doppia luminosità e sensore ON/OFF

• Fuoco regolabile
• 90 Lumen
• Pile: 3xAAA include

CE



1836 € 35,00 1 018360100

1837

lampada magnetica snodata con LED ad alta luminosità

• Pile 3xAA (non include)



L mm 450 € 54,00 1 018370001

1837E

faretto a LED da cantiere, 30W

LED resistente agli urti; 50.000 ore di vita corpo in alluminio IP66



A mm 380 B mm 280 W mm 30 € 185,00 1 018370501

1838/10LED

lampada a LED portatile ricaricabile

• batteria ai polimeri di Lito
• vetrino frontale facilmente sostituibile
• gancio orientabile
• con stazione di ricarica
• 320 Lumen

CE



• Resistente a olii e grasso
• Appendibile, con corpo in gomma antiscivolo e antiurto
• Batteria ai polimeri di Lito: leggera e di lunga autonomia
• 10 LED ad altissima luminosità

1838/10LED € 106,00 1 018380000

1838RV/10LED

frontalino parafraggi di ricambio per lampada 1838/10LED



1838RV/10LED € 1,50 2 018380900



1838LED/120

lampada sottocofano orientabile a LED

- Cavo antioilo da 5m
- Striscia LED da 600 Lumen, 7.5W
- Apertura ganci: 120 ± 170 cm



1838LED/120 € 180,00 1 018380250

1838SL

lampada ultrasottile con LED ad altissima luminosità.

Per lavori in spazi ristretti

- alimentazione 12V con spina accendisigari e morsetti per batteria
- cavo da 2,5 m
- spessore 6mm
- 345 Lumen



1838SL € 47,00 1 018380101

1840BM

portalampana portatile per lampada con attacco E27 alimentazione 230V

- Lampadina esclusa



1840BM € 45,00 1 018400101

1840WBM

portalampana portatile per lampada con attacco E27 alimentazione 230V

- Lampadina esclusa



1840WBM € 91,00 1 018400120

1841BM

portalampana portatile completo di lampada fluorescente. alimentazione 230V



1841BM € 83,00 1 018410101

1841ABM

portalampana portatile completo di lampada fluorescente. alimentazione 24V



1841ABM € 83,00 1 018410110

1842XBM

lampada portatile a LED. alimentazione 110÷230V, 350 Lumen



1842XBM € 99,00 1 018420201

1842XABM

lampada portatile a LED. alimentazione 24V, 350 Lumen



1842XABM € 99,00 1 018420211

1843BM

avvolgitore automatico completo di portalampana 230 Vac con attacco E27 e gabbia in acciaio

- Lampadina esclusa
- Max 60W



1843BM € 245,00 1 018430101

1843R/BM

portalampana di ricambio per avvolgitore, con attacco lampada E27

- Lampadina esclusa



1843 R/BM € 35,00 1 018430131

1843WBM

avvolgitore automatico completo di portalampana 230 Vac con attacco E27

- Lampadina esclusa
- Max 60W



1843WBM € 320,00 1 018430120

1843R/WBM

portalampana di ricambio per avvolgitore, con attacco lampada E27

- Lampadina esclusa



1843 R/WBM € 76,00 1 018430132

1844BM

avvolgitore automatico completo di portalampana a fluorescenza alimentazione 230 Vac

- Con trasformatore di sicurezza 230/24V
- Lampada 11W inclusa
- Max 25W

CE

IP42
IP55

L=15 m

1844BM € 335,00 1 018440104

1844ABM

avvolgitore automatico completo di portalampana a fluorescenza alimentazione 24 Vac

- Lampada 11W inclusa
- Max 60W

CE

IP42
IP55

L=15 m

1844ABM € 255,00 1 018440102

1844R/BM

portalampana di ricambio per avvolgitore, con lampada fluorescente

CE



IP55

1844 R/BM € 68,00 1 018440131

1846XBM

avvolgitore automatico completo di lampada a LED alimentazione 230 Vac

- Con trasformatore di sicurezza 230/24V
- Max 25W

CE

IP42
IP55

L=15 m

1846XBM € 360,00 1 018460201

1846XABM

avvolgitore automatico completo di lampada a LED alimentazione 24 Vac

- Max 60W

CE

IP42
IP55

L=15 m

1846XABM € 280,00 1 018460211

1846R/XBM

lampada di ricambio per avvolgitore, a LED

CE



IP55

1846R/XBM € 90,00 1 018460231

1847P

tester combinato di tensione e di continuità 6÷690V AC/DC



CE

L=1 m

6÷690V AC/DC

DATI TECNICI

Campo di tensione: 6÷690V AC/DC
Gamma di frequenza: 0÷100Hz
Resistenza a tensioni di punta: 8 kV
Resistenza d'entrata: ≥300kΩ
Corrente d'entrata: Is < 2,5 mA a 690V
Prova di continuità: <500 kΩ
2 pile AAA

1847P € 95,00 1 018470010

1847K

rilevatore di tensione AC senza contatto con mini-torcia LED



CE

Campo di rilevamento: 200÷1000V AC
50/60 Hz

1847K L mm 180 € 28,00 1 018470101

1848

avvolgitore automatico con presa Schuko

- Max 1600 W a cavo svolto
- Max 1200 W a cavo avvolto

CE



L=15 m

1848 € 290,00 1 018480015

1850B

pistola termica 2 velocità

- Pos. I 240 l/min 300°C
- Pos. II 450 l/min 500°C

- possibilità di utilizzo con la pistola appoggiata verticalmente su un piano

CE

1600W
300÷500 C°230V
Schuko

L=2,4 m

1850B L mm 240 H mm 190 € 99,00 1 018500011

Beta

ISO 9001

1850C

pistola termica
con regolazione elettronica

- Pos. I 150-250 l/min 50°C
- Pos. II 150-500 l/min 50-650°C

- Display digitale.
- Pulsanti regolazione temperatura e portata del flusso.
- Possibilità di utilizzo con la pistola appoggiata verticalmente su un piano.
- 4 programmi memorizzati in origine e possibilità di personalizzazioni

- Prog 1 250°C ca. 350 l/min
- Prog 2 350°C ca. 400 l/min
- Prog 3 450°C ca. 500 l/min
- Prog 4 550°C ca. 400 l/min



CE



	L mm	H mm	€	1	018500015
1850C	255	210	260,00		

1850U...

ugelli per 1850B e 1850C

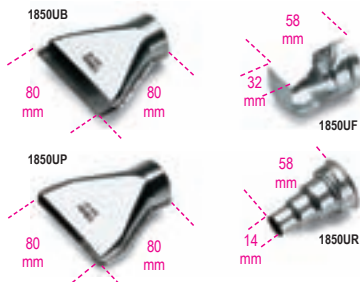

	1850	€	1	018500100
1850UB	B-C	17,50		
1850UF	B-C	19,50		
1850UP	B-C	17,50		
1850UR	C	16,50		

1851VK

pistola per colla a caldo con 12 stick di colla termofusibile in valigetta

Ø 11 e 12 mm

CE



	€	1	018510058
1851VK	37,00		

320x250x50 mm

1851VK-12C

12 stick di colla termofusibile

Ø 11 mm



	€	1	018510062
1851VK-12C	8,00		

1860K/140A

saldatrici con tecnologia inverter, adatte per motogeneratori, compatte e facili da trasportare, fornite di cavi, martospazzola e tracolla.



Corrente di regolazione: 5÷130A
Alimentazione: 1x230V
Potenza assorbita: MAX 3,0 KVA
Fattore di utilizzo: 35% - 130 A
60% - 80 A
100% - 70 A
Fusibile ritardato: 20 A
Protezione: IP23
Temperatura di esercizio: -15/+40° C (+5/+104° F)
Elettrodi utilizzabili: Ø 1.5 - 3.25mm

	€	1	018600014
1860K/140A	610,00		

1860K/160A

saldatrici con tecnologia inverter, adatte per motogeneratori, compatte e facili da trasportare, fornite di cavi, martospazzola e tracolla.



Corrente di regolazione: 5÷155A
Alimentazione: 1x230V
Potenza assorbita: MAX 3,7 KVA
Fattore di utilizzo: 35% - 150 A
60% - 130 A
100% - 100 A
Fusibile ritardato: 20 A
Protezione: IP21
Temperatura di esercizio: -15/+40° C (+5/+104° F)
Elettrodi utilizzabili: Ø 1.5 - 4mm

	€	1	018600016
1860K/160A	780,00		

1860R/C

cavi e pinze per inverter 1860K

	€	1	018600501
1860R/C	93,00		

1879

aspiratore liquidi manuale e pneumatico da 9,5 Litri



	€	1	018790001
1879	210,00		

1880

pompa manuale per fusti olio

- Per olio
- Non usare con liquidi a base acquosa, solventi acidi, gasolio, benzina e simili
- Completa di attacco fusto, tubo telescopico e beccuccio di mandata



	gr	€	1	018800001
1880	240	41,00		

1881

pompa pneumatica per fusti olio rapporto 3:1

- Pressione di lavoro da 6 a 8 bar
- Consumo aria 230 l/min
- Per olio
- Non usare con liquidi a base acquosa, solventi acidi, gasolio, benzina e simili
- Completa di attacco fusto e tubo telescopico



	l/min	€	1	018810001
1881	14	355,00		

1882

pistola olio con estremità flessibile e salvagoccia automatico

- Attacco 1/2"
- Portata massima 65 l/min
- Pressione massima di esercizio 100 bar
- Possibilità di bloccare la leva di erogazione



	€	1	018820010
1882	105,00		

1883

contaltri digitale per olio

- Attacco 1/2"
- Rivestimento in gomma anti urto
- Pila 1 CR2 (inclusa)
- Portata Max: 0+35 l/min (0+9 gal/min)
- Pressione Max: 50 bar (750 psi)
- Viscosità: 8+5000 mPas
- Tolleranza: ±0,5%

CE



1883

€ 155,00 1 018830035

1883NC

niplex maschio-maschio 1/2 per unire art. 1882 e 1883



1883NC

€ 9,50 1 018830135

2252

seggolino con rotelle

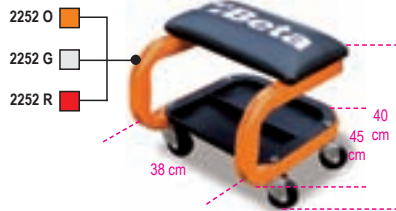

2252 O	€ 128,00	1	022520001
2252 G	€ 128,00	1	022520002
2252 R	€ 128,00	1	022520003

2252KR4

4 ruote di ricambio seggolino



2252KR4 € 45,00 1 022520900

3000M/LT

lettino sottomacchina

- Rivestimento in PVC con imbottitura in gomma piuma per un elevato comfort.

REGOLAZIONE DEL CUSCINO TRAMITE PISTONE A MOLLA PROGRESSIVA



3000M/LT € 120,00 1 030000220

7,3 kg

3000M/RLS

ruota di ricambio lettino sottomacchina



3000M/RLS € 7,00 1 030000206

3002

lettino sottomacchina e seggolino

- Struttura in acciaio
- Rivestimento in PVC con imbottitura
- Possibilità di regolare la posizione rapidamente: lettino o seggolino

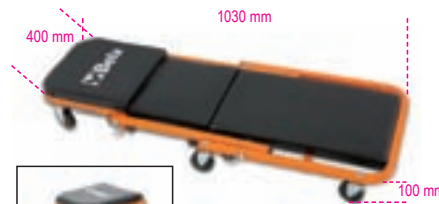

3002 € 75,00 1 030020001

3003

lettino sottomacchina in plastica antiurto

- Ø ruote: 76 mm

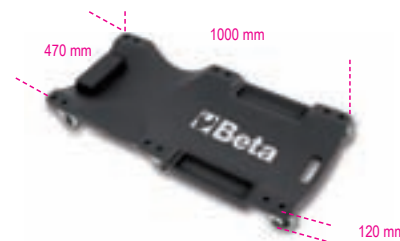

3003 € 55,00 1 030030001

3009

carrello per movimentazione veicoli

- Portata Max 550 kg
- 4 rulli basculanti
- Larghezza rulli 200 mm
- Per ruote fino a 240 mm di larghezza



A B € 320,00 1 030090001

3010/T...

coppia cavalletti

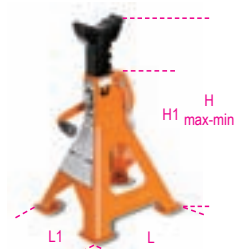

C max kg	H min mm	H max mm	H1 mm	L mm	L1 mm
2000	280	425	245	185	165

3010/T2 € 69,00 1 030100002

C max kg	H min mm	H max mm	H1 mm	L mm	L1 mm
3000	285	430	250	180	195

3010/T3 € 88,00 1 030100003

C max kg	H min mm	H max mm	H1 mm	L mm	L1 mm
6000	400	580	340	245	280

3010/T6 € 128,00 1 030100006

C max kg	H min mm	H max mm	H1 mm	L mm	L1 mm
10000	471	735	420	330	290

3010/T10 € 204,00 1 030100010



3011/T

solleventori idraulici a bottiglia

CE



C max	H min	H max	L
kg	mm	mm	mm
3500	170	366	86

3011/T3,5 € 68,00 1 030110035

C max	H min	H max	L
kg	mm	mm	mm
5000	203	467	118

3011/T5 € 78,00 1 030110050

C max	H min	H max	L
kg	mm	mm	mm
10000	220	484	114

3011/T10 € 115,00 1 030110100

C max	H min	H max	L
kg	mm	mm	mm
15000	230	497	113

3011/T15 € 165,00 1 030110150

C max	H min	H max	L
kg	mm	mm	mm
20.000	406	521	115

3011/T20 € 230,00 1 030110200

3012

staffa sostegno motore



L	C max	€	1	030120010
mm	kg			
1500	500	215,00	1	030120010
1800	400	295,00	1	030120018

3012I

staffa sostegno motore inferiore

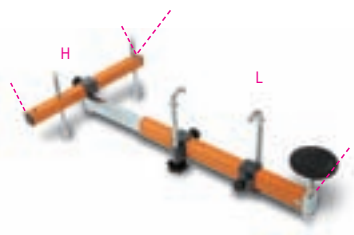

L	H	€	1	030120250
mm	mm			
630=960	190	545,00	1	030120250

3014

cavalletto sostegno motore



3014 € 270,00 1 030140010

3014 SAR

cavalletto sostegno motore richiudibile

- Facilmente richiudibile con notevole riduzione degli ingombri
 - Permette la rotazione di 360° del motore o del cambio
 - Garantisce la massima sicurezza e stabilità durante gli interventi
- Portata massima: 450 kg



3014 SAR € 990,00 1 030140360

3014SAR/1

vasca di raccolta liquidi per 3014 SAR

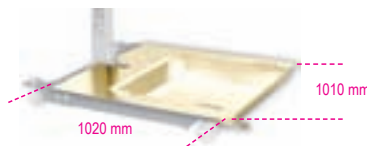

3014 SAR/1 € 280,00 1 030140361
1020x1010x11 mm

3014SAR/2

staffa per il fissaggio della trasmissione sul cavalletto 3014 SAR

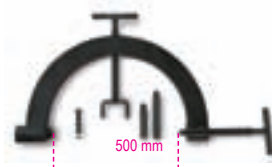

3014 SAR/2 € 290,00 1 030140362

3025

gru idraulica pieghevole con pompa a doppio effetto
Portata massima 1 t

CE



3025 3025 € 1.350,00 1 030250001

3026 0,5

sollevente idraulico da fossa e sottoponte

Portata massima 500 kg

CE



3026 0,5 € 625,00 1 030260005

3027

Pressa idraulica con pistone mobile da 20 tonnellate

Capacità massima: 20 t

CE



3027 € 1.750,00 1 030270020

3027/KP

serie di cacciaspine e piastra per pressa 3027

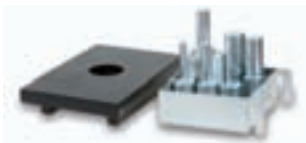

3027/KP € 360,00 1 030270520

3030/2T

sollevatore idraulico ribassato 2 t a 6 ruote

- doppie ruote anteriori basculanti in materiale plastico (PTFE)
- ottima manovrabilità del sollevatore su pavimentazioni sconnesse e irregolari
- portata massima: 2 tonnellate

CE



3030 € 560,00 1 030300020

43 kg

3030/2TRP

piattello di ricambio in gomma 85 mm per 3030/2T



3030/2TRP € 3,00 5 030300501

3040

cavalletto posteriore per moto regolabile

- Verniciatura nera opaca
- Porta cursore in poliammide
- 4 ruote in gomma termoplastica



3040 € 75,00 1 030400001

3040A/1

coppia cursori a V per 3040



3040A/1 € 31,00 1 030400501

3040A/2

coppia cursori a L in gomma per 3040



3040A/2 € 35,00 1 030400502

3040A/6-8-10

coppia nottolini in alluminio per 3040A/1



3040A/6 € 26,00 1 030400506

M6x1 mm
Aprilia, Yamaha, Triumph

3040A/8 € 26,00 1 030400508

M8x1.25 mm
Suzuki, Honda, Ducati

3040A/10 € 26,00 1 030400510

M10x1.25 mm
Kawasaki

3041

cavalletto anteriore per moto regolabile

- Verniciatura nera opaca
- Porta cursore in poliammide
- 4 ruote in gomma termoplastica



3041 € 75,00 1 030410001

3041A/11

coppia cursori a rulli per 3041



3041 A/11 € 51,00 1 030410511

3041A/15

coppia cursori a cono per 3041



3041 A/15 € 28,00 1 030410515

3042

cavalletto anteriore per canotto di sterzo moto

- Verniciatura nera opaca
- 4 ruote in gomma termoplastica
- Include kit di 6 perni



3042 € 225,00 1 030420001

3042/K6P

kit di 6 perni per cavalletto moto 3042

(già inclusi nel 3042)



3042/K6P € 85,00 1 030420101

3043

cavalletto per moto con monobraccio sinistro

- Porta cursore in acciaio
- Verniciatura nera opaca
- 4 ruote in gomma termoplastica



3043 € 175,00 1 030430001

3043A/41÷47

perno per 3043



3043A/41 € 33,00 1 030430541

Ducati

3043A/42 € 33,00 1 030430542

Triumph

3043A/43 € 50,00 1 030430543

MV

3043A/44 € 50,00 1 030430544

Ducati 1098

3043A/45 € 33,00 1 030430545

Honda

3043A/46 € 47,00 1 030430546

BMW F800S

3043A/47 € 82,00 1 030430547

BMW K,R,S

Beta



UTENSILI ISOLATI

Gli utensili isolati Beta sono prodotti studiati per garantire la sicurezza di installatori e manutentori elettrici.

Tutti gli utensili isolati permettono di operare su impianti in tensione fino a 1000V in corrente alternata e 1500V in corrente continua.

Per garantire il massimo livello di qualità e di prestazioni e accertare l'idoneità e la conformità alla norma EN 60900, **ogni singolo utensile è sottoposto a un approfondito processo di verifica**

che comprende: prove di resistenza dell'impugnatura allo sfilamento e alla propagazione della fiamma e prova di tensione applicata a 10000 Volt.

Per assortimenti e termofornati vedere le rispettive sezioni.

52MQ

chiavi a forchetta semplici



EN 60900

Ø mm	L mm	€	1	000520110
10	110	23,00	1	000520110
11	120	23,00	1	000520111
12	132	24,00	1	000520112
13	140	25,00	1	000520113
14	146	26,00	1	000520114
15	166	27,00	1	000520115
17	168	28,00	1	000520117
19	176	30,00	1	000520119
22	200	32,00	1	000520122
24	225	36,00	1	000520124

89MQ

chiavi poligonali semplici



EN 60900

Ø mm	L mm	€	1	000890110
10	170	30,00	1	000890110
11	180	30,00	1	000890111
12	190	35,00	1	000890112
13	195	35,00	1	000890113
14	200	38,00	1	000890114
15	210	38,00	1	000890115
17	218	40,00	1	000890117
19	240	41,00	1	000890119
22	255	51,00	1	000890122
24	280	56,00	1	000890124

110MQ

chiave regolabile a rullino con scala graduata



EN 60900

L mm	A max mm	€	1	001100525
250	30	68,00	1	001100525

606MQ/50

chiave dinamometrica a scatto con cricchetto reversibile



EN 60900
UNI EN 26789
ISO 6789

Nm	Kgfm	lbf.ft	L1 mm	L mm	g
5÷50	0,5÷5	4÷40	90	375	1130

606MQ/50 € 678,00 1 006060705

850MQ

portainseri magnetico isolato con impugnatura bimateriale

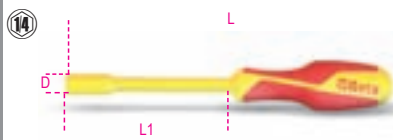

IMQ CSV

L mm	L1 mm	D mm	€	1	008500910
233	125	12.5	15,00	1	008500910

920MQ/A

chiavi a bussola esagonali



EN 60900

Ø mm	L mm	Ø1 mm	€	1	009200238
8	21,5	57	27,5	21,50	1 009200238
10	21,5	57	27,5	21,50	1 009200240
11	21,5	57	27,5	21,50	1 009200241
12	23,0	57	27,5	21,50	1 009200242
13	23,0	57	27,5	21,50	1 009200243
14	23,0	57	27,5	22,50	1 009200244
17	30,0	57	27,5	22,50	1 009200247
19	32,2	57	27,5	23,00	1 009200249
22	36,0	57	27,5	25,50	1 009200252
24	39,0	57	27,5	25,50	1 009200254

920MQ/PE

chiavi a bussola maschio esagonale

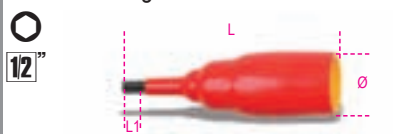

EN 60900

Ø mm	L mm	L1 mm	€	1	009200265
5	28.5	94.5	10.5	36,00	1 009200265
6	28.5	94.5	10.5	36,00	1 009200266
8	28.5	94.5	10.5	36,00	1 009200268

920MQ/21

prolunga quadro maschio e femmina 1/2"



EN 60900

L mm	Ø mm	€	1	009200804
135	28	42,00	1	009200804

920MQ/22

prolunga quadro maschio e femmina 1/2"



EN 60900

L mm	Ø mm	€	1	009200805
264	30	47,00	1	009200805

920MQ/T

quadro maschio 1/2", a T



EN 60900

L mm	L1 mm	€	1	009200807
200	163	48,50	1	009200807

920MQ/55A

cricchetto reversibile con attacco quadro maschio 1/2" con sistema di bloccaggio bussola



EN 60900

L mm	D mm	A mm	€	1	009200809
240	50	89	186,00	1	009200809

920MQ/C16

9 chiavi a bussola esagonali
3 chiavi a bussola esagonali maschio e 4 accessori



EN 60900

920MQ/C16	€	1	009200917
920MQ/C16	674,00	1	009200917

- 920MQ/A 8 - 10 - 12 - 13 - 14 - 17 - 19 - 22 - 24 mm
- 920MQ/PE 5 - 6 - 8 mm
- 920MQ/21 135 mm
- 920MQ/22 264 mm
- 920MQ/55A
- 920MQ/T

420x280x60 mm - 5,2 kg

943MQ

chiavi a bussola esagonale con impugnatura

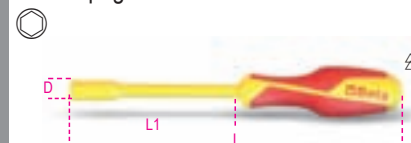

EN 60900

Ø mm	L mm	L1 mm	D mm	€	1	009430235
5,5	233	125	12,2	13,00	1	009430235
6	233	125	12,5	13,00	1	009430236
7	240	125	14,3	14,00	1	009430237
8	240	125	15,3	14,50	1	009430238
10	252	125	17,3	15,00	1	009430240
13	252	125	21,3	16,50	1	009430243

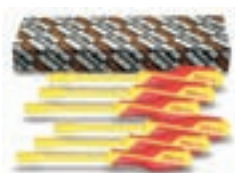

943MQ/S6 € 86,00 1 009430250
5,5-6-7-8-10-13 mm

951MQ

chiavi a T maschio esagonale

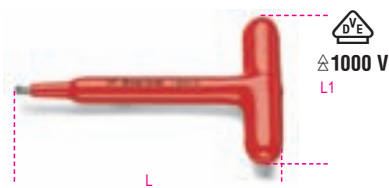

EN 60900

mm	L mm	L1 mm	€	1	009510704
4	165	105	34,00	1	009510704
5	170	105	34,00	1	009510705
6	168	105	34,00	1	009510706
8	165	105	36,00	1	009510708

993MQ

pinzetta a molla a punta curve arrotondate, zigrinate



EN 60900

L mm	€	1	009930040
147	28,00	1	009930040

994MQ

pinzetta a molla a punta diritte arrotondate, zigrinate



EN 60900

L mm	€	1	009940040
145	27,00	1	009940040

1010MQ

pinze a becchi tondi lunghi



EN 60900

L mm	L1 mm	€	1	010100096
160	51,5	35,00	1	010100096

1048MQ

pinze regolabili a cerniera chiusa

• Finitura cromata



EN60900

L mm	A max mm	L1 mm	€	1	010480315
250	54	39	46,00	1	010480315

1082MQ

tronchesi a taglienti diagonali



EN 60900

L mm	L1 mm	mm	€	1	010820094
140	20	1,6	32,50	1	010820094
160	22	1,6	35,50	1	010820096

1084MQ

tronchesi a grande effetto a taglienti diagonali



EN 60900

L mm	L1 mm	mm	€	1	010840100
200	26	2,0	45,50	1	010840100

1088MQ

tronchesi a taglienti frontali

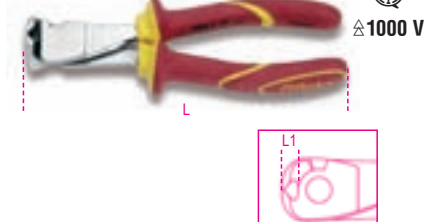

EN 60900

L mm	L1 mm	mm	€	1	010880096
160	7	1,6	41,00	1	010880096

1127MQ

forbici per elettricisti
lame in acciaio
con microdentatura



L mm	L1 mm	€	1	011270101
180	40	37,00	1	011270101

1132MQ

tagliacavi
per cavi flessibili in rame e alluminio



EN 60900

L mm	mm	€	1	011320193
230	17	68,50	1	011320193

1142MQ

pinza spellafili



EN 60900

L mm	mm ²	€	1	011420096
160	0,5÷6	39,00	1	011420096

1150MQ

pinze universali
cromate lucide



EN 60900

L mm	L1 mm	mm	€	1	011500096
160	37	1,6	31,50	1	011500096
180	39	1,8	34,00	1	011500098
200	43	2,0	37,00	1	011500100
220	46	2,0	39,00	1	011500102

1162MQ

pinze a becchi piatti
lunghissimi diritti



EN 60900

L mm	L1 mm	mm	€	1	011620096
160	56	1,6	33,50	1	011620096
200	76	1,6	36,50	1	011620100

1164MQ

pinze a becchi piatti
lunghissimi piegati



L	L1	mm	€	🔧	📦
160	54	1,6	35,00	1	011640096
200	76	1,6	38,50	1	011640100

1166MQ

pinze a becchi mezzotondi
lunghissimi dritti

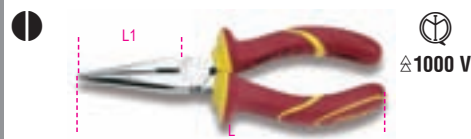

EN 60900

L	L1	mm	€	🔧	📦
160	56	1,6	33,50	1	011660096
200	76	1,6	36,50	1	011660100

1168MQ

pinze a becchi mezzotondi
lunghissimi piegati



EN 60900

L	L1	mm	€	🔧	📦
160	50	1,6	35,00	1	011680096
200	70	1,6	38,50	1	011680100

1272MQ

giravite per viti con impronta
a croce Phillips®

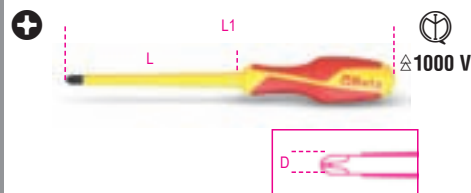

EN 60900

PHxDxL	L1	mm	€	🔧	📦
0x3x60	160		6,90	3	012720703
1x4,5x80	187		8,10	3	012720709
2x6x100	218		9,50	3	012720718
3x8x150	276		12,00	2	012720724
4x10x200	326		14,00	2	012720727

1273MQ/D6

serie di 6 giravite



1273MQ/D6 48,00 1 012730851

1274MQ 0,5x3x100 -0,8x4x100
1,0x5,5x125 mm

1272MQ PH0x3x60 -PH1x4,5x80
PH2x6x100 mm

1274MQ

giravite per viti senza testa
con intaglio

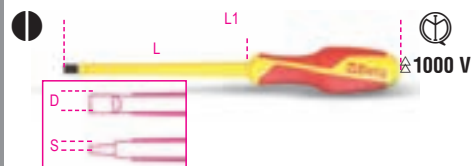

EN 60900

SxDxL	L1	mm	€	🔧	📦
0,4x2,5x75	175		6,40	3	012740700
0,5x3x100	200		6,80	3	012740703
0,8x4x100	207		7,80	3	012740706
1x5,5x125	232		8,70	3	012740709
1,2x6,5x150	268		10,30	3	012740712
1,2x8x175	301		12,30	2	012740715
1,6x10x200	326		14,00	2	012740718



1274MQ/S6 60,00 1 012740751

0,5x3x100-0,8x4x100
1x5,5x125-1,2x6,5x150
1,2x8x175-1,6x10x200 mm

1279MQ

giravite per viti con impronta a croce
Pozidriv®-Supadriv®



EN 60900

PZ	L	L1	mm	€	🔧	📦
0	60	160		7,30	3	012790703
1	80	187		8,50	3	012790709
2	100	218		10,00	3	012790718
3	150	276		12,30	2	012790724

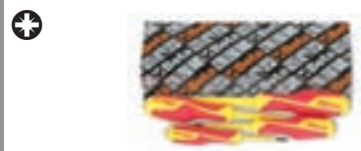

1279MQ/S4 38,00 1 012790751

PZ 0-1-2-3

1725MQ

miniseghetto



1725MQ L mm 260 H mm 85 € 67,00 1 017250030

1777MQ/C

coltello spellacavi isolato

• per cavi multipolari



1777MQ/C L mm 190 € 24,00 1 017770026

1777MQ/U

coltello spellacavi isolato



1777MQ/U L mm 190 € 21,00 1 017770011

1777RL/U

4 lame di ricambio per cutter 1777MQ/U



1777RL/U € 18,50 1 017770021

1995MQ/T

tappeto isolante

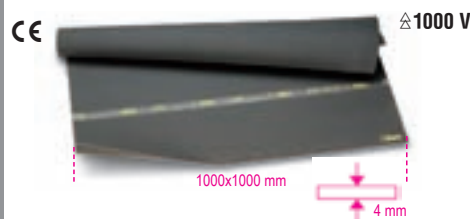

VDE 0303

1995MQ/T LxSxH mm 1000x1000x4 € 225,00 1 019950030

1995MQ/G1 - G2

guanti isolanti, in lattice



EN 60903

	Gr.	L	mm	€	🔧	📦
1995MQ/G1	9	410		90,00	1	019950010
1995MQ/G2	10	410		90,00	1	019950013



Beta INOX STAINLESS STEEL



INOX + NO INOX =
RUGGINE



INOX + INOX =
NO RUGGINE

Gli utensili **BETA INOX** possono essere utilizzati in **ambienti critici**, ovvero zone e aree in cui non è ammesso il livello minimo di contaminazione.

Alcuni esempi sono:

- Applicazioni nucleari
- Produzione farmaceutica
- Applicazioni offshore
- Laboratori biotecnologici e biomedici
- Industria alimentare.

Gli utensili Beta Inox evitano, inoltre, il fenomeno della **ruggine impropria**.

Quando si utilizzano utensili non realizzati in acciaio inossidabile su viti, dadi o superfici in acciaio inossidabile, dagli utensili si possono staccare particelle che innescano processi di corrosione, creando spesso problemi estetici, e, alcune volte, problemi strutturali.

Esempi di applicazione sono:

- Cantieri navali,
- Edilizia,
- Impianti solari,
- Industria automobilistica.

CARATTERISTICHE

L'accurata scelta dei materiali¹ e la sapiente ricerca dei migliori trattamenti termici conferiscono agli utensili Beta Inox **caratteristiche meccaniche** ampiamente superiori ai valori di norma e comparabili a quelle dei normali utensili Beta.

L'ergonomia e il design dei prodotti sono gli stessi degli utensili Beta, conosciuti e apprezzati dagli utilizzatori professionali da più di 75 anni.

L'acciaio inossidabile è riciclabile al 100%. Anche questa è una caratteristica importante.

¹ Beta Utensili utilizza acciaio AISI 420, magnetico.

42INOX

chiavi combinate,
in acciaio inossidabile



mm	L mm	€		
8x8	116	9,50	2	000420308
10x10	137	10,00	2	000420310
11x11	148	10,50	2	000420311
12x12	158	11,00	2	000420312
13x13	169	12,00	2	000420313
14x14	180	12,50	2	000420314
15x15	190	13,00	2	000420315
17x17	212	14,00	2	000420317
19x19	233	16,00	2	000420319



	€		
42INOX/SC9 8-10-11-12-13-14-15-17-19 mm	115,00	1	000420387
42/SCV9I	8,00	1	000420103

96BPINOX

chiavi maschio esagonale piegate con
estremità sferica,
in acciaio inossidabile



mm	L mm	L1 mm	€		
2,5	91	22	3,50	4	000961442
3	101	24	3,70	4	000961443
4	112	29	3,90	4	000961444
5	131	33	4,90	4	000961445
6	154	36	5,20	4	000961446
8	175	44	8,50	2	000961448
10	197	51	11,00	2	000961450



	€		
96BPINOX/B7 2,5-3-4-5-6-8-10 mm	44,50	1	000961454
96/BV	4,00	1	000961459

96TINOX

chiavi maschio esagonale piegate
con impugnatura di manovra,
in acciaio inossidabile

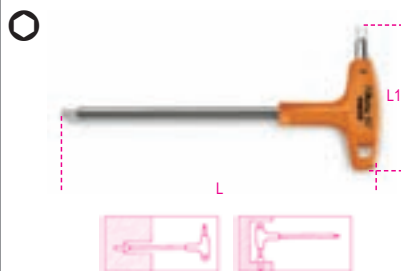

mm	L mm	L1 mm	€		
2,5	153	55	9,50	2	000961935
3	153	55	10,00	2	000961936
4	179	70	10,50	2	000961938
5	200	84	11,50	2	000961940
6	221	95	12,50	2	000961941



	€		
96TINOX/S5 2,5-3-4-5-6 mm	54,00	1	000961952

1290INOX

giravite per viti a testa con intaglio
in acciaio inossidabile

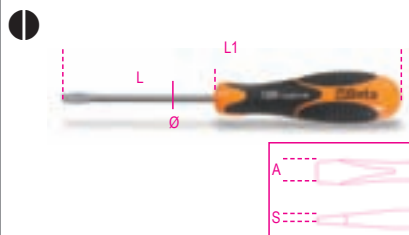

SxAxL mm	L1 mm	Ø mm	€		
0.4x2.5x50	146	2.5	5,70	4	012900403
0.5x3x75	171	3.0	6,00	4	012900409
0.8x4x100	196	4.0	7,00	4	012900430
1.x5.5x150	259	5.0	9,00	4	012900442
1.2x6.5x150	270	6.0	10,50	4	012900451

1292INOX

giravite per viti con impronta a croce Phillips®,
in acciaio inossidabile

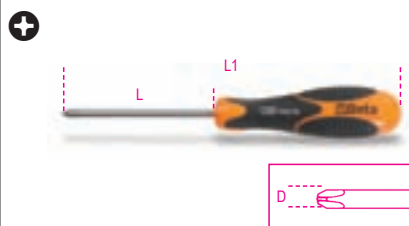

PHxDxL mm	L1 mm	€		
0x3x60	156	5,50	4	012920403
1x4.5x80	189	7,50	4	012920409
2x6x100	220	9,50	4	012920418

1293INOX/D8

serie giravite
in acciaio inossidabile



	€		
1293INOX/D8	60,50	1	012930408
1290INOX			2,5x50-3x75
1292INOX			4x100-5,5x150-6,5x150 mm PH0x60-PH1x80 PH2x100 mm



Beta

UTENSILI ANTISCINTILLA RAME-BERILLIO Cu-Be



Gli utensili antiscintilla Beta sono certificati dall'Istituto per la ricerca e il collaudo BAM, secondo la Direttiva Europea 99/92/EC.



CLASSIFICAZIONE DELLE ZONE A RISCHIO DI ESPLOSIONE			
ATEX	ALTA	MEDIO BASSA	MOLTO BASSA
GAS	ZONA 0 Area in cui è presente in permanenza o per lunghi periodi o spesso, un'atmosfera esplosiva consistente in una miscela di aria e di sostanze infiammabili sotto forma di gas, vapore o nebbia.	ZONA 1 Area in cui durante le normali attività è probabile la formazione di un'atmosfera esplosiva consistente in una miscela di aria e di sostanze infiammabili sotto forma di gas, vapore o nebbia.	ZONA 2 Area in cui durante le normali attività non è probabile la formazione di un'atmosfera esplosiva consistente in una miscela di aria e di sostanze infiammabili sotto forma di gas, vapore o nebbia e, qualora si verifici, sia unicamente di breve durata.
	POLVERI	ZONA 20 Area in cui è presente in permanenza o per lunghi periodi o spesso un'atmosfera esplosiva sotto forma di nube di polvere combustibile nell'aria.	ZONA 21 Area in cui occasionalmente durante le normali attività è probabile la formazione di un'atmosfera esplosiva sotto forma di nube di polvere combustibile nell'aria.

Gli utensili Antiscintilla **Beta** sono specifici per operare in assoluta sicurezza in ambienti a potenziale rischio di esplosioni, con presenza di liquidi o gas infiammabili, o per applicazioni che richiedono l'utilizzo di utensili amagnetici e resistenti alla corrosione.

Composizione	Be	1,8 ÷ 2,3%
	Co+Ni	Min 0,2 %
	Co+Ni+Fe	Max 1,2 %
	Cu	A compensazione
Durezza	310 ÷ 360 Brinell	
Resistenza alla trazione	1050 ÷ 1200 N/mm ²	
Limite di snervamento	840 ÷ 880 N/mm ²	



ATTENZIONE: rischio di esplosione in presenza di ACETILENE.

30BA

punzoni antiscintilla



Ø mm	L mm	€	🔧	📦
5	150	44,00	1	000300806
8	150	53,00	1	000300808
10	150	69,00	1	000300810

31BA

cacciaspina antiscintilla



Ø mm	L mm	€	🔧	📦
3	110	19,00	1	000310853
4	110	40,00	1	000310854
6	115	62,00	1	000310856
8	120	72,00	1	000310858

34BA

scalpelli piatti antiscintilla



L mm	A mm	€	🔧	📦
200	22	88,00	1	000340801
300	24	172,00	1	000340802

39BA

cunei antiscintilla



L mm	A mm	€	🔧	📦
150	40	35,00	1	000390801
230	40	115,00	1	000390802
250	40	185,00	1	000390803

42BA

chiavi combinate antiscintilla



Ø mm	L mm	€	🔧	📦
6x6	105	40,00	1	000420806
7x7	105	44,00	1	000420807
8x8	120	49,00	1	000420808
9x9	120	55,00	1	000420809
10x10	135	60,00	1	000420810
11x11	135	64,00	1	000420811
12x12	150	69,00	1	000420812
13x13	150	72,00	1	000420813
14x14	175	75,00	1	000420814
15x15	175	79,00	1	000420815
16x16	195	82,00	1	000420816
17x17	200	88,00	1	000420817

Ø mm	L mm	€	🔧	📦
19x19	220	99,00	1	000420819
20x20	230	105,00	1	000420820
21x21	240	110,00	1	000420821
22x22	250	118,00	1	000420822
24x24	268	137,00	1	000420824
27x27	290	170,00	1	000420827
30x30	313	215,00	1	000420830
32x32	333	240,00	1	000420832
35x35	360	280,00	1	000420835
36x36	355	295,00	1	000420836
38x38	430	325,00	1	000420838
41x41	430	375,00	1	000420841
46x46	480	442,00	1	000420846
50x50	520	465,00	1	000420850
55x55	560	505,00	1	000420855
60x60	580	542,00	1	000420860
*65x65	595	599,00	1	000420865
*70x70	630	720,00	1	000420870

42BA/AS

chiavi combinate antiscintilla



Ø mm	L mm	€	🔧	📦
3/8x3/8	128	57,00	1	000420950
7/16x7/16	135	66,00	1	000420951
1/2x1/2	140	76,00	1	000420953
9/16x9/16	163	81,00	1	000420954
5/8x5/8	177	96,00	1	000420956
11/16x11/16	195	106,00	1	000420957
3/4x3/4	215	108,00	1	000420959
13/16x13/16	230	125,00	1	000420961
7/8x7/8	235	130,00	1	000420962
15/16x15/16	256	144,00	1	000420964
1x1	266	156,00	1	000420965
1.1/16x1.1/16	283	178,00	1	000420967
1.1/8x1.1/8	297	236,00	1	000420969
1.3/16x1.3/16	308	256,00	1	000420970
1.1/4x1.1/4	324	303,00	1	000420973

55BA

chiavi a forchetta doppie antiscintilla

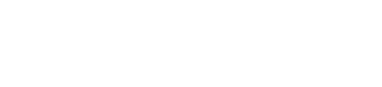

Ø mm	L mm	€	🔧	📦
6x7	90	27,00	1	000550801
8x9	100	29,00	1	000550802
10x11	120	34,50	1	000550803
12x13	130	41,00	1	000550804
14x15	145	49,00	1	000550805
16x17	165	53,00	1	000550807
18x19	170	73,00	1	000550809
20x22	185	84,00	1	000550811
21x23	210	90,00	1	000550813
22x24	210	105,00	1	000550815
24x26	230	130,00	1	000550817
24x27	230	138,00	1	000550818
25x28	230	145,00	1	000550819
27x29	246	170,00	1	000550820
30x32	265	198,00	1	000550822
36x38	320	256,00	1	000550826
36x41	335	290,00	1	000550828
41x46	355	352,00	1	000550829
*46x50	370	400,00	1	000550830
*50x55	385	430,00	1	000550831
*55x60	415	540,00	1	000550832

55BA/AS

chiavi a forchetta doppie antiscintilla



Ø mm	L mm	€	🔧	📦
3/8x7/16	110	37,00	1	000550853
1/2x9/16	130	43,00	1	000550854
5/8x11/16	160	62,00	1	000550857
3/4x13/16	180	76,00	1	000550859
7/8x15/16	210	106,00	1	000550865
1x1.1/16	230	146,00	1	000550868
1.1/8x1.3/16	245	193,00	1	000550870
1.1/4x1.5/16	255	226,00	1	000550872

58BA

chiavi a forchetta semplici a percussione, antiscintilla



Ø mm	L mm	€	🔧	📦
17	125	73,00	1	000580817
19	125	77,00	1	000580819
22	135	81,00	1	000580822
24	150	91,00	1	000580824
27	165	112,00	1	000580827
30	180	141,00	1	000580830
32	190	164,00	1	000580832
36	210	194,00	1	000580836
38	220	212,00	1	000580838
41	230	241,00	1	000580841
46	240	287,00	1	000580846
50	255	323,00	1	000580850
*55	305	400,00	1	000580855
*60	315	460,00	1	000580860

Beta

ISO 9001

78BA

chiavi poligonali a percussione, antiscintilla



mm	L mm	€		
17	145	83,00	1	000780817
19	145	90,00	1	000780819
22	165	92,00	1	000780822
24	140	99,00	1	000780824
27	155	118,00	1	000780827
30	165	137,00	1	000780830
32	180	147,00	1	000780832
34	192	170,00	1	000780834
36	208	186,00	1	000780836
38	215	222,00	1	000780838
41	225	244,00	1	000780841
46	245	276,00	1	000780846
50	250	318,00	1	000780850
55	265	376,00	1	000780855
60	275	406,00	1	000780860
65	295	452,00	1	000780865
70	310	496,00	1	000780870
75	325	557,00	1	000780875
80	340	589,00	1	000780880

78BA/AS

chiavi poligonali a percussione, antiscintilla



mm	L mm	€		
1.1/4	177	160,00	1	000780910
1.7/16	208	208,00	1	000780912
1.5/8	225	278,00	1	000780914
1.13/16	243	312,00	1	000780916
2	254	368,00	1	000780918
2.3/16	264	432,00	1	000780920
2.3/8	275	471,00	1	000780922
*2.9/16	286	485,00	1	000780924
*2.15/16	311	550,00	1	000780926
*3.1/8	325	684,00	1	000780928
*3.1/2	355	876,00	1	000780930

89BA

chiavi poligonali semplici, antiscintilla



mm	L mm	€		
10	200	96,00	1	000890810
11	210	98,00	1	000890811
12	220	101,00	1	000890812
13	230	104,00	1	000890813
14	240	106,00	1	000890814
16	260	112,00	1	000890816
17	270	118,00	1	000890817
18	280	125,00	1	000890818
19	300	132,00	1	000890819
20	310	142,00	1	000890820
22	330	154,00	1	000890822
24	350	178,00	1	000890824
27	370	220,00	1	000890827
30	400	240,00	1	000890830
32	420	256,00	1	000890832

90BA

chiavi poligonali doppie antiscintilla



mm	L mm	€		
10x11	155	42,00	1	000900803
12x13	175	51,00	1	000900806
14x17	220	63,00	1	000900809
16x18	235	73,00	1	000900812
18x19	265	84,00	1	000900815
20x22	295	99,00	1	000900818
22x24	315	126,00	1	000900821
24x27	340	158,00	1	000900823
30x32	395	227,00	1	000900824
34x36	410	343,00	1	000900826
*36x41	450	430,00	1	000900828
*41x46	470	525,00	1	000900829
*46x50	490	570,00	1	000900830

91BA

chiavi poligonali curve antiscintilla



mm	Ø mm	€		
24	38	175,00	1	000910824
27	42	230,00	1	000910827
30	48	265,00	1	000910830
32	49	295,00	1	000910832
36	54	325,00	1	000910836
41	62	360,00	1	000910841
*46	69	460,00	1	000910846
*50	75	520,00	1	000910850
*55	82	670,00	1	000910855



92BA

leve di manovra per art. 91BA, antiscintilla



	L mm	91BA mm	Ø mm	€		
92BA/1	460	34÷30	25	205,00	1	000920810
92BA/2	610	32÷41	28	265,00	1	000920820
*92BA/3	760	46÷55	32	360,00	1	000920830

93BA

chiave a cricchetto per ponteggi, antiscintilla



mm	L mm	€		
21x22	345	500,00	1	000930821

95BA

chiavi poligonali doppie dritte, antiscintilla



mm	L mm	€		
7x9	115	27,00	1	000950801
10x11	140	33,00	1	000950804
14x17	165	53,00	1	000950807
*16x18	170	69,00	1	000950809
*18x19	185	76,00	1	000950810
*21x23	230	105,00	1	000950815
*24x27	255	130,00	1	000950817

96BA

chiavi maschio esagonale piegate antiscintilla

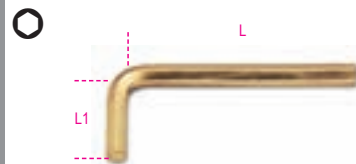

mm	L mm	L1 mm	€		
2	50	16	57,00	1	000960762
3	63	21	62,00	1	000960763
4	69	25	65,00	1	000960764
5	78	29	67,00	1	000960765
6	88	33	69,00	1	000960766
7	93	34	72,00	1	000960767
8	97	36	75,00	1	000960768
9	104	37	78,00	1	000960769
10	110	39	81,00	1	000960770
12	122	44	104,00	1	000960772

96BA/BP

chiavi maschio esagonale piegate con estremità sferica, antiscintilla



mm	L mm	L1 mm	€		
3	60	20	65,00	1	000961803
4	66	25	68,00	1	000961804
5	75	28	70,00	1	000961805
6	84	32	72,00	1	000961806
8	92	36	78,00	1	000961808
10	102	40	84,00	1	000961810
12	113	45	107,00	1	000961812

99BA

chiavi a settore con nasello quadro per ghiera antiscintilla



mm	A mm	€		
32-75	4,0	155,00	1	000990803
50-120	4,5	230,00	1	000990805
115-170	4,5	360,00	1	000990811

110BA

chiavi regolabili a rullino, antiscintilla



L mm	A max mm	€		
150	18	115,00	1	001100815
200	24	144,00	1	001100820
250	32	168,00	1	001100825
300	39	240,00	1	001100830
375	48	313,00	1	001100837
*450	55	445,00	1	001100845

330BA

tagliatubi per tubi gas, antiscintilla

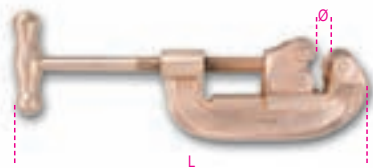

330BA/2	Ø max mm	L mm	€		
	50	375	594,00	1	003300802

363BA

giratubi modello americano, antiscintilla



L mm	Ø max mm	Ø max mm	€		
250	1" gas	34	216,00	1	003630825
300	1 1/2" gas	49	255,00	1	003630830
350	2" gas	60	328,00	1	003630835
450	2 1/2" gas	76	502,00	1	003630845
600	3" gas	90	725,00	1	003630860

378BA

giratubi modello svedese, antiscintilla



L mm	Ø max mm	€		
430	1" 1/2	590,00	1	003780800
530	2"	720,00	1	003780801

386BA

giratubi reversibili a catena modello pesante, antiscintilla



L mm	Ø max mm	L1 mm	€		
600	100	470	865,00	1	003860806
900	200	750	1.460,00	1	003860809

921BA

chiavi a bussola poligonali, antiscintilla

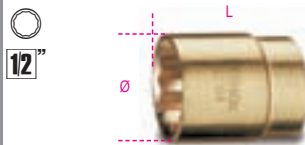

Ø mm	Ø mm	L mm	€		
10	16,5	40	69,00	1	009210810
11	17,5	40	75,00	1	009210811
12	18,5	40	77,00	1	009210812
13	19,5	40	81,00	1	009210813
14	20,0	40	82,00	1	009210814
15	21,5	40	85,00	1	009210815
16	24,0	40	88,00	1	009210816
17	25,0	40	91,00	1	009210817
18	25,0	40	93,00	1	009210818
19	28,0	42	97,00	1	009210819
20	29,0	42	98,00	1	009210820
21	30,0	43	101,00	1	009210821
22	30,5	43	104,00	1	009210822
24	34,0	43	122,00	1	009210824
25	36,0	43	134,00	1	009210825
26	37,5	43	142,00	1	009210826
27	37,5	45	149,00	1	009210827
28	38,9	46	155,00	1	009210828
30	41,5	46	173,00	1	009210830
32	43,5	46	191,00	1	009210832

921BA/21 - 921BA/22

prolunghe con attacchi quadri maschio e femmina 1/2", antiscintilla



	L mm	Ø mm	€		
921BA/21	125	30	90,00	1	009210842
921BA/22	250	31	124,00	1	009210844

921BA/42

quadro maschio 1/2" con spina scorrevole, antiscintilla

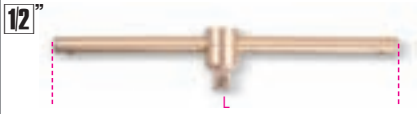

L mm	€		
250	156,00	1	009210846

921BA/25

snodo con attacchi quadri maschio e femmina 1/2", antiscintilla



L mm	Ø mm	1/2	1/2	€		
80	25	1/2	1/2	94,00	1	009210845

921BA/50

cricchetto semplice con quadro scorrevole 1/2", antiscintilla



L mm	D mm	A mm	€		
250	45	16,5	193,00	1	009210850

926BA

chiavi a bussola poligonali, antiscintilla



Ø mm	Ø mm	L mm	€		
24	40	55	143,00	1	009260824
26	40	55	164,00	1	009260826
27	40	55	173,00	1	009260827
28	41	55	182,00	1	009260828
30	43	60	205,00	1	009260830
32	45	60	232,00	1	009260832
34	48	60	249,00	1	009260834
36	50	60	268,00	1	009260836
38	53	60	285,00	1	009260838
41	57	65	314,00	1	009260841
46	63	65	370,00	1	009260846
50	68	70	405,00	1	009260850

926BA/22

prolunghe con attacchi quadri maschio e femmina 3/4", antiscintilla



	L mm	Ø mm	€		
926BA/22	200	38	203,00	1	009260872

926BA/42

quadro maschio 3/4" con spina scorrevole, antiscintilla

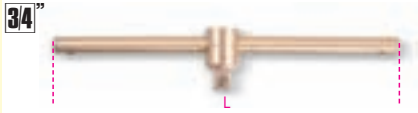

	L mm	€		
926BA/42	400	262,00	1	009260876

926BA/50

cricchetto semplice con quadro scorrevole 3/4", antiscintilla



	L mm	D mm	S mm	€		
926BA/50	300	61	22	300,00	1	009260880

937BA

chiavi a pipa esagonali, antiscintilla



	L mm	A mm	€		
13	240	45	70,00	1	009370813
17	260	51	100,00	1	009370817
19	270	55	105,00	1	009370819
22	278	59	140,00	1	009370822
24	286	63	150,00	1	009370824
27	294	69	160,00	1	009370827
30	302	75	175,00	1	009370830
32	310	81	192,00	1	009370832
*36	330	85	225,00	1	009370836
*41	350	90	275,00	1	009370841

961BA

leve scrostatore, antiscintilla



	L mm	A mm	€		
961BA	250	39	100,00	1	009610802
961BA	350	55	150,00	1	009610806

963BA

leva con estremità a punta e piatta curva, antiscintilla



	L mm	A mm	€		
963BA	500	24	275,00	1	009630801
*800	24		445,00	1	009630803
*1000	30		950,00	1	009630805

964BA

aprifusti antiscintilla



	L mm	€		
964BA	385	275,00	1	009640801

964BA/L

cesoia universale per fusti, antiscintilla

Per l'apertura dei fusti metallici con bordo



	L mm	€		
964BA/L	510	1.390,00	1	009640821



965BA

chiavi di manovra semplici antiscintilla, per valvole di sicurezza



	A mm	A1 mm	L mm	€		
965BA	30	44	200	123,00	1	009650830
965BA	32	50	300	169,00	1	009650832
965BA	35	47	250	137,00	1	009650835
965BA	40	50	300	159,00	1	009650840
965BA	45	58	350	206,00	1	009650845
965BA	48	62	375	217,00	1	009650848
965BA	50	67	400	236,00	1	009650850
965BA	55	73	450	282,00	1	009650855
965BA	60	79	500	303,00	1	009650860
*65	82	550	345,00	1	009650865	
*70	85	600	380,00	1	009650870	

966BA

chiave di manovra antiscintilla, per valvole di sicurezza

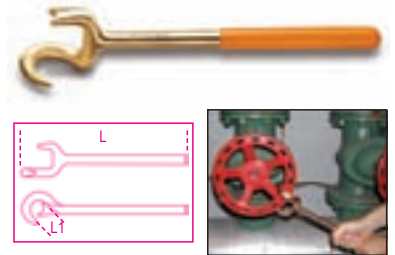

	L mm	L1 mm	€		
966BA	350	40	255,00	1	009660801

966BA/V

chiave di manovra antiscintilla, per valvole di sicurezza

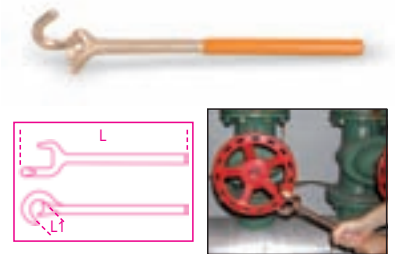

	L mm	L1 mm	€		
966BA/V	370	36	255,00	1	009660812
966BA/V	430	48	385,00	1	009660814

1046BA

pinza regolabile cerniera a cremagliera, antiscintilla

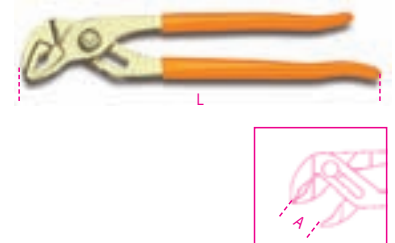

	L mm	A max mm	€		
1046BA	250	32	212,00	1	010460801
*300	300	52	283,00	1	010460803

1082BA

tronchesi a taglienti diagonali,
antiscintilla



L mm	L1 mm	€		
160	22	152,00	1	010820801

1137BA

pinza da fochino,
antiscintilla



L mm	€		
185	295,00	1	011370801

1137BA/RC

lama di ricambio per 1137BA



1137BA/RC	€		
	57,00	1	011370851

1150BA

pinza universale,
antiscintilla

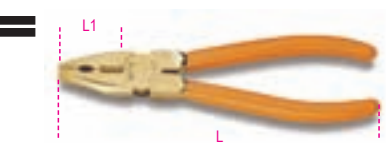

L mm	L1 mm	€		
200	40	178,00	1	011500820

1162BA

pinze a becchi piatti lunghissimi
diritti zigrinati,
antiscintilla



L mm	L1 mm	€		
150	54	140,00	1	011620815

1166BA

pinze a becchi mezzotondi
lunghissimi
diritti zigrinati,
antiscintilla



L mm	L1 mm	€		
150	54	140,00	1	011660815

1270BA

giravite per viti a testa con intaglio,
antiscintilla



AxL mm	L1 mm	€		
3x75	178	24,50	1	012700803
4x100	209	32,00	1	012700804
5x150	250	40,00	1	012700805
6x150	270	46,50	1	012700806
10x250	382	69,00	1	012700810
8x200	312	48,00	1	012700808

1272BA

giravite per viti
con impronta a croce Phillips®,
antiscintilla



PHxDxL mm	L1 mm	€		
1x5x100	209	35,00	1	012720801
2x6x150	270	46,00	1	012720802
3x8x200	332	54,00	1	012720803

1370BA

martelli tipo tedesco antiscintilla,
manico in legno



g	L1 mm	L mm	€	
500	108	310	93,00	1 013700805
1000	137	340	167,00	1 013700810

1370BA/MR

manici di ricambio per 1370BA

1370BA/MR500	€		
1370BA/500	16,00	1	013700865
1370BA/MR1000	20,00	1	013700870
1370BA/1000			

1377BA

martelli con testa tonda e penna sferica
per caldaia e lattonieri,
antiscintilla



g	L1 mm	L mm	€	
340	90	280	62,00	1 013770834

1379BA

martello scrostatore antiscintilla,
manico in legno



g	L1 mm	L mm	€	
500	142	315	119,00	1 013790850

1380BA

mazzette antiscintilla,
manico in legno



g	L1 mm	L mm	€	
1500	118	397	248,00	1 013800815
2000	126	449	325,00	1 013800820

1380BA/MR

manici di ricambio per 1380BA

1380BA/MR1500	€		
1380BA/1500	19,00	1	013800865
1380BA/MR2000	19,00	1	013800870
1380BA/2000			

1381BA

mazza antiscintilla,
manico in legno



g	L1 mm	L mm	€	
5000	179	900	750,00	1 013810850
*8000	190	900	1.160,00	1 013810858

1381BA/MR

manico di ricambio per 1381BA

1381BA/MR5000 1381BA/5000	€ 36,00	1	013810870
*1381BA/MR8000 1381BA/8000	€ 40,00	1	013810878

1390BA

mazzuola con battenti in plastica, antiscintilla



∅ mm	L mm	L1 mm	€	1	013900805
*52	370	130	160,00		

1701BA

scalpello esagonale, antiscintilla



L mm	A mm	S mm	€	1	017010810
150	12	10	38,00		
200	16	14	61,00		017010814
350	19	17	195,00		017010817

1703BA/P

piccone antiscintilla



A mm	L mm	L1 mm	€	1	017030150
56	410	1050	445,00		

1703BA/PL

badile antiscintilla

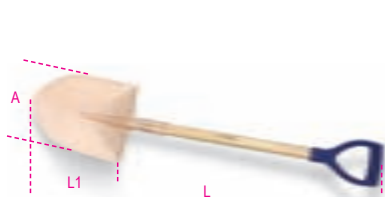

A mm	L1 mm	L mm	€	1	017030200
240	420	990	365,00		

1717BA

spatole rigide, antiscintilla



A mm	€	1	017170801
60	85,00		
80	95,00		017170803

1717BA/1

raschiapareti antiscintilla



A mm	L mm	€	1	017170805
100	220	179,00		

1719BA

lime da 8" antiscintilla



	L mm	€	1	017190801
1719BA/P	200	108,00		
1719BA/M	200	112,00		017190805
1719BA/R	200	115,00		017190810
1719BA/T	200	103,00		017190815
1719BA/Q	200	103,00		017190820

1727BA

seghetto e lama, antiscintilla



L mm	L1 mm	€	1	017270801
500	300	365,00		

1728BA

lama per seghetti, antiscintilla



L mm	€	1	017280801
300	72,00		

1737BA

spazzola con fili antiscintilla



L mm	A mm	€	1	017370801
294	29	43,00		

1776BA

coltello antiscintilla



L1 mm	L mm	€	1	017760801
145	250	98,00		

1784BA

forbici antiscintilla



L mm	€	1	017840822
225	176,00		

Beta

PNEUMATICA

In oltre 15 anni di lavoro Beta Utensili ha consolidato la propria esperienza nell'utensileria pneumatica, realizzando una gamma completa di prodotti destinati al mercato automotive e alla manutenzione industriale. L'offerta è completata da una sezione di accessori dedicati al trattamento aria con unità FRL da 1/4" a 1/2" e all'alimentazione dell'utensile con una vasta scelta di tubi in PU e raccordi rapidi.



Beta

1921B1

baby cricchetto reversibile

1/4"

CE



Velocità libera	350 giri/min
Coppia massima	24 Nm
Pressione di utilizzo	6,2 Bar
Consumo aria medio	68 l/min
Ø interno tubo aria	8 mm
Capacità vite/dado	CI 8.8 M7●11 mm
Capacità vite/dado	CI 12.9 M6●10 mm

1/4 450 € 177,00 1 019210001

1921N3

cricchetto reversibile

1/2"

CE



Velocità libera	150 giri/min
Coppia massima	68 Nm
Pressione di utilizzo	6,2 Bar
Consumo aria medio	140 l/min
Ø interno tubo aria	10 mm
Capacità vite/dado	CI 8.8 M10●16 mm
Capacità vite/dado	CI 12.9 M8●13 mm

1/2 1,22 € 157,00 1 019210025

1924B

avvitatore reversibile compatto

• Meccanismo impulsivo "Pin Clutch"

3/8"

CE



Velocità libera	10.000 giri/min
Coppia massima	353 Nm
Pressione di utilizzo	6,2 Bar
Consumo aria medio	80 l/min
Ø interno tubo aria	8 mm
Capacità vite/dado	CI 8.8 M16●24 mm
Capacità vite/dado	CI 12.9 M14●21 mm

3/8 1,5 € 198,00 1 019240021

1921M1

cricchetto compatto reversibile

1/4"

CE



Velocità libera	200 giri/min
Coppia massima	27 Nm
Pressione di utilizzo	6,2 Bar
Consumo aria medio	96 l/min
Ø interno tubo aria	8 mm
Capacità vite/dado	CI 8.8 M7●11 mm
Capacità vite/dado	CI 12.9 M6●10 mm

1/4 640 € 157,00 1 019210005

1921I

cricchetto reversibile a coppia elevata

1/2"

CE



Velocità libera	400 giri/min
Coppia massima	101 Nm
Pressione di utilizzo	6,2 Bar
Consumo aria medio	235 l/min
Ø interno tubo aria	10 mm
Capacità vite/dado	CI 8.8 M10●16 mm
Capacità vite/dado	CI 12.9 M8●13 mm

1/2 1,28 € 250,00 1 019210035

1924CD

avvitatore reversibile in materiale composito

• Meccanismo impulsivo doppio martello

3/8"

CE



Velocità libera	10000 giri/min
Coppia massima	410 Nm
Coppia d'esercizio	250 Nm
Pressione di utilizzo	6,2 Bar
Consumo aria medio	79 l/min
Ø interno tubo aria	8 mm
Capacità vite/dado	CI 8.8 M16●24 mm
Capacità vite/dado	CI 12.9 M14●21 mm

3/8 1,25 € 285,00 1 019240007

1921M2

cricchetto compatto reversibile

3/8"

CE



Velocità libera	200 giri/min
Coppia massima	27 Nm
Pressione di utilizzo	6,2 Bar
Consumo aria medio	96 l/min
Ø interno tubo aria	8 mm
Capacità vite/dado	CI 8.8 M7●11 mm
Capacità vite/dado	CI 12.9 M6●10 mm

3/8 640 € 157,00 1 019210015



1927CD

avvitatore reversibile in materiale composito

- Meccanismo impulsivo doppio martello



Velocità libera	7.000 giri/min
Coppia massima	1020 Nm
Pressione di utilizzo	6,2 Bar
Consumo aria medio	130 l/min
Ø interno tubo aria	10 mm
Capacità vite/dado	Cl 8.8 M22●34 mm
Capacità vite/dado	Cl 12.9 M18●27 mm

1/2 kg 1,9 € 340,00 1 019270007

1927MDA

avvitatore reversibile compatto

- Meccanismo impulsivo doppio martello



Velocità libera	11.000 giri/min
Coppia massima	680 Nm
Pressione di utilizzo	6,2 Bar
Consumo aria medio	160 l/min
Ø interno tubo aria	10 mm
Capacità vite/dado	Cl 8.8 M22●34 mm
Capacità vite/dado	Cl 12.9 M18●27 mm

1/2 kg 1,56 € 197,00 1 019270028

1927DA

avvitatore reversibile

- Meccanismo impulsivo doppio martello

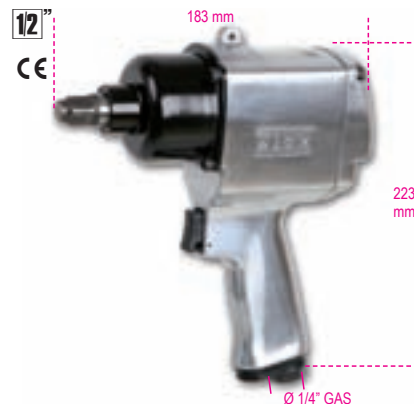

Velocità libera	7.000 giri/min
Coppia massima	650 Nm
Pressione di utilizzo	6,2 Bar
Consumo aria medio	155 l/min
Ø interno tubo aria	10 mm
Capacità vite/dado	Cl 8.8 M22●34 mm
Capacità vite/dado	Cl 12.9 M18●27 mm

1/2 kg 2,7 € 238,00 1 019270033

1927P

avvitatore reversibile in materiale composito

- Meccanismo impulsivo doppio martello



Velocità libera	7.500 giri/min
Coppia massima	1750 Nm
Pressione di utilizzo	6,2 Bar
Consumo aria medio	290 l/min
Ø interno tubo aria	9,5 mm
Capacità vite/dado	Cl 8.8 M24●36 mm
Capacità vite/dado	Cl 12.9 M20●30 mm

1/2 kg 2,0 € 380,00 1 019270008

1927A

avvitatore reversibile

- Meccanismo impulsivo "Pin Clutch"



Velocità libera	7000 giri/min
Coppia massima	610 Nm
Pressione di utilizzo	6,2 Bar
Consumo aria medio	160 l/min
Ø interno tubo aria	10 mm
Capacità vite/dado	Cl 8.8 M22●34 mm
Capacità vite/dado	Cl 12.9 M18●27 mm

1/2 kg 2,7 € 179,00 1 019270002

1927K4

assortimento di un avvitatore reversibile e quattro bussole a Macchina serie lunga

- Meccanismo impulsivo "Pin Clutch"



Velocità libera	7.000 giri/min
Coppia massima	610 Nm
Pressione di utilizzo	6,2 Bar
Consumo aria medio	175 l/min
Ø interno tubo aria	10 mm
Capacità vite/dado	Cl 8.8 M22●34 mm
Capacità vite/dado	Cl 12.9 M18●27 mm
Peso avvitatore	2,7 Kg

1/2 kg 4,65 € 264,00 1 019270104
360x320x85 mm

1928CD

avvitatore reversibile in materiale composito

- Meccanismo impulsivo doppio martello



Velocità libera	4.500 giri/min
Coppia massima	1800 Nm
Pressione di utilizzo	6,2 Bar
Consumo aria medio	215 l/min
Ø interno tubo aria	10 mm
Capacità vite/dado	Cl 8.8 M27 ● 41 mm
Capacità vite/dado	Cl 12.9 M24 ● 36 mm

3/4 kg 3,5 € 765,00 1 019280007

1928DAL

avvitatore reversibile

- Meccanismo impulsivo doppio martello

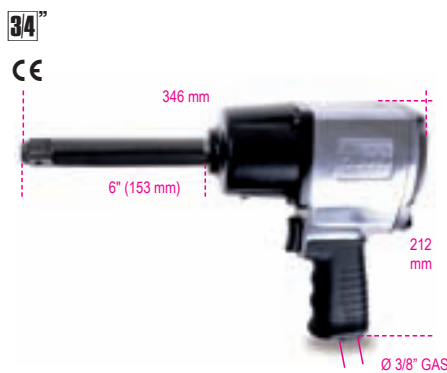

Velocità libera	5.000 giri/min
Coppia massima	1695 Nm
Pressione di utilizzo	6,2 Bar
Consumo aria medio	240 l/min
Ø interno tubo aria	10 mm
Capacità vite/dado	Cl 8.8 M27 ● 41 mm
Capacità vite/dado	Cl 12.9 M24 ● 36 mm

3/4 kg 4,8 € 650,00 1 019280023

1930CD

avvitatore reversibile in materiale composito

- Meccanismo impulsivo doppio martello



Velocità libera	4.000 giri/min
Coppia massima	2445 Nm
Pressione di utilizzo	6,2 Bar
Consumo aria medio	320 l/min
Ø interno tubo aria	13 mm
Capacità vite/dado	Cl 8.8 M36 ● 55 mm
Capacità vite/dado	Cl 12.9 M30 ● 46 mm

1 kg 7,1 € 990,00 1 019300022

1928DA

avvitatore reversibile

- Meccanismo impulsivo doppio martello



Velocità libera	5.000 giri/min
Coppia massima	1695 Nm
Pressione di utilizzo	6,2 Bar
Consumo aria medio	240 l/min
Ø interno tubo aria	10 mm
Capacità vite/dado	Cl 8.8 M27 ● 41 mm
Capacità vite/dado	Cl 12.9 M24 ● 36 mm

3/4 kg 4,3 € 585,00 1 019280022

1928K4

assortimento di un avvitatore reversibile e quattro bussole a macchina serie lunga

- Meccanismo impulsivo "Pin Clutch"



Velocità libera	4.000 giri/min
Coppia massima	1493 Nm
Pressione di utilizzo	6,2 Bar
Consumo aria medio	260 l/min
Ø interno tubo aria	10 mm
Capacità vite/dado	Cl 8.8 M27 ● 41 mm
Capacità vite/dado	Cl 12.9 M24 ● 36 mm
Peso avvitatore	5,2 Kg

3/4 kg 9,3 € 610,00 1 019280104
410x330x106 mm

1930NCD

avvitatore reversibile in materiale composito

- Meccanismo impulsivo doppio martello

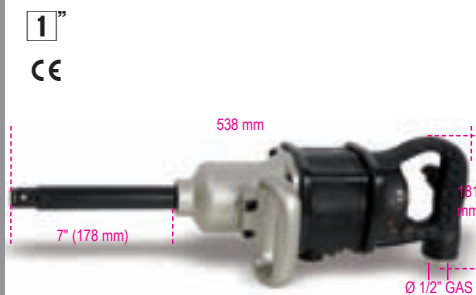

Velocità libera	4.000 giri/min
Coppia massima	2445 Nm
Pressione di utilizzo	6,2 Bar
Consumo aria medio	320 l/min
Ø interno tubo aria	13 mm
Capacità vite/dado	Cl 8.8 M36 ● 55 mm
Capacità vite/dado	Cl 12.9 M30 ● 46 mm

1 kg 8,75 € 1.030,00 1 019300027

1930PA

avvitatore reversibile

• Meccanismo impulsivo doppio martello

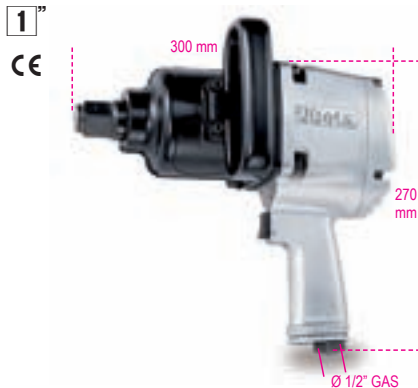

Velocità libera	3500 giri/min
Coppia massima	2445 Nm
Pressione di utilizzo	6,2 Bar
Consumo aria medio	350 l/min
Ø interno tubo aria	13 mm
Capacità vite/dado	Cl 8.8 M36 ● 55 mm
Capacità vite/dado	Cl 12.9 M30 ● 46 mm

1 kg 9,6 € 880,00 1 019300032

1930HLA

avvitatore reversibile

• Meccanismo impulsivo doppio martello



Velocità libera	3.000 giri/min
Coppia massima	3661 Nm
Pressione di utilizzo	6,2 Bar
Consumo aria medio	460 l/min
Ø interno tubo aria	13 mm
Capacità vite/dado	Cl 8.8 M42 ● 65 mm
Capacità vite/dado	Cl 12.9 M33 ● 50 mm

1 kg 16,4 € 1.280,00 1 019300040

1931CD6

trapano reversibile in composito



Capacità mandrino	1+6 mm
Filettatura albero	3/8" - 24UNF
Velocità libera	2.600 giri/min
Potenza	0,23 Kw
Pressione di utilizzo	6,2 Bar
Consumo aria medio	130 l/min
Ø interno tubo aria	8 mm

590 g € 187,00 1 019310006

1930LA

avvitatore reversibile

• Meccanismo impulsivo doppio martello

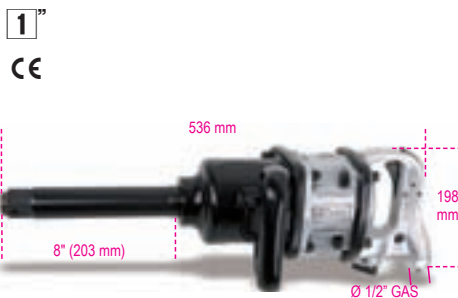

Velocità libera	4.000 giri/min
Coppia massima	2445 Nm
Pressione di utilizzo	6,2 Bar
Consumo aria medio	460 l/min
Ø interno tubo aria	13 mm
Capacità vite/dado	Cl 8.8 M36 ● 55 mm
Capacità vite/dado	Cl 12.9 M30 ● 46 mm

1 kg 10,6 € 930,00 1 019300037

1930ZL

avvitatore reversibile

• Meccanismo impulsivo doppio martello



Velocità libera	3.000 giri/min
Coppia massima	4068 Nm
Pressione di utilizzo	6,2 Bar
Consumo aria medio	480 l/min
Ø interno tubo aria	13 mm
Capacità vite/dado	Cl 8.8 M42 ● 65 mm
Capacità vite/dado	Cl 12.9 M36 ● 55 mm

1 1/2 kg 15 € 1.650,00 1 019300070

1931CD10

trapano reversibile in composito



Capacità mandrino	1+10 mm
Filettatura albero	3/8" - 24UNF
Velocità libera	1.800 giri/min
Potenza	0,38 Kw
Pressione di utilizzo	6,2 Bar
Consumo aria medio	170 l/min
Ø interno tubo aria	10 mm

1,01 kg € 167,00 1 019310010

1931CD13

trapano reversibile in composito



Capacità mandrino	1÷13 mm
Filettatura albero	1/2" - 20UNC
Velocità libera	800 giri/min
Potenza	0,38 Kw
Pressione di utilizzo	6,2 Bar
Consumo aria medio	170 l/min
Ø interno tubo aria	10 mm

kg 1,29 € 245,00 1 019310013

1932B10

trapano reversibile



Capacità mandrino	1÷10 mm
Filettatura albero	3/8" - 24UNF
Velocità libera	1.800 giri/min
Potenza	0,44 Kw
Pressione di utilizzo	6,2 Bar
Consumo aria medio	160 l/min
Ø interno tubo aria	10 mm

kg 1,15 € 135,00 1 019320040

1933

smerigliatrice assiale



Capacità pinza	3 - 6 mm
Velocità libera	25.000 giri/min
Potenza	0,20 Kw
Pressione di utilizzo	6,2 Bar
Consumo aria medio	230 l/min
Ø interno tubo aria	10 mm

g 380 € 98,00 1 019330001

1933I

smerigliatrice assiale



Capacità pinza	3 - 6 mm
Velocità libera	20.000 giri/min
Potenza	0,38 Kw
Pressione di utilizzo	6,2 Bar
Consumo aria medio	220 l/min
Ø interno tubo aria	10 mm

g 670 € 110,00 1 019330005

1931AN10

trapano angolare reversibile



Capacità mandrino	1÷10 mm
Filettatura albero	3/8" - 24UNF
Velocità libera	1.400 giri/min
Potenza	0,38 Kw
Pressione di utilizzo	6,2 Bar
Consumo aria medio	150 l/min
Ø interno tubo aria	10 mm

kg 1,05 € 187,00 1 019310030

1932RS13

trapano reversibile



Capacità mandrino	1,5÷13 mm
Filettatura albero	1/2" - 20UNC
Velocità libera	750 giri/min
Potenza	0,55 Kw
Pressione di utilizzo	6,2 Bar
Consumo aria medio	160 l/min
Ø interno tubo aria	10 mm

kg 1,4 € 175,00 1 019320043

1933L

smerigliatrice assiale con albero prolungato



Capacità pinza	3 - 6 mm
Velocità libera	25.000 giri/min
Potenza	0,20 Kw
Pressione di utilizzo	6,2 Bar
Consumo aria medio	230 l/min
Ø interno tubo aria	10 mm

g 670 € 125,00 1 019330015

1933IL

smerigliatrice assiale con albero prolungato

• Potenza elevata

CE



Capacità pinza	3 - 6 mm
Velocità libera	20.000 giri/min
Potenza	0,38 kW
Pressione di utilizzo	6,2 Bar
Consumo aria medio	230 l/min
Ø interno tubo aria	10 mm

kg 1,4 € 148,00 1 019330010

1933AN90

smerigliatrice angolare

CE



Capacità pinza	3 - 6 mm
Velocità libera	20.000 giri/min
Potenza	0,20 Kw
Pressione di utilizzo	6,2 Bar
Consumo aria medio	230 l/min
Ø interno tubo aria	10 mm

g 510 € 125,00 1 019330020

1934BV

pulitrice a basse velocità

CE



Capacità pinza	3-6 mm
Velocità libera	3.700 giri/min
Potenza	0,37 kW
Pressione di utilizzo	6,2 Bar
Consumo aria medio	113 l/min
Ø interno tubo aria	10 mm

g 840 € 130,00 1 019340000

1934MAV

microsmerigliatrice assiale

CE



Capacità pinza	3 mm
Velocità libera	56.000 giri/min
Potenza	0,04 kW
Pressione di utilizzo	6,2 Bar
Consumo aria medio	115 l/min
Ø interno tubo aria	4,5 mm

g 205 € 115,00 1 019340010

1934MAV70

microsmerigliatrice assiale ad alta velocità

CE



Capacità pinza	3 mm
Velocità libera	70.000 giri/min
Potenza	0,08 kW
Pressione di utilizzo	6,2 Bar
Consumo aria medio	115 l/min
Ø interno tubo aria	4,5 mm

g 210 € 190,00 1 019340030

1935E

giravite reversibile

1/4

CE



12 Nm

Velocità libera	1.800 giri/min
Campo di coppia	12 Nm
Pressione di utilizzo	6,2 Bar
Consumo aria medio	150 l/min
Ø interno tubo aria	10 mm
Capacità vite	6-9 M
Porta inserti	● 1/4"

kg 1,15 € 205,00 1 019350040

1935F

giravite reversibile

1/4

CE



16 Nm

Velocità libera	800 giri/min
Campo di coppia	16 Nm
Pressione di utilizzo	6,2 Bar
Consumo aria medio	150 l/min
Ø interno tubo aria	10 mm
Capacità vite	6-9 M
Porta inserti	● 1/4"

kg 1,3 € 185,00 1 019350045

1936/5A

smerigliatrice angolare

CE



Dimensione mola	125 mm
Filettatura albero	M14
Velocità libera	10.000 giri/min
Potenza	0,66 kW
Pressione di utilizzo	6,2 Bar
Consumo aria medio	390 l/min
Ø interno tubo aria	10 mm

kg 1,87 € 310,00 1 019360025

1936/5

smerigliatrice angolare

CE



Dimensione mola	125 mm
Filettatura albero	M14
Velocità libera	10500 giri/min
Potenza	0,7 Kw
Pressione di utilizzo	6,2 Bar
Consumo aria medio	380 l/min
Ø interno tubo aria	10 mm

kg 1,98 € 470,00 1 019360005

1936/7

smerigliatrice angolare

CE



Dimensione mola	178 mm
Filettatura albero	M14
Velocità libera	7000 giri/min
Potenza	1,4 Kw
Pressione di utilizzo	6,2 Bar
Consumo aria medio	500 l/min
Ø interno tubo aria	13 mm

kg 3,4 € 650,00 1 019360007

1937

levigatrice rotorbitale palmare senza lubrificazione, in composito

• Diametro orbita 5 mm

CE



Dimensione plattello	150 mm
Diametro orbita	5 mm
Velocità libera	12.000 giri/min
Filettatura albero	5/16"-24
Pressione di utilizzo	6,2 Bar
Consumo aria medio	170 l/min
Ø interno tubo aria	10 mm

g 860 € 345,00 1 019370001

1937R/P

plattello Ø 150 mm 6 fori per 1937



1937R/P € 35,00 1 019370002

1937M

levigatrice multifunzione con 16 accessori

CE



Velocità libera	3.500 giri/min
Pressione di utilizzo	6,2 Bar
Consumo aria medio	113 l/min
Ø interno tubo aria	10 mm
Peso levigatrice	1,5 kg

kg 4,5 € 530,00 1 019370011
458x415x116 mm

1937M-01÷11

accessori per 1937M



L	mm	1937M-	€	1	019370101
	30	1937M-01	19,80	1	019370102
	30	1937M-02	19,80	1	019370103
	11	1937M-03	16,50	1	019370104
	23	1937M-04	16,50	1	019370105
	11	1937M-05	16,50	1	019370106
	23	1937M-06	16,50	1	019370107
*	16	1937M-07	49,00	1	019370108
	13	1937M-08	16,50	1	019370109
	26	1937M-09	16,50	1	019370110
	23	1937M-10	16,50	1	019370111
	11	1937M-11	16,50	1	019370111

* I prezzi indicati sono relativi a 6 pezzi

Beta

Beta

1937N10

levigatrice a nastro



Dimensioni nastro 10x330 mm
Velocità libera 20.000 giri/min
Pressione di utilizzo 6,2 Bar
Consumo aria medio 374 l/min
Ø interno tubo aria 10 mm

kg 0,85 **€** 210,00 **1** 019370041

1937N10-GR

nastri abrasivi per 1937N10



	P	€	1	
1937N10-GR60	60	22,00	1	019370146
1937N10-GR80	80	22,00	1	019370148
1937N10-GR100	100	22,00	1	019370150
1937N10-GR120	120	22,00	1	019370152

I prezzi indicati sono relativi a 10 pezzi

1937N20

levigatrice a nastro



Dimensioni nastro 20x520 mm
Velocità libera 16.000 giri/min
Pressione di utilizzo 6,2 Bar
Consumo aria medio 400 l/min
Ø interno tubo aria 10 mm

kg 1,6 **€** 250,00 **1** 019370051

1937N20-GR

nastri abrasivi per 1937N20



	P	€	1	
1937N20-GR60	60	28,00	1	019370156
1937N20-GR80	80	28,00	1	019370158
1937N20-GR100	100	28,00	1	019370160
1937N20-GR120	120	28,00	1	019370162

I prezzi indicati sono relativi a 10 pezzi

1938

staccavetri

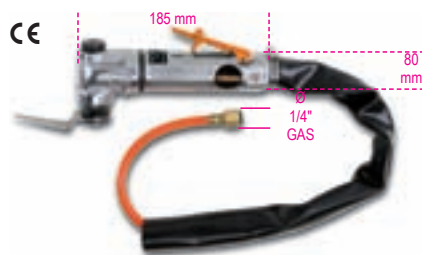

Oscillazioni al minuto 20.000
Pressione di utilizzo 6,2 Bar
Consumo aria medio 200 l/min
Ø interno tubo aria 6,5 mm

kg 1 **€** 168,00 **1** 019380021

1938R/L

lame per staccavetri

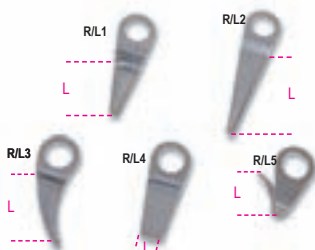

	L mm	€	1	
1938R/L1	57	14,00	1	019380041
1938R/L2	90	28,00	1	019380042
1938R/L3	50	16,00	1	019380043
1938R/L4	16	24,00	1	019380044
1938R/L5	36	28,00	1	019380045

1938R/S5

serie di 5 lame per staccavetri 1938

1938R/S5 **€** 110,00 **1** 019380055

1940

martello scalpellatore



Dimensione attacco Ø 11 mm
Dimensione pistone 19 mm
Corsa del pistone 67 mm
Colpi al minuto 3500
Pressione di utilizzo 6,2 Bar
Consumo aria medio 240 l/min
Ø interno tubo aria 8 mm

kg 1,92 **€** 138,00 **1** 019400001

1940MT

molla di tenuta per 1940



1940MT **€** 9,00 **5** 019400110

1940HD

martello scalpellatore



Dimensione attacco Ø 11 mm
Dimensione pistone 19 mm
Corsa del pistone 69 mm
Colpi al minuto 3000
Pressione di utilizzo 6,2 Bar
Consumo aria medio 280 l/min
Ø interno tubo aria 8 mm

kg 1,86 **€** 210,00 **1** 019400002

1940MT/HD

molla di tenuta per 1940HD



1940MT/HD **€** 9,00 **5** 019400111

1940S...

scalpelli per martelli scalpellatori 1940 e 1940HD



	€	5	
1940SN	10,00	5	019400020
1940ST	10,00	5	019400021
1940SD	10,00	5	019400022
1940SPS	10,00	5	019400023
1940SDT	10,00	5	019400024

1940/S5

serie di 5 scalpelli
per martelli scalpellatori 1940 e 1940HD



1940/S5 € 45,50 1 019400030

1942

seghetto alternativo

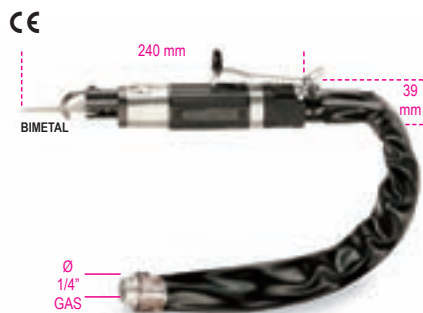

Corse al minuto 5000
Lunghezza della corsa 10 mm
Pressione di utilizzo 6,2 Bar
Consumo aria medio 200 l/min
Ø interno tubo aria 6 mm

kg 1,05 € 396,00 1 019420001

1942S

seghetto alternativo silenzioso

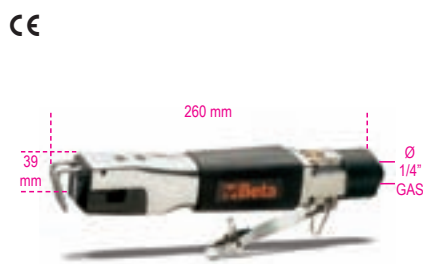

Corse al minuto 9000
Lunghezza della corsa 10 mm
Pressione di utilizzo 6,2 Bar
Consumo aria medio 210 l/min
Ø interno tubo aria 8 mm

g 700 € 250,00 1 019420002

1942LR

lame Bimetal
per seghetto alternativo 1942S



1942LR € 5,50 5 019420032

1944

scrostatore ad aghi assiale



N aghi 19
Ø aghi 3 mm
Corsa del pistone 33 mm
Colpi al minuto 3000
Pressione di utilizzo 6,2 Bar
Consumo aria medio 140 l/min
Ø interno tubo aria 8 mm

kg 2,63 € 350,00 1 019440001

1944AR

set di 19 aghi
per raschietto 1944



1944AR € 26,00 1 019440005

1944L

scrostatore ad aghi diritto



N aghi 28
Ø aghi 3 mm
Corsa del pistone 33 mm
Colpi al minuto 2800
Pressione di utilizzo 6,2 Bar
Consumo aria medio 250 l/min
Ø interno tubo aria 8 mm

kg 5,4 € 450,00 1 019440021

1944L/RA

set di 28 aghi
per raschietto 1944L



1944L/RA € 38,00 1 019440025

1946

rivettatrice

• fornita con ugelli intercambiabili
da 2,4 - 3,2 - 4,0 - 4,8 mm



Potenza di trazione 8000 N
Lunghezza della corsa 14 mm
Pressione di utilizzo 6,2 Bar
Consumo aria 1,2 l/ciclo
Ø interno tubo aria 6 mm
Capacità massima rivetti Ø alluminio 4,8 mm

kg 1,51 € 190,00 1 019460001

1946C4,8

rivettatrice

• Con aspirazione automatica
• Fornita assemblata per rivetti in acciaio, acciaio inox,



Potenza di trazione 8900 N
Lunghezza della corsa 15 mm
Pressione di utilizzo 6,2 Bar
Consumo aria 113 l/min
Ø interno tubo aria 10 mm
Capacità massima rivetti Ø acciaio inox 4,8 mm

kg 1,48 € 450,00 1 019460006

1946C7,8

rivettatrice

- Con aspirazione automatica
- Fornita assemblata per rivetti in acciaio, acciaio inox,



Potenza di trazione	16900 N
Lunghezza della corsa	22,5 mm
Pressione di utilizzo	6,2 Bar
Consumo aria	113 l/min
Ø interno tubo aria	10 mm
Capacità massima rivetti	Ø acciaio inox 7,8 mm

kg	€	1	019460008
1,8	710,00		

1947

pistola per sigillanti



Dimensione del tubo	50x210 mm
Capacità della cartuccia	350 ml
Pressione di utilizzo	6,2 Bar
Consumo aria medio	120 l/min
Ø interno tubo aria	10 mm

kg	€	1	019470001
1,1	45,00		

1948

penna per incisioni



Pressione di utilizzo	6,2 Bar
Consumo aria medio	50 l/min

g	€	1	019480001
150	230,00		

1948PR

punta in carburo di tungsteno di ricambio per 1948



g	€	1	019480005
1948PR	125,00		

1949BC

pistola di soffiaggio progressiva con ugello in gomma

- Corpo in materiale composito ad alta resistenza, antiurto
- Ugello in gomma antigraffio sostituibile
- Inserto in alluminio filettato: 1/4" GAS femmina
- Pressione d'esercizio: 6-8 Bar
- Pressione massima d'esercizio: 15 Bar
- Consumo aria medio: 87 l/min
- Temperatura d'utilizzo: -20°C ÷ 70°C



g	€	1	019490022
1949 BC	113	12,50	

1949BC/RU

ugello in gomma per 1949BC



g	€	5	019490122
1949BC/RU	15,90		

1949T

pistola di soffiaggio progressiva telescopica

- Corpo in materiale composito ad alta resistenza, antiurto
- Tubo telescopico in acciaio orientabile: 165 mm ÷ 300 mm
- Inserto in alluminio filettato: 1/4" GAS femmina
- Pressione d'esercizio: 6÷8 Bar
- Pressione massima d'esercizio: 15 Bar
- Consumo aria medio: 144 l/min
- Temperatura d'utilizzo: -20°C ÷ 70°C



g	€	1	019490040
1949T	158	21,00	

1949F

pistola di soffiaggio progressiva

- La speciale valvola e la sensibilità della leva consentono la progressiva apertura del circuito, ottimizzando il flusso dell'aria
- Inserto in ottone filettato 1/4" GAS femmina
- Pressione massima d'esercizio 10 Bar
- Temperatura d'utilizzo: -15°C ÷ 70°C.



g	€	5	019490027
1949F	133	11,00	

1949G

pistola di soffiaggio progressiva con regolatore d'aria

- La speciale valvola e la sensibilità della leva consentono la progressiva apertura del circuito, ottimizzando il flusso dell'aria
- Inserto in ottone filettato 1/4" GAS femmina
- Pressione massima d'esercizio 10 Bar
- Temperatura d'utilizzo: -15°C ÷ 70°C.



g	€	5	019490035
1949G	145	12,00	

Beta

1949DGT

pistola digitale per gonfiaggio pneumatici

- pressione di esercizio: 0÷11 bar (2,0÷160 psi)
- 4 unità di misura: psi/bar/kgcm2/kpa
- display LCD retroilluminato
- funzione reset
- autospegnimento dopo 3 min.
- pulsante di scarico pressione
- lunghezza tubo: 53 cm
- risoluzione: 0,05 bar
- corpo in abs, guscio protettivo in gomma sul manometro, impugnatura antiurto e antiscivolo
- alimentazione: 2 batterie 1,5V tipo AAA



1949DGT bar 0-11 € 117,00 1 019490020

1949GP

pistola per gonfiaggio pneumatici corpo in ABS



1949GP € 185,00 1 019490010

1949GPE

pistola per gonfiaggio pneumatici

- pressione di esercizio: 0÷11 bar (10÷160 psi)
- funzione di scarico pressione
- funzione di solo misurazione della pressione
- manometro rivestito in gomma antiurto
- rotazione del tubo a 360°



1949GPE bar 0÷11 € 89,00 1 019490008

1949R/NIP

raccordo filettato 1/4" GAS per 1949GP



1949R/NIP € 11,00 1 019490113

1901BM/8

avvolgitubo automatico corpo in materiale plastico antiurto per aria compressa o acqua fredda • Pressione di utilizzo max 12 Bar

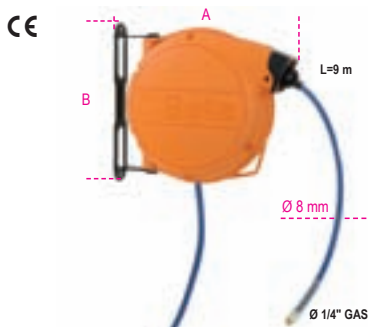

A B 310 300 € 190,00 1 019010111

1901/10

avvolgitubo automatico corpo in materiale plastico antiurto per aria compressa o acqua fredda • Pressione di utilizzo max 12 Bar



1901/10 A B 470 330 € 315,00 1 019010010

1910

avvolgitubo automatico corpo in alluminio per aria compressa o acqua fredda • Pressione di utilizzo max 12 Bar



1910 A B 400 370 € 540,00 1 019100001

1914

spirali in poliuretano 98 Shore estensibili

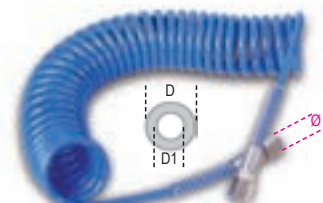

L m	D1xD mm	Ø GAS BSP	€	1
4	5x8	1/4"	18,00	019140054
6	5x8	1/4"	21,00	019140056
10	5x8	1/4"	27,00	019140060

1915B

spirali in poliuretano 95 Shore estensibili fino a 9 m

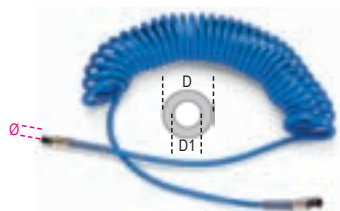

D1xD mm	Ø GAS BSP	€	1
6,5x10	1/4"	31,00	019150011
8x12	1/4"	37,00	019150012
11x16	3/8"	61,00	019150013

Beta

1915C

spirali in poliuretano 95 Shore
estensibili fino a 12 m

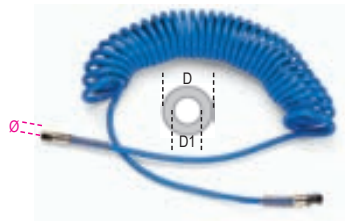

D1xD mm	Ø GAS BSP	€		
6,5x10	1/4"	37,00	1	019150014
8x12	1/4"	45,00	1	019150015
11x16	3/8"	75,00	1	019150016

1915C/L

spirali in poliuretano 95 Shore
estensibili fino a 15 m

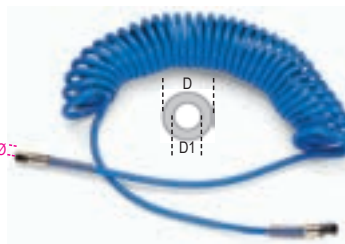

D1xD mm	Ø GAS BSP	€		
8x12	1/4"	60,00	1	019150115
11x16	3/8"	98,00	1	019150116

1915D

tubo in poliuretano retinato 95 Shore
lunghezza 9 m



D1xD mm	Ø GAS BSP	€		
8x12	1/4"	35,00	1	019150017
11x16	3/8"	58,00	1	019150018

1915E

tubo in poliuretano retinato 95 Shore
lunghezza 12 m



D1xD mm	Ø GAS BSP	€		
8x12	1/4"	45,00	1	019150019
11x16	3/8"	75,00	1	019150020

1915E/XL

bobine in poliuretano retinato 95 Shore
lunghezza 50 m



D1xD mm	Ø GAS BSP	€		
8x12	1/4"	165,00	1	019150519
11x16	3/8"	280,00	1	019150520

1916I

innesti rapidi profilo Italia
in acciaio carbonitrurato zincato
filettati maschio, GAS cilindrici BSP



Ø GAS BSP	€		
1/4"	2,20	5	019160001
3/8"	2,60	5	019160002

1916G

innesti rapidi profilo Europa
in acciaio carbonitrurato
zincato filettati maschio, GAS conici BSPT



Ø GAS BSPT	€		
1/4"	2,10	5	019160005
3/8"	3,60	5	019160010
1/2"	3,60	5	019160012

1917M

raccordi universali a sfera
con gomma antiurto
in ottone nichelato
filettati maschio GAS cilindrici BSP



Ø GAS BSP	€		
1/4"	9,00	5	019170001
3/8"	9,00	5	019170003
1/2"	10,00	5	019170004

1917F

raccordi universali a sfera con gomma
antiurto in ottone nichelato
filettati femmina GAS cilindrici BSP



Ø GAS BSP	€		
1/4"	10,00	5	019170005
3/8"	10,00	5	019170010

1917RS

raccordo universale rotante

- In alluminio anodizzato arancione filettati femmina, GAS cilindrici BSP filettati maschio, GAS conici BSPT
- Accoppiabili a tutti gli innesti con profilo Italia ed Europa



Ø GAS BSP	Ø GAS BSPT	€		
1/4"	1/4"	22,00	1	019170250

1919FE1/4

filtro regolatore lubrificatore



Attacchi aria entrata/uscita	1/4" GAS BSPT
Attacco manometro	1/8" GAS BSPT
Portata massima	750 l/min
Pressione massima	9,5 Bar
Pressione di utilizzo	0,5 - 8,5 Bar
Temperatura di utilizzo	5 - 60 °C
Capacità filtrante	5 micron
Capacità tazze	15 cc aria / 25 cc olio

g	€		
700	79,00	1	019190200

1919RB-FE1/4

coppia bicchieri di ricambio
per 1919FE1/4



€		
16,00	1	019190210

1919RF-FE1/4

ricambio elemento filtrante
per 1919FE1/4



€		
5,00	1	019190230

1919RM-FE1/4

manometro di ricambio
per 1919FE1/4



1919RM-FE1/4 € 8,50 1 019190220

1919F1/4

filtro regolatore lubrificatore

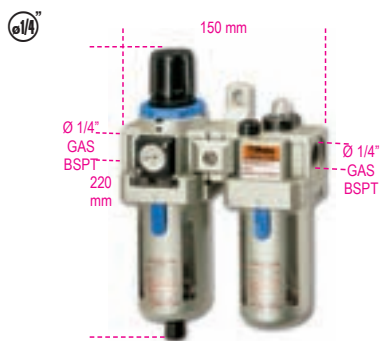

Attacchi aria entrata/uscita 1/4" GAS BSPT
Portata massima 1000 l/min
Pressione massima 9,5 Bar
Pressione di utilizzo 0,5 - 8,5 Bar
Temperatura di utilizzo 5 - 60 °C
Capacità filtrante 5 micron
Capacità tazze 60 cc aria / 90 cc olio

kg 1,3 € 125,00 1 019190250

1919F3/8

filtro regolatore lubrificatore

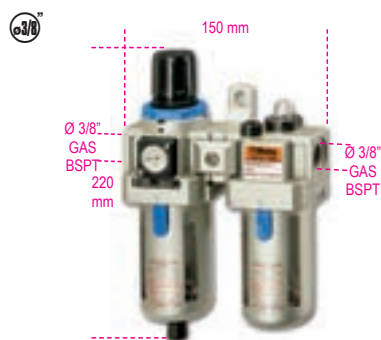

Attacchi aria entrata/uscita 3/8" GAS BSPT
Portata massima 1350 l/min
Pressione massima 9,5 Bar
Pressione di utilizzo 0,5 - 8,5 Bar
Temperatura di utilizzo 5 - 60 °C
Capacità filtrante 5 micron
Capacità tazze 60 cc aria / 90 cc olio

kg 1,3 € 125,00 1 019190350

1919F1/2

filtro regolatore lubrificatore



Attacchi aria entrata/uscita 1/2" GAS BSPT
Portata massima 2500 l/min
Pressione massima 9,5 Bar
Pressione di utilizzo 0,5 - 8,5 Bar
Temperatura di utilizzo 5 - 60 °C
Capacità filtrante 5 micron
Capacità tazze 60 cc aria / 90 cc olio

kg 1,3 € 125,00 1 019190450

1919RB-F

coppia bicchieri
per filtri 1919F - 1/4", 3/8" e 1/2"



1919RB-F € 22,00 1 019190510

1919RF-F

ricambio elemento filtrante
per filtri 1919F - 1/4", 3/8" e 1/2"



1919RF-F € 6,50 1 019190530

1919RM-F

manometro di ricambio
per filtri 1919F - 1/4", 3/8" e 1/2"



1919RM-F € 11,50 1 019190520

1919ML

mini lubrificatori di linea



Ø 1/4" € 17,00 1 019190030
3/8" € 18,00 1 019190032

1919SC

mini separatore di condensa



Ø 1/4" € 20,00 1 019190035

1919L

olio lubrificatore ISO 32

Densità a 20°C 875 kg/m³
Viscosità a 40°C 32 cSt
Infiammabilità COC 210°C



cc 500 € 13,50 5 019190050



CONTENITORI E ASSORTIMENTI



Aluminium^{AL}
Innovation
Technology

 **Beta**
www.beta-tools.com

2001/B26

busta in tessuto con assortimento di 26 utensili



2001/B26 € 158,00 1 020010050

- 55 6x7 - 8x9 - 10x11 - 12x13 - 14x15 - 16x17 mm
- 96N/SC9 1,5 - 2 - 2,5 - 3 - 4 - 5 - 6 - 8 - 10 mm
- 1044F 250 mm
- 1128BMX 145 mm
- 1150 180 mm
- 1201 3x75 - 4x100 - 5,5x150 mm
- 1202 PH1x80 - PH2x100 mm
- 1370 300 g
- 1692 2 m
- 1770A 9 mm

2001/BV26 € 32,00 1 020010051

2005PA/D

porta attrezzi vuoto in Nylon, con cintura



2005PA/D € 43,00 1 020050000

2005PA/S

porta attrezzi vuoto in Nylon, con cintura



2005PA/S € 22,00 1 020050020

2009N/BV

borsa per manutentori vuota in cuoio



530x190x210 mm € 182,00 1 020090200

2009ID

borsa con assortimento di 35 utensili per idraulica



2009ID € 605,00 1 020090012
(2009N/BV+5980ID)

2011/BV

borsa per elettricisti vuota in materiale sintetico, fianchi in ABS, con pannello portautensili rimovibile



570x260x370 mm € 275,00 1 020110200

2011ET

borse con assortimenti di utensili per elettrotecnica



2011ET/A € 897,00 1 020110127
(2011/BV+5980ET/A)
2011ET/B € 1.191,00 1 020110129
(2011/BV+5980ET/B)

2014N/VV

borsa portautensili a tre scomparti vuota in materiale sintetico con inserti in Nylon, con pannelli estraibili



440x370x170 mm € 180,00 1 020140200

2014N/VU2

borsa con 49 utensili per manutenzioni universali



2014N/VU2 € 489,00 1 020140020
(2014N/VV+5915VU/2)

2029/VV

valigia portautensili vuota in polipropilene ad alto spessore, profilata in alluminio, con doppia parete



490x230x380 mm € 240,00 1 020290000

2029E

valigie con assortimenti di utensili per elettronica ed elettrotecnica



2029BG/MQ € 1.385,00 1 020290261
(2029/VV+5980BG/MQ)
2029ET/B € 1.156,00 1 020290221
(2029/VV+5980ET/B)
2029EL/B € 1.173,00 1 020290216
(2029/VV+5980EL/B)

2029/RT

tracolla universale per borse e valigie



2029/RT € 15,50 1 020290900

2032/VV

valigia portautensili in materiale plastico vuota



mm
450x390x170 € 210,00 1 020320010

2032E

valigie con assortimenti di utensili per elettronica ed elettrotecnica



2032ET/A € 832,00 1 020320117
(2032/VV+5980ET/A)
2032EL/A € 876,00 1 020320108
(2032/VV+5980EL/A)

2032/TV

trolley portautensili vuoto, in polipropilene ad alto spessore, con doppia parete, manico telescopico e ruote con cuscinetti a sfera



mm
430x370x200 € 298,00 1 020320110

2032/TE

trolley con assortimenti di utensili per elettronica ed elettrotecnica



2032TET/A € 920,00 1 020320227
(2032/TV+5980ET/A)
2032T EL/A € 964,00 1 020320208
(2032/TV+5980EL/A)

2033N/VV

valigia portautensili vuota, in alluminio con fianchi in ABS



mm
500x380x200 € 395,00 1 020330200

2033E

valigie con assortimenti di utensili per elettronica ed elettrotecnica



2033ET/B € 1.310,00 1 020330117
(2033N/VV+5980ET/B)
2033EL/B € 1.330,00 1 020330105
(2033N/VV+5980EL/B)

2034/VV

valigia portautensili vuota, in alluminio



mm
470x380x170 € 255,00 1 020340200

2034

valigie con assortimenti di utensili per elettrotecnica e manutenzioni universali



2034ET/A € 877,00 1 020340114
(2034/VV+5980ET/A)
2034EL/A € 921,00 1 020340107
(2034/VV+5980EL/A)
2034VU/2 € 564,00 1 020340106
(2034/VV+5915V/U2)

2036/TV

trolley portautensili vuoto, in polipropilene ad alto spessore, profilato in alluminio con doppia parete, manico telescopico e ruote con cuscinetti a sfera



mm
490x260x380 € 370,00 1 020360000

2036E

trolley con assortimenti di utensili per elettronica ed elettrotecnica



2036ET/B € 1.285,00 1 020360123
(2036/TV+5980ET/B)
2036EL/B € 1.305,00 1 020360117
(2036/TV+5980EL/B)

2041UC

valigia Utility Case con assortimento di 33 utensili



2041UC € 246,00 1 020410200

- 55 6x7 - 8x9 - 10x11 - 12x13 - 14x15 - 16x17 mm
 - 96/SC9 1,5 - 2 - 2,5 - 3 - 4 - 5 - 6 - 8 - 10 mm
 - 111 200 mm
 - 1048V 250 mm
 - 1128BMX 145 mm
 - 1150 180 mm
 - 1201 2,5x50 - 3x75 - 4x100 - 5,5x100 - 6,5x150 mm
 - 1202 PH0x60 - PH1x80 - PH2x100 mm
 - 1370 300 g
 - 1692 3m
 - 1771 170 mm
 - 1834/70 70 Lumen / 140 mm
 - 1639NS-N 25m
 - 1696 200 mm
- ≡ 535x282x87 mm - 4,5 Kg

2051N

valigia in polipropilene antiurto con assortimento di 55 utensili per nautica



2051N € 612,00 1 020510200

- 42 7 - 8 - 10 - 12 - 13 - 14 - 17 - 19 mm
 - 55AS 3/8x7/16 - 1/2x9/16 - 5/8x11/16"
 - 96/SC9 \odot 1,5+10 mm
 - 111 200 mm
 - 920A \odot 10 - 12 - 13 - 14 - 17 - 19 mm
 - 920AS \odot 7/16 - 1/2 - 9/16 - 11/16 - 7/8"
 - 920/22 255 mm - \square 1/2 - \blacksquare 1/2
 - 920/25 \square 1/2 - \blacksquare 1/2
 - 920/42 \blacksquare 1/2
 - 920/55 \blacksquare 1/2
 - 956C \square 1/2 - 16 - 20,8 mm
 - 1048 250 mm
 - 1084BM 160 mm
 - 1128BMX 145 mm
 - 1150BM 180 mm
 - 1166BM 160 mm
 - 1201 \bullet 3x75 - 4x100 - 5,5x150 - 6,5x150 mm
 - 1202 \bullet PH1x80 - PH2x100 mm
 - 1390 \emptyset 35 mm
 - 1490/2 \emptyset max 240 mm
 - 1737 145 mm
 - 1778X
 - 1995 WD40 400 ml
 - 1639NS-N 25m
- ≡ 585x393x92 mm - 9 kg

2055HB

valigia Home Bag con assortimento di 24 utensili



2055HB € 146,00 1 020550210

- 55 6x7 - 8x9 - 10x11 - 12x13 mm
 - 96N/SC9 1,5 - 2 - 2,5 - 3 - 4 - 5 - 6 - 8 - 10 mm
 - 1128BMX 145 mm
 - 1150 180 mm
 - 1048V 250 mm
 - 1201 3x75 - 4x100 - 5,5x100 mm
 - 1202 PH0x60 - PH1x80 - PH2x100 mm
 - 1370 300 g
 - 1692 3m
- ≡ 373x275x70 mm - 3 Kg

2060/VV

valigia portautensili vuota, in resina ad alto spessore a tenuta stagna, galleggiante e impermeabile con valvola di rilascio a pressione manuale



mm 490x410x210 € 370,00 1 020600101

2080/VV

valigia organizer vuota



mm 400x340x70 € 40,00 1 020800101

C5 - 2105

zaino portautensili in tessuto tecnico



C5 € 81,00 1 021050000
2105VU/0 € 376,00 1 021050120
(C5+5915VU/0)

≡ 500x400x180 mm - 2,5 Kg

C6T - 2106

zaino portautensili in tessuto tecnico, con ruote



C6T € 143,00 1 021060010
2106TVU/0 € 438,00 1 021060120
(C6T+5915VU/0)

≡ 480x370x220 mm - 4,5 kg

C8 - 2108

trolley portautensili in tessuto tecnico



C8 € 134,00 1 021080000
2108VU/1 € 497,00 1 021080021
(C8+5915VU/1)

≡ 470x370x280 mm - 4 kg

C9 - 2109

borsa portautensili in tessuto tecnico



	€		
C9	75,00	1	021090000
2109VU/1 (C9+5915VU/1)	438,00	1	021090021
2109VU/3 (C9+5915VU/3)	774,00	1	021090123

≡ 550x280x320 mm - 2,6 kg

C9/RT

tracolla per C9 e C10



	€		
C9/RT	11,00	1	021090900

C10 - 2110

cestello portautensili in tessuto tecnico con vaschetta portaminuterie



	€		
C10	98,00	1	021100000
2110VU/1 (C10+5915VU/1)	461,00	1	021100021
2110VU/3 (C10+5915VU/3)	797,00	1	021100023
2110VU/AS (C10+5915VU/AS)	821,00	1	021100025

≡ 520x220x250 mm - 3,3 kg

C10S - 2110S

cestello portautensili in tessuto tecnico con vaschetta portaminuterie



	€		
C10S	76,00	1	021100001
2110SVU/1 (C10S+5915VU/1)	439,00	1	021100101
2110SVU/3 (C10S+5915VU/3)	775,00	1	021100103

≡ 420x220x250 mm - 2,3 kg

C11 - 2111

cestello portautensili in tessuto tecnico



	€		
C11	58,00	1	021110000
2111VU/1 (C11+5915VU/1)	421,00	1	021110101
2111VU/3 (C11+5915VU/3)	757,00	1	021110103

≡ 400x240x220 mm - 2 kg

C13

baule portautensili con ruote, in polipropilene ad alta resistenza



	€		
C13	230,00	1	021130000

≡ 870x410x350 mm - 7,2 kg

C15 - 2115

cestello in materiale plastico con contenitore asportabile



	€		
C15	31,00	1	021150001
2115VU/1 (C15+5915VU/1)	394,00	1	021150031
2115VU/3 (C15+5915VU/3)	730,00	1	021150033

≡ 480x260x260 mm - 2 kg

C15L - 2115L

cestello modello lungo in materiale plastico con contenitore asportabile



	€		
C15L	39,00	1	021150002
2115LVU/1 (C15L+5915VU/1)	402,00	1	021150131
2115LVU/3 (C15L+5915VU/3)	738,00	1	021150133

≡ 560x270x270 mm - 2,3 kg

C16 - 2116

Cestello in materiale plastico con vano portaoggetti interno



	€		
C16	73,00	1	021160000
2116VU/1 (C16+5915VU/1)	436,00	1	021160101
2116VU/3 (C16+5915VU/3)	772,00	1	021160103

≡ 500x260x260 mm - 2,5 kg

Beta



Beta WORK

FREE TIME

CP17 - CP17L - 2117

cestello in acciaio inox e materiale plastico con contenitore asportabile



CP17
≡ 500x200x220 mm



CP17L
≡ 575x245x265 mm

	€		
CP17	58,00	1	021170500
2117PVU/1 (CP17+5915VU/1)	421,00	1	021170041
2117PVU/3 (CP17+5915VU/3)	757,00	1	021170043
CP17L	83,00	1	021170502
2117PLVU/1 (CP17L+5915VU/1)	446,00	1	021170141
2117PLVU/3 (CP17L+5915VU/3)	782,00	1	021170143
CP17:	2,5 kg		
CP17L:	3,7 kg		

C18 - 2118

cestello semplice in lamiera



	€		
C18	30,00	1	021180001
2118VU/1 (C18+5915VU/1)	393,00	1	021180031
≡ 450x200x100 mm - 3 kg			

C19 - 2119 - C19L - 2119L

cestello estendibile a tre scomparti in lamiera



C19
≡ 450x200x160 mm



C19L
≡ 550x200x160 mm

	€		
C19	39,00	1	021190001
C19L	49,00	1	021190002
2119VU/3 (C19+5915VU/3)	738,00	1	021190023
2119LVU/3 (C19L+5915VU/3)	748,00	1	021190123
C19:	3,4 kg		
C19L:	4 kg		

C20 - C20L - 2120

cestello estendibile a cinque scomparti in lamiera



C20
≡ 450x200x210 mm



C20L
≡ 550x200x210 mm

	€		
C20	54,00	1	021200001
2120VU/2 (C20+5915VU/2)	363,00	1	021200016
2120VU/3 (C20+5915VU/3)	753,00	1	021200017
2120VU/4 (C20+5915VU/4)	940,00	1	021200018
2120VU/AS (C20+5915VU/AS)	777,00	1	021200019
C20L	59,00	1	021200002
2120LVU/2 (C20L+5915VU/2)	368,00	1	021200016
2120LVU/3 (C20L+5915VU/3)	758,00	1	021200017
2120LVU/4 (C20L+5915VU/4)	945,00	1	021200018
2120LVU/AS (C20L+5915VU/AS)	782,00	1	021200019
C20:	4,3 kg		
C20L:	5,4 kg		

C22B

baule portautensili in lamiera



C22B O
≡ 720x320x310 mm



C22BM O
≡ 850x360x350 mm



C22BL O
≡ 1010x410x400 mm

	€		
C22B O	150,00	1	022000150
C22BM O	170,00	1	022000160
C22BL O	220,00	1	022000170

C22B O: 13 kg
C22BM O: 20 kg
C22BL O: 26 kg

C22W

baule portautensili in lamiera, rivestito internamente per una maggiore protezione degli utensili



C22W O
≡ 690x300x360 mm



C22WL O
≡ 990x300x360 mm

	€		
C22W O	160,00	1	022000269
C22WL O	230,00	1	022000299

C22W O: 15 kg
C22WL O: 28 kg



C22S - 2200S

cassettera portatile
con tre cassetti

Caratteristiche principali:

- Tre cassetti da 588x277 mm, montati su guide telescopiche a sfera:
- 1 cassetto altezza 50 mm
- 2 cassetti altezza 70 mm.
- Serratura centralizzata frontale.
- Maniglie laterali a scomparsa per il trasporto.

19 kg

	€			
C22S O	325,00	1	022000501	
2200S-OVU1T (C22S-O+5923VU/1T)	1.086,00	1	022000451	267
2200S-OVI (C22S-O+5902VI)	1.530,00	1	022000421	249
2200S-OMT (C22S-O+5902MT)	1.935,00	1	022000431	277
2200S-OMTAS (C22S-O+5902MT/AS)	1.985,00	1	022000441	278
C22S G	325,00	1	022000502	
2200S-GVU1T (C22S-G+5923VU/1T)	1.086,00	1	022000452	267
2200S-GVI (C22S-G+5902VI)	1.530,00	1	022000422	249
2200S-GMT (C22S-G+5902MT)	1.935,00	1	022000432	277
2200S-GMTAS (C22S-G+5902MT/AS)	1.985,00	1	022000442	278
C22S R	325,00	1	022000503	
2200S-RVU1T (C22S-R+5923VU/1T)	1.086,00	1	022000453	267
2200S-RVI (C22S-R+5902VI)	1.530,00	1	022000423	249
2200S-RMT (C22S-R+5902MT)	1.935,00	1	022000433	277
2200S-RMTAS (C22S-R+5902MT/AS)	1.985,00	1	022000443	278



C22S O



C22S G



C22S R

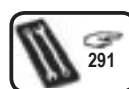

h	max
50 mm	25 kg
70 mm	25 kg

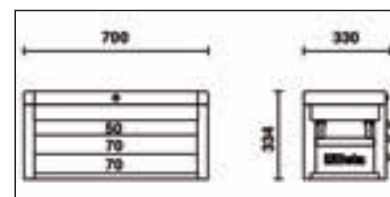
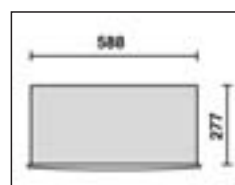

C23S - 2300S

cassettera portatile
con cinque cassetti

Caratteristiche principali:

- Cinque cassetti da 588x277 mm, montati su guide telescopiche a sfera:
- 2 cassetti altezza 50 mm
- 3 cassetti altezza 70 mm.
- Serratura centralizzata frontale.
- Maniglie laterali a scomparsa per il trasporto.

26 kg

	€			
C23S O	400,00	1	023000501	
2300S-OVU1T (C23S-O+5923VU/1T)	1.161,00	1	023000441	267
2300S-OVI (C23S-O+5902VI)	1.605,00	1	023000451	249
2300S-OMT (C23S-O+5902MT)	2.010,00	1	023000461	277
2300S-OMT/AS (C23S-O+5902MT/AS)	2.060,00	1	023000471	278
C23S G	400,00	1	023000502	
2300S-GVU1T (C23S-G+5923VU/1T)	1.161,00	1	023000442	267
2300S-GVI (C23S-G+5902VI)	1.605,00	1	023000452	249
2300S-GMT (C23S-G+5902MT)	2.010,00	1	023000462	277
2300S-GMTAS (C23S-G+5902MT/AS)	2.060,00	1	023000472	278
C23S R	400,00	1	023000503	
2300S-RVU1T (C23S-R+5923VU/1T)	1.161,00	1	023000443	267
2300S-RVI (C23S-R+5902VI)	1.605,00	1	023000453	249
2300S-RMT (C23S-R+5902MT)	2.010,00	1	023000463	277
2300S-RMTAS (C23S-R+5902MT/AS)	2.060,00	1	023000473	278



C23S O



C23S G



C23S R



h	max
50 mm	25 kg
70 mm	25 kg

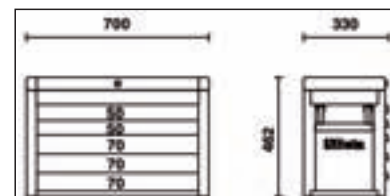
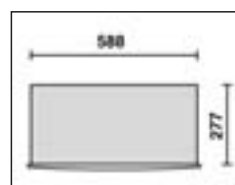

C23SC - 2300SC

cassetiera portatile
con otto cassetti

Caratteristiche principali:

- Otto cassetti montati su guide telescopiche a sfera:
- 4 cassetti altezza 50 mm
- 3 cassetti altezza 70 mm
- 1 cassetto altezza 100 mm.
- Serratura centralizzata frontale.
- Maniglie laterali a scomparsa per il trasporto.

📦 28 kg

	€	📦	🖨️	🔗
C23SC O	445,00	1	023000511	
2300SC-O/VU1T (C23SC O+5923VU/1T)	1.205,00	1	023000611	267
2300SC-O/VI (C23SC O+5902VI)	1.650,00	1	023000481	249
2300SC-O/MT (C23SC O+5902MT)	2.055,00	1	023000491	277
C23SC G	445,00	1	023000512	
2300SC-G/VU1T (C23SC G+5923VU/1T)	1.205,00	1	023000612	267
2300SC-G/VI (C23SC G+5902VI)	1.650,00	1	023000482	249
2300SC-G/MT (C23SC G+5902MT)	2.055,00	1	023000492	277
C23SC R	445,00	1	023000513	
2300SC-R/VU1T (C23SC R+5923VU/1T)	1.205,00	1	023000613	267
2300SC-R/VI (C23SC R+5902VI)	1.650,00	1	023000483	249
2300SC-R/MT (C23SC R+5902MT)	2.055,00	1	023000493	277



C23SC O



C23SC G



C23SC R



291

h	max
50 mm	25 kg
70 mm	25 kg

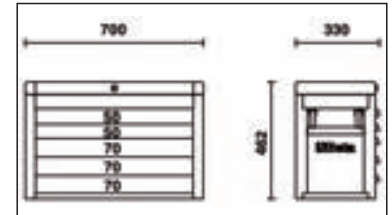
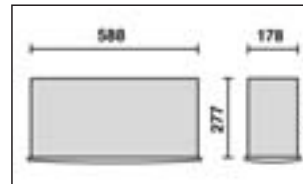

C23ST - 2300ST

cassetiera portatile
con cinque cassetti

Caratteristiche principali:

- Cinque cassetti da 588x367 mm, montati su guide telescopiche a sfera:
- 5 cassetti altezza 70 mm
- Serratura centralizzata frontale.
- Capacità di carico del singolo cassetto 15 kg
- Possibilità di applicazione del kit 4 ruote più maniglione (2300ST/KIT)

📦 29 kg

	€	📦	🖨️	🔗
C23ST O	470,00	1	023000521	
2300ST-O/VI1T (C23ST O+5904VI/1T)	1.590,00	1	023000671	250
2300ST-O/VG1M (C23ST O+5904VG/1M)	1.405,00	1	023000685	279
C23ST G	470,00	1	023000522	
2300ST-G/VI1T (C23ST G+5904VI/1T)	1.590,00	1	023000672	250
2300ST-G/VG1M (C23ST G+5904VG/1M)	1.405,00	1	023000686	279
C23ST R	470,00	1	023000523	
2300ST-R/VI1T (C23ST R+5904VI/1T)	1.590,00	1	023000673	250
2300ST-R/VG1M (C23ST R+5904VG/1M)	1.405,00	1	023000687	279



C23ST O



C23ST G



C23ST R

h	max
70 mm	25 kg



291

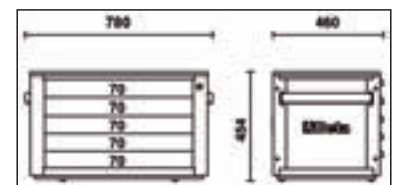

2300ST/KIT

kit con quattro ruote e maniglione per C23ST

- Quattro ruote Ø 125 mm:
2 fisse e 2 girevoli (una con freno).
- Maniglione telescopico

📦 6,5 kg

2300ST/KIT

€ 135,50 1 023000950



CD23S

carrello Caddy

Caratteristiche principali:

- Piano di lavoro ricoperto in ABS
sul quale sono collocabili a misura le cassettiere
C22S, C23S, C23SC.
- Timone di guida smontabile, collocabile sotto il piano.
- Quattro ruote Ø 100 mm:
2 fisse e 2 girevoli (una con freno).
- Portata massima 250 kg.

📦 14 kg

CD23S

€ 168,00 1 023000610



 **Beta**



C24S/5 - 2400S5

cassettiera mobile con cinque cassetti

Caratteristiche principali:

- Cinque cassetti da 588x367 mm, montati su guide telescopiche a sfera:
- 2 cassetti altezza 70 mm
- 2 cassetti altezza 140 mm
- 1 cassetto altezza 280 mm
- Piano dei cassetti protetto da tappetini di gomma espansa.
- Quattro ruote Ø 125 mm: 2 fisse e 2 girevoli (una con freno).
- Serratura di sicurezza centralizzata frontale.
- Capacità di carico statico: 800 kg.
- Piano di lavoro termoplastico sul quale è collocabile a misura una cassettera C22S, C23S, C23SC e C23ST
- Portaflacone laterale integrato.
- Possibilità di applicazione del portacarta 2400S-R/PC.

📦 52 kg



h	max
70 mm	25 kg
140 mm	30 kg
280 mm	35 kg

	€	📦	🚚	🔧
C24S O/5	565,00	1	024002051	
2400S5-O/VI1T (C24S5/O+5904VI/1T)	1.685,00	1	024002504	250
2400S5-O/VG2T (C24S5/O+5904VG/2T)	1.630,00	1	024002514	280
2400S5-O/VU1M (C24S5/ O+5904VU/1M)	1.505,00	1	024002517	258
C24S G/5	565,00	1	024002052	
2400S5-G/VI1T (C24S5/G+5904VI/1T)	1.685,00	1	024002505	250
2400S5-G/VG2T (C24S5/G+5904VG/2T)	1.630,00	1	024002515	280
2400S5-G/VU1M (C24S5/G+5904VU/1M)	1.505,00	1	024002518	258
C24S R/5	565,00	1	024002053	
2400S5-R/VI1T (C24S5/R+5904VI/1T)	1.685,00	1	024002506	250
2400S5-R/VG2T (C24S5/R+5904VG/2T)	1.630,00	1	024002516	280
5400S5-R/VU1M (C24S5/R+5904VU/1M)	1.505,00	1	024002519	258

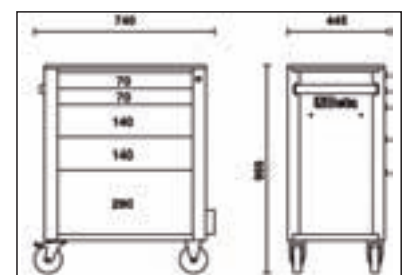
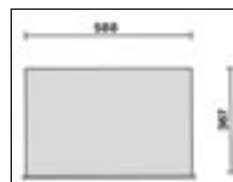

C24S/6 - 2400S6

cassettiera mobile con sei cassetti

Caratteristiche principali:

- Sei cassetti da 588x367 mm, montati su guide telescopiche a sfera:
- 4 cassetti altezza 70 mm
- 1 cassetto altezza 140 mm
- 1 cassetto altezza 280 mm
- Piano dei cassetti protetto da tappetini di gomma espansa.
- Quattro ruote Ø 125 mm:
- 2 fisse e 2 girevoli (una con freno).
- Serratura di sicurezza centralizzata frontale.
- Capacità di carico statico: 800 kg.
- Piano di lavoro termoplastico sul quale è collocabile a misura una cassetteria C22S, C23S, C23SC e C23ST
- Portaflacone laterale integrato.
- Possibilità di applicazione del portacarta 2400S-R/PC.

55 kg

800 kg



C24S O/6



C24S G/6



C24S R/6

h	max
70 mm	25 kg
140 mm	30 kg
280 mm	35 kg

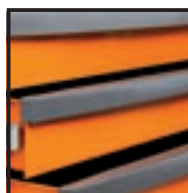

	€			
C24S O/6	630,00	1	024002061	
2400S6-O/VI1T (C24S6/O+5904VI/1T)	1.750,00	1	024002614	250
2400S6-O/VU1M (C24S6/O+5904VU/1M)	1.570,00	1	024002617	258
2400S6-O/VG2T (C24S6/O+5904VG/2T)	1.695,00	1	024002624	280
C24S G/6	630,00	1	024002062	
2400S6-G/VI1T (C24S6/G+5904VI/1T)	1.750,00	1	024002615	250
2400S6-G/VU1M (C24S6/G+5904VU/1M)	1.570,00	1	024002618	258
2400S6-G/VG2T (C24S6/G+5904VG/2T)	1.695,00	1	024002625	280
C24S R/6	630,00	1	024002063	
2400S6-R/VI1T (C24S6/R+5904VI/1T)	1.750,00	1	024002616	250
2400S6-R/VU1M (C24S6/R+5904VU/1M)	1.570,00	1	024002619	258
2400S6-R/VG2T (C24S6/R+5904VG/2T)	1.695,00	1	024002626	280

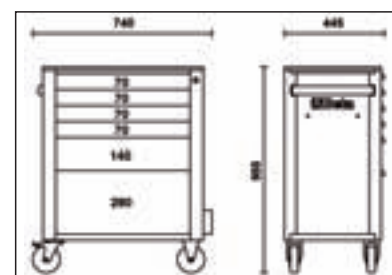
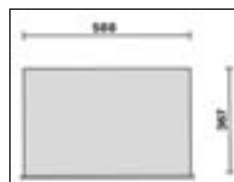

C24S/7 - 2400S7

cassettiera mobile con sette cassetti

Caratteristiche principali:

- Sette cassetti da 588x367 mm, montati su guide telescopiche a sfera:
- 5 cassetti altezza 70 mm
- 1 cassetto altezza 140 mm
- 1 cassetto altezza 210 mm
- Piano dei cassetti protetto da tappetini di gomma espansa.
- Quattro ruote Ø 125 mm: 2 fisse e 2 girevoli (una con freno).
- Serratura di sicurezza centralizzata frontale.
- Capacità di carico statico: 800 kg.
- Piano di lavoro termoplastico sul quale è collocabile a misura una cassettera C22S, C23S, C23SC e C23ST
- Portaflacone laterale integrato.
- Possibilità di applicazione del portacarta 2400S-R/PC.

📦 58 kg



C24S O/7



C24S G/7



C24S R/7

h	max
70 mm	25 kg
140 mm	30 kg
210 mm	30 kg

	€	📦	🚚	🔧
C24S O/7	690,00	1		024002071
2400S7-O/VG3 (C24S7/O+5904VG/3)	2.320,00	1		024002734 281
2400S7-O/VG1M (C24S7/O+5904VG/1M)	1.625,00	1		024002741 279
2400S7-O/VU2M (C24S7/O+5904VU/2M)	1.930,00	1		024002744 259
2400S7-O/VU3T (C24S7/O+5904VU/3T)	2.135,00	1		024002747 260
C24S G/7	690,00	1		024002072
2400S7-G/VG3 (C24S7/G+5904VG/3)	2.320,00	1		024002735 281
2400S7-GVG1M (C24S7/G+5904VG/1M)	1.625,00	1		024002742 279
2400S7-G/VU2M (C24S7/G+5904VU/2M)	1.930,00	1		024002745 259
2400S7-G/VU3T (C24S7/G+5904VU/3T)	2.135,00	1		024002748 260
C24S R/7	690,00	1		024002073
2400S7-R/VG3 (C24S7/R+5904VG/3)	2.320,00	1		024002736 281
2400S7-R/VG1M (C24S7/R+5904VG/1M)	1.625,00	1		024002743 279
2400S7-R/VU2M (C24S7/R+5904VU/2M)	1.930,00	1		024002746 259
2400S7-R/VU3T (C24S7/R+5904VU/3T)	2.135,00	1		024002749 260

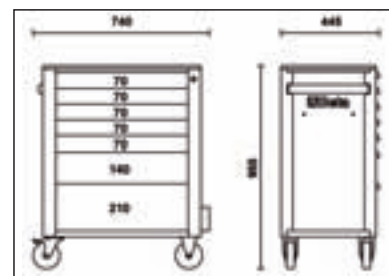

C24S/8 - 2400S8

cassetiera mobile con otto cassette

Caratteristiche principali:

- Otto cassette da 588x367 mm, montati su guide telescopiche a sfera:
- 6 cassette altezza 70 mm
- 2 cassette altezza 140 mm
- Piano dei cassetti protetto da tappetini di gomma espansa.
- Quattro ruote Ø 125 mm:
- 2 fisse e 2 girevoli (una con freno).
- Serratura di sicurezza centralizzata frontale.
- Capacità di carico statico: 800 kg.
- Piano di lavoro termoplastico sul quale è collocabile a misura una cassettera C22S, C23S, C23SC e C23ST
- Portaflacone laterale integrato.
- Possibilità di applicazione del portacarta 2400S-R/PC.

61 kg



C24S O/8



C24S G/8



C24S R/8

h	max
70 mm	25 kg
140 mm	30 kg

	€			
C24S O/8	740,00	1	024002081	
2400S8-O/VI2T (C24S8/O+5904VI/2T)	2.275,00	1	024002807	251
2400S8-O/VG3 (C24S8/O+5904VG/3)	2.370,00	1	024002814	281
2400S8-O/VI3T (C24S8/O+5904VI/3T)	2.520,00	1	024002817	252
2400S8-O/VG5T (C24S8/O+5904VG/5T)	2.440,00	1	024002824	282
C24S G/8	740,00	1	024002082	
2400S8-G/VI2T (C24S8/G+5904VI/2T)	2.275,00	1	024002808	251
2400S8-G/VG3 (C24S8/G+5904VG/3)	2.370,00	1	024002815	281
2400S8-G/VI3T (C24S8/G+5904VI/3T)	2.520,00	1	024002818	252
2400S8-G/VG5T (C24S8/G+5904VG/5T)	2.440,00	1	024002825	282
C24S R/8	740,00	1	024002083	
2400S8-R/VI2T (C24S8/R+5904VI/2T)	2.275,00	1	024002809	251
2400S8-R/VG3 (C24S8/R+5904VG/3)	2.370,00	1	024002816	281
2400S8-R/VI3T (C24S8/R+5904VI/3T)	2.520,00	1	024002819	252
2400S8-R/VG5T (C24S8/R+5904VG/5T)	2.440,00	1	024002826	282

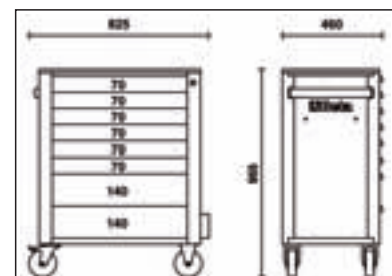
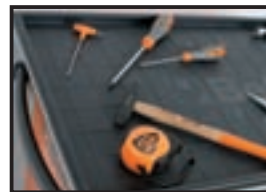
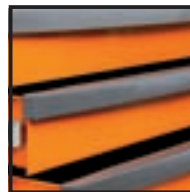

C24SA/7 - 2400SA7

cassettiera mobile con sette cassetti, con sistema antiribaltamento

Caratteristiche principali:

- Sette cassetti da 588x367 mm, montati su guide telescopiche a sfera:
- 5 cassetti altezza 70 mm
- 1 cassetto altezza 140 mm
- 1 cassetto altezza 210 mm
- Piano dei cassetti protetto da tappetini di gomma espansa.
- Quattro ruote Ø 125 mm:
- 2 fisse e 2 girevoli (una con freno).
- Serratura di sicurezza centralizzata frontale.
- Capacità di carico statico: 800 kg.
- Piano di lavoro termoplastico sul quale è collocabile a misura una cassettera C22S, C23S, C23SC e C23ST
- Portaflacone laterale integrato.
- Possibilità di applicazione del portacarta 2400S-R/PC.

58 kg



C24SA-O/7



C24SA-G/7



C24SA-R/7

h	max
70 mm	25 kg
140 mm	30 kg
210 mm	30 kg



	€			
C24SA-O/7	740,00	1	024002171	
2400SA7-O/VG3 (C24SA7/O+5904VG/3)	2.370,00	1	024002737	281
2400SA7-O/VG1M (C24SA7O+5904VG/1M)	1.675,00	1	024002754	279
2400SA7-O/VU3T (C24SA7O+5904VU/3T)	2.185,00	1	024002757	260
C24SA-G/7	740,00	1	024002172	
2400SA7-G/VG3 (C24SA7/G+5904VG/3)	2.370,00	1	024002738	281
2400SA7-G/VG1M (C24SA7G+5904VG/1M)	1.675,00	1	024002755	279
2400SA7-G/VU3T (C24SA7G+5904VU/3T)	2.185,00	1	024002758	260
C24SA-R/7	740,00	1	024002173	
2400SA7-R/VG3 (C24SA7/R+5904VG/3)	2.370,00	1	024002739	281
2400SA7-R/VG1M (C24SA7R+5904VG/1M)	1.675,00	1	024002756	279
2400SA7-R/VU3T (C24SA7R+5904VU/3T)	2.185,00	1	024002759	260

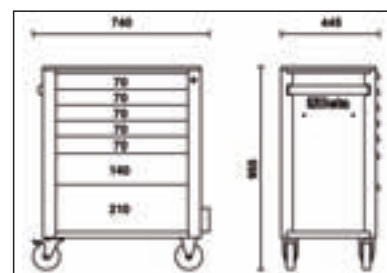

C24SA-XL/7 - 2400SAXL7

cassettiera mobile con sette cassetti,
con sistema antiribaltamento,
modello lungo

Caratteristiche principali:

- 7 cassetti da 882x367 mm, montati su guide telescopiche a sfera:
- 5 cassetti altezza 70 mm
- 1 cassetto altezza 140 mm
- 1 cassetto altezza 210 mm
- Piano di lavoro in ABS ad alta resistenza, con 6 vaschette portaminuterie.
- Frontalino in nylon ad alta resistenza, con porta-etichette integrato.
- Piano dei cassetti protetto da tappetini di gomma espansa.
- Quattro ruote Ø 125 mm: 2 fisse e 2 girevoli (una con freno).
- Serratura di sicurezza centralizzata frontale.
- Capacità di carico statico: 1.000 kg.
- Portaflaconi laterale integrato.
- Possibilità di applicazione del portacarta 2400S-R/PC.

63 kg

1000 kg



C24SA-XL 7/O



C24SA-XL 7/G



C24SA-XL 7/R

h	max
70 mm	30 kg
140 mm	35 kg
210 mm	35 kg



Model	Price (€)	Qty	Code	Weight (kg)
C24SA-XL 7/O	890,00	1	024002271	
2400SAXL-O/VI3T (C24SA-XL/7 O+5904VI3T)	2.670,00	1	024002451	252
2400SAXL-O/VG5T (C24SA-XL/7O +5904VG5T)	2.590,00	1	024002454	282
2400SAXL-O/VU2M (C24SA-XL/7 O+5904VU2M)	2.130,00	1	024002457	259
C24SA-XL 7/G	890,00	1	024002272	
2400SAXL-G/VI3T (C24SA-XL/7 G+5904VI3T)	2.670,00	1	024002452	252
2400SAXL-G/VG5T (C24SA-XL/7G +5904VG5T)	2.590,00	1	024002455	282
2400SAXL-G/VU2M (C24SA-XL/7 G+5904VU2M)	2.130,00	1	024002458	259
C24SA-XL 7/R	890,00	1	024002273	
2400SAXL-R/VI3T (C24SA-XL/7 R+5904VI3T)	2.670,00	1	024002453	252
2400SAXL-R/VG5T (C24SA-XL/7R +5904VG5T)	2.590,00	1	024002456	282
2400SAXL-R/VU2M (C24SA-XL/7 R+5904VU2M)	2.130,00	1	024002459	259

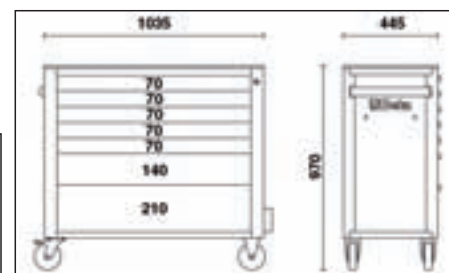
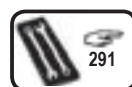

2400S-R/PC

portacarta per rotoli
preforati

• Abbinabile alle cassettiere
serie C24S

📦 0,3 kg



- 2400S R/PC-O
- 2400S R/PC-G
- 2400S R/PC-R



2400S R/PC-O	€ 15,00	📦 1	🖨️ 024002951
2400S R/PC-G	€ 15,00	📦 1	🖨️ 024002952
2400S R/PC-R	€ 15,00	📦 1	🖨️ 024002953

2400S/PF

portaflaconi

• Abbinabile alle cassettiere
serie C24S

📦 0,5 kg



2400S/PF	€ 14,50	📦 1	🖨️ 024002906
----------	---------	-----	--------------

2499PF

portaflaconi

• Abbinabile alle cassettiere serie C38, C38A
e carrello CX52.

📦 2,5 kg

- 2499PF O
- 2499PF G
- 2499PF R



2499PF O	€ 51,00	📦 1	🖨️ 024990210
2499PF G	€ 51,00	📦 1	🖨️ 024990219
2499PF R	€ 51,00	📦 1	🖨️ 024990230

 **Beta**



2499PF/M

portaflaconi universale magnetico

2,2 kg



2499PF/M € 42,00 1 024990050

2499PP/M

supporto magnetico per avvitatore pneumatico

1,5 kg



2499PP/M € 80,00 1 024990060

2499PC

portacarta per rotoli preforati

• Abbinabile a tutti i carrelli Tank C25, NewTeam CX52 e alle cassettiere serie C38 e C38A.

2,2 kg



2499PC € 48,00 1 024990090

 **Beta**

C24SL - 2400SL

cassettiera mobile
con sette cassetti
e ripiani laterali

Caratteristiche principali:

- Sette cassetti da 588x367 mm, montati su guide telescopiche a sfera:
- 5 cassetti altezza 70 mm
- 1 cassetto altezza 140 mm
- 1 cassetto altezza 210 mm.
- Piano dei cassetti protetto da tappetini di gomma espansa.
- Quattro ruote Ø 125 mm:
- 2 fisse e 2 girevoli (due con freno).
- Serratura centralizzata frontale.
- Capacità di carico statico: 1.100 kg.
- Piano di lavoro in legno multistrato con fori per la collocazione di una morsa (1599F/100 da ordinare separatamente).
- Vano laterale con ripiano regolabile in altezza.
- Portacarta integrato.
- Doppio portafaconi posteriore.

📦 63 kg

	€	📦	🖨️	🔗
C24SL O	1.000,00	1	024002101	
2400SL-O/VI2T (C24SL/O+5904VI/2T)	2.540,00	1	024002407	251
2400SL-O/VG3 (C24SL/O+5904VG/3)	2.630,00	1	024002414	281
2400SL-O/VU2M (C24SL/O+5904VU/2M)	2.240,00	1	024002417	259
C24SL G	1.000,00	1	024002102	
2400SL-G/VI2T (C24SL/G+5904VI/2T)	2.540,00	1	024002408	251
2400SL-G/VG3 (C24SL/G+5904VG/3)	2.630,00	1	024002415	281
2400SL-G/VU2M (C24SL/G+5904VU/2M)	2.240,00	1	024002418	259
C24SL R	1.000,00	1	024002103	
2400SL-R/VI2T (C24SL/R+5904VI/2T)	2.540,00	1	024002409	251
2400SL-R/VG3 (C24SL/R+5904VG/3)	2.630,00	1	024002416	281
2400SL-R/VU2M (C24SL/R+5904VU/2M)	2.240,00	1	024002419	259



C24SL O



C24SL G



C24SL R

h	max
70 mm	25 kg
140 mm	30 kg
210 mm	30 kg

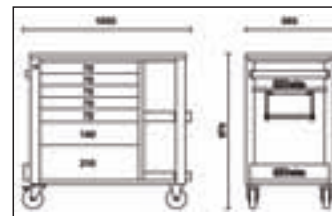
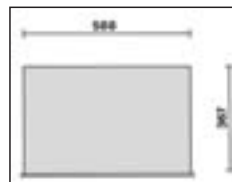

C25 - 2500

carrello Tank con mensola

Caratteristiche principali:

- Coperchio di chiusura ribaltabile.
- 1 cassetto scorrevole.
- Piano di alloggiamento utensili protetto da tappetini di gomma espansa.
- Piani di servizio protetti con tappetini in gomma antiolio e antibenzina.
- Quattro ruote Ø 100 mm:
- 2 fisse e 2 girevoli (una con freno).
- Serratura centralizzata frontale.
- Termoformato vuoto per bussole e accessori da 1/2" (024990104)
- Possibilità di applicazione del portacarta 2499PC.

📦 31,5 kg

	€	📦	🖨️	🔗
C25	570,00	1	025000001	
2500/VI1 (C25+5902VI)	1.775,00	1	025000079	249
2500/VG1 (C25+5905VG/1)	2.045,00	1	025000082	283
2500/VG2 (C25+5905VG/2)	1.995,00	1	025000084	284



C28 - 2800

carrello SuperTank con piano di lavoro e dieci cassetti

Caratteristiche principali:

- Dieci cassetti da 588x367 mm, montati su guide telescopiche a sfera.
- Sistema rapido e sicuro per l'apertura e chiusura dei cassetti con frontalino in nylon e fibra di vetro.
- Cinque cassetti laterali di cui:
 - 4 cassetti altezza 70 mm
 - 1 cassetto altezza 210 mm.
- Cinque cassetti frontali di cui:
 - 4 cassetti altezza 70 mm
 - 1 cassetto altezza 210 mm.
- Piano dei cassetti protetto da tappetini di gomma espansa.
- Quattro ruote ad alta portata Ø 150 mm: 2 fisse e 2 girevoli con freno.
- 2 serrature di sicurezza centralizzate.
- 3 cassettoni frontali portaoggetti.
- Piano di lavoro in legno multistrato con fori per la collocazione di una morsa (1599F/150 da ordinare separatamente).
- Vano integrato portaminuterie.
- Vano laterale con antina di chiusura a scomparsa con serratura.
- Portaflaconi integrati.
- Vano passante altezza 135 mm con base ricoperta in materiale plastico.
- Capacità di carico statico: kg 1200.

130 kg

1200 kg



C28 O



C28 G



C28 R



	€			
C28 O	1.830,00	1	028000301	
2800 O/VI3T (C28 O+5904VI/3T)	3.610,00	1	028000317	252
2800 O/VI2T (C28 O+5908VI/2T)	4.150,00	1	028000324	253
2800 O/VG2T (C28 O+5908VG/2T)	4.680,00	1	028000347	285
C28 G	1.830,00	1	028000302	
2800 G/VI3T (C28 G+5904VI/3T)	3.610,00	1	028000318	252
2800 G/VI2T (C28 G+5908VI/2T)	4.150,00	1	028000325	253
2800 G/VG2T (C28 G+5908VG/2T)	4.680,00	1	028000348	285
C28 R	1.830,00	1	028000303	
2800 R/VI3T (C28 R+5904VI/3T)	3.610,00	1	028000319	252
2800 R/VI2T (C28 R+5908VI/2T)	4.150,00	1	028000326	253
2800 R/VG2T (C28 R+5908VG/2T)	4.680,00	1	028000349	285

h	max
70 mm	25 kg
210 mm	30 kg

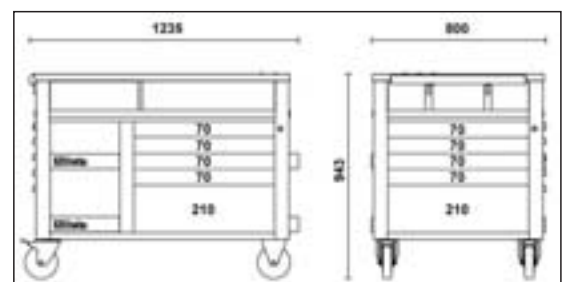

C30S - 3000S

postazione di lavoro mobile MaxiTank

Caratteristiche principali:

- 5 cassetti frontali montati su guide telescopiche a sfera:
- 3 cassetti 367x588 mm, altezza 70 mm
- 1 cassetto 610x588 mm, altezza 70 mm
- 1 cassetto 610x588 mm, altezza 140 mm
- Sistema di apertura rapido con frontalino in alluminio.
- Piano dei cassetti protetto da tappetini di gomma espansa.
- Predisposizione per l'inserimento di termoformati.
- Un martinetto idraulico consente, senza sforzo, il sollevamento della parte anteriore e quindi un trasporto agevole.
- Quattro ruote ad alta portata:
- 2 girevoli, anteriori, Ø 150 mm
- 2 fisse, posteriori, Ø 170 mm.
- Piano di lavoro ricoperto in gomma antiolio 1300x800 mm con foro di scarico per la raccolta di liquidi in un piccolo serbatoio.
- Vano passante 720x250x1300 mm con piano ricoperto in PVC, chiuso frontalmente da antine a scomparsa.
- Chiusura centralizzata per cassetti e antine.
- 3 portafiacconi laterali integrati.
- Portacarta integrato
- Capacità di carico statico: kg 1800.
- Predisposizione per la collocazione di un piano di lavoro in legno multistrato (3000 S/PLM) da ordinare separatamente
- Possibilità di collocazione di una morsa 1599F/150. (da ordinare separatamente)

1800
kg



200 kg

	€			
C30S	2.900,00	1	030000100	
3000S/VI3T (C30S+5910VI/3T)	7.010,00	1	030000093	254
3000S/VG3T (C30S+5910VG/3T)	6.950,00	1	030000097	286



h	max
70 mm	30 kg
140 mm	35 kg

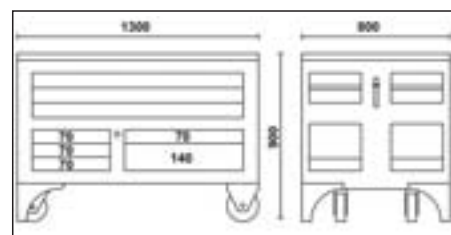

3000S/PLM

piano di lavoro in legno per C30S
con fori per la collocazione di una morsa 1599F/150

10 kg



1240x740x26 mm

	€		
3000 S/PLM	290,00	1	030000150

C31

postazione di lavoro mobile
con ventotto cassetti

- Ventotto cassetti da 588x367 mm montati su guide telescopiche a sfera:
- 19 cassetti altezza 70 mm
- 7 cassetti altezza 140 mm
- 1 cassetto altezza 210 mm
- 1 cassetto altezza 280 mm
- Frontalino del cassetto in alluminio
- Piano dei cassetti protetto da tappetini di gomma espansa
- Robusto piano di lavoro in legno multistrato
- Quattro serrature centralizzate
- Otto ruote Ø 125 mm, 2 fisse e 6 girevoli (2 con freno)

250 kg

2000
kg



C31 O



C31 R



C31 G

h	max
70 mm	30 kg
140 mm	35 kg
210 mm	35 kg
280 mm	40 kg

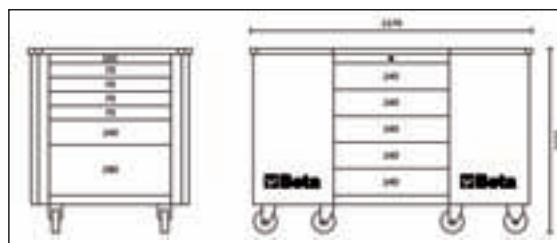
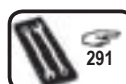

C31 O	€ 4.850,00	1	031000281
C31 G	€ 4.850,00	1	031000282
C31 R	€ 4.850,00	1	031000283

C38 - 3800

cassettiera mobile
con undici cassetti

Caratteristiche principali:

- Undici cassetti montati su guide telescopiche a sfera:
1 cassetto 937x410x122 mm
3 cassetti 570x410x74 mm
2 cassetti 570x410x153 mm
3 cassetti 313x410x74 mm
2 cassetti 313x410x153 mm.
- Piano dei cassetti protetto da tappetini di gomma espansa.
- Capacità di carico statico: 1200 kg.
- 4 ruote ad alta portata Ø 125 mm:
2 fisse e 2 girevoli (entrambe con freno a leva).
- Serratura centralizzata frontale.
- Piano di lavoro di lamiera ricoperto da tappetino in gomma.
- Possibilità di applicazione del portacarta 2499PC e del portaflaconi 2499PF.

114 kg

1200
kg



C38 O



C38 G



C38 R

h	max
74 mm	25 kg
153 mm	30 kg



291

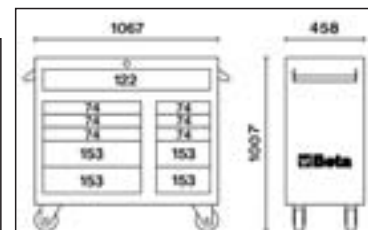
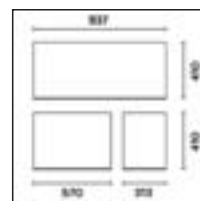

	€			
C38 O	1.210,00	1	038000001	
3800 O/U2T (C38 O+5938U/2T)	2.930,00	1	038000068	268
C38 G	1.210,00	1	038000003	
3800 G/U2T (C38 G+5938U/2T)	2.930,00	1	038000069	268
C38 R	1.210,00	1	038000002	
3800 R/U2T (C38 R+5938U/2T)	2.930,00	1	038000070	268

Beta



C38L

cassettiera laterale
con sette cassetti

Caratteristiche principali:

- Sette cassetti da 410x313 mm, montati su guide telescopiche a sfera:
- 5 cassetti altezza 74 mm
- 2 cassetti altezza 153 mm.
- Piano dei cassetti protetto da tappetini di gomma espansa.
- Serratura di sicurezza centralizzata frontale.
- Piano di lavoro in alluminio antiscivolo.
- Agganciabile su entrambi i lati di C38 e C38A.

45 kg



C38L O



C38L G



C38L R

h	max
74 mm	25 kg
153 mm	30 kg

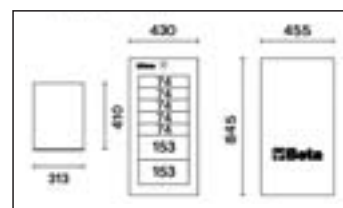

291

	€		
C38L O	590,00	1	038000081
C38L G	590,00	1	038000083
C38L R	590,00	1	038000082

C38L A

antina laterale
con scaffale interno

Caratteristiche principali:

- Serratura frontale.
- Scaffale interno regolabile in altezza.
- Tasca portadocumenti posizionata all'interno dell'antina.
- Piano di lavoro in alluminio antiscivolo.
- Agganciabile su entrambi i lati di C38 e C38A.

18 kg



C38L A O



C38L A G



C38L A R

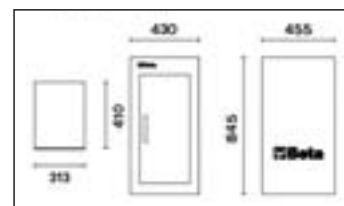

	€		
C38LA-O	225,00	1	038000071
C38LA-G	225,00	1	038000073
C38LA-R	225,00	1	038000072

C38T

cassettiera top
con otto cassetti e vano portautensili

Caratteristiche principali:

- Otto cassetti montati su guide telescopiche a sfera:
- 3 cassetti 570x410x74 mm
- 1 cassetto 570x410x153 mm
- 3 cassetti 313x410x74 mm
- 1 cassetto 313x410x153 mm.
- Vano portautensili.
- Piano dei cassetti protetto da tappetini di gomma espansa.
- Serratura di sicurezza centralizzata frontale.
- Collocabile sul piano di lavoro di C38 e C38A.

64 kg



C38T O



C38T G



C38T R

h	max
74 mm	25 kg
153 mm	30 kg

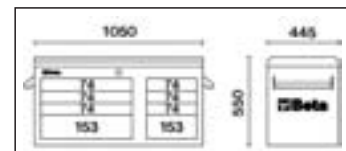
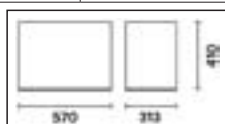

291

	€		
C38T O	770,00	1	038000091
C38T G	770,00	1	038000093
C38T R	770,00	1	038000092

C38C

cassetiera mobile con trentatré cassetti
composta da:



- 1 cassetiera mobile C38
- 2 cassetiere laterali C38L
- 1 cassetiera top C38T

📦 268 kg



C38C O



 h	 max
74 mm	25 kg
153 mm	30 kg



C38C G



C38C R

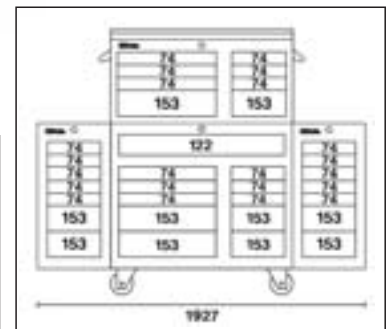
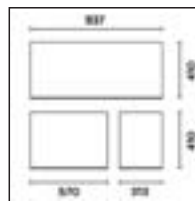

C38C O	€ 3.160,00	📦 1	🖨️ 038000201
C38C G	€ 3.160,00	📦 1	🖨️ 038000203
C38C R	€ 3.160,00	📦 1	🖨️ 038000202



C39/6 - 3900

cassettiera mobile con sei cassetti

Caratteristiche principali:

- Sei cassetti da 588x367 mm, montati su guide telescopiche a sfera:
- 4 cassetti altezza 70 mm
- 1 cassetto altezza 140 mm
- 1 cassetto altezza 280 mm
- Piano dei cassetti protetto da tappetini di gomma espansa.
- Quattro ruote Ø 125 mm:
- 2 fisse e 2 girevoli (una con freno).
- Serratura di sicurezza centralizzata frontale.
- Sistema di apertura posizionato su tutta la lunghezza del cassetto.
- Capacità di carico statico: 1200 kg.
- Piano di lavoro termoplastico.
- Portaflaconi laterali e posteriori integrati.
- Portacarta integrato.
- Struttura portante in alluminio

55 kg

1200 kg



C39 O/6



C39 G/6



C39 R/6

h	max
70 mm	30 kg
140 mm	35 kg
280 mm	40 kg

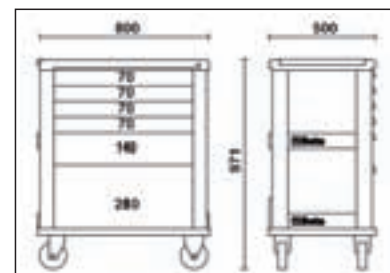
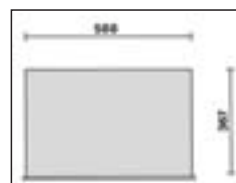

	€			
C39 O/6	1.160,00	1	039000031	
3900 O-6/VI1T (C39 O/6+5904VI/1T)	2.280,00	1	039000114	250
3900 O-6/VU1M (C39 O/6+5904VU/1M)	2.100,00	1	039000117	258
3900 O-6/VG2T (C39 O/6+5904VG/2T)	2.225,00	1	039000124	280
C39 G/6	1.160,00	1	039000032	
3900 G-6/VI1T (C39 G/6+5904VI/1T)	2.280,00	1	039000115	250
3900 G-6/VU1M (C39 G/6+5904VU/1M)	2.100,00	1	039000118	258
3900 G-6/VG2T (C39 G/6+5904VG/2T)	2.225,00	1	039000125	280
C39 R/6	1.160,00	1	039000033	
3900 R-6/VI1T (C39 R/6+5904VI/1T)	2.280,00	1	039000116	250
3900 R-6/VU1M (C39 R/6+5904VU/1M)	2.100,00	1	039000119	258
3900 R-6/VG2T (C39 R/6+5904VG/2T)	2.225,00	1	039000126	280

C39/7 - 3900

cassettiera mobile
con sette cassetti

Caratteristiche principali:

- Sette cassetti da 588x367 mm, montati su guide telescopiche a sfera:
- 5 cassetti altezza 70 mm
- 1 cassetto altezza 140 mm.
- 1 cassetto altezza 210 mm
- Piano dei cassetti protetto da tappetini di gomma espansa.
- Quattro ruote Ø 125 mm:
- 2 fisse e 2 girevoli (una con freno).
- Serratura di sicurezza centralizzata frontale.
- Sistema di apertura posizionato su tutta la lunghezza del cassetto.
- Capacità di carico statico: 1200 kg.
- Piano di lavoro termoplastico.
- Portaflaconi laterali e posteriori integrati.
- Portacarta integrato.
- Struttura portante in alluminio

59 kg

1200
kg



C39 O/7



C39 G/7



C39 R/7

h	max
70 mm	30 kg
140 mm	35 kg
210 mm	35 kg

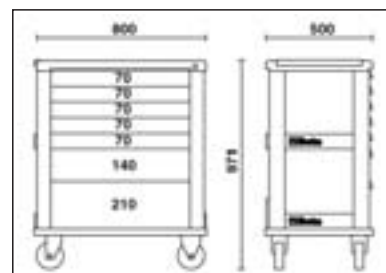

	€			
C39 O/7	1.240,00	1	039000001	
3900 O-7/VU1M (C39 O/7+5904VU/1M)	2.180,00	1	039000137	258
3900 O-7/VG1M (C39 O/7+5904VG/1M)	2.175,00	1	039000147	279
3900 O-7/VU2M (C39 O/7+5904VU/2M)	2.480,00	1	039000154	259
3900 O-7/VU3T (C39 O/7+5904VU/3T)	2.680,00	1	039000157	260
C39 G/7	1.240,00	1	039000002	
3900 G-7/VU1M (C39 G/7+5904VU/1M)	2.180,00	1	039000138	258
3900 G-7/VG1M (C39 G/7+5904VG/1M)	2.175,00	1	039000148	279
3900 G-7/VU2M (C39 G/7+5904VU/2M)	2.480,00	1	039000155	259
3900 G-7/VU3T (C39 G/7+5904VU/3T)	2.680,00	1	039000158	260
C39 R/7	1.240,00	1	039000003	
3900 R-7/VU1M (C39 R/7+5904VU/1M)	2.180,00	1	039000139	258
3900 R-7/VG1M (C39 R/7+5904VG/1M)	2.175,00	1	039000149	279
3900 R-7/VU2M (C39 R/7+5904VU/2M)	2.480,00	1	039000156	259
3900 R-7/VU3T (C39 R/7+5904VU/3T)	2.680,00	1	039000159	260

C39/8 - 3900

cassettiera mobile con otto cassetti

Caratteristiche principali:

- Otto cassetti da 588x367 mm, montati su guide telescopiche a sfera:
- 6 cassetti altezza 70 mm
- 2 cassetti altezza 140 mm
- Piano dei cassetti protetto da tappetini di gomma espansa.
- Quattro ruote Ø 125 mm:
- 2 fisse e 2 girevoli (una con freno).
- Serratura di sicurezza centralizzata frontale.
- Sistema di apertura posizionato su tutta la lunghezza del cassetto.
- Capacità di carico statico: 1200 kg.
- Piano di lavoro termoplastico.
- Portaflaconi laterali e posteriori integrati.
- Portacarta integrato.
- Struttura portante in alluminio

62 kg

1200 kg



C39 O/8



C39 G/8



C39 R/8

h	max
70 mm	30 kg
140 mm	35 kg

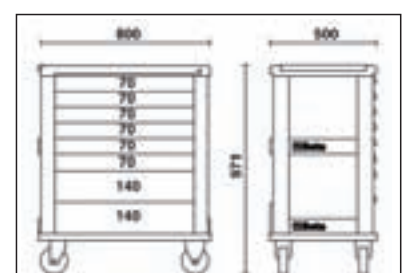
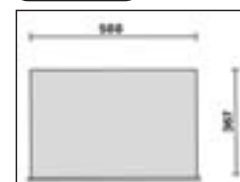

	€			
C39 O/8	1.320,00	1	039000041	
3900 O-8/VI2T (C39 O/8+5904VI/2T)	2.860,00	1	039000177	251
3900 O-8/VG5T (C39 O/8+5904VG/5T)	3.020,00	1	039000184	282
3900 O-8/VI3T (C39 O/8+5904VI/3T)	3.100,00	1	039000187	252
3900 O-8/VU2M (C39 O/8+5904VU/2M)	2.560,00	1	039000191	259
C39 G/8	1.320,00	1	039000042	
3900 G-8/VI2T (C39 G/8+5904VI/2T)	2.860,00	1	039000178	251
3900 G-8/VG5T (C39 G/8+5904VG/5T)	3.020,00	1	039000185	282
3900 G-8/VI3T (C39 G/8+5904VI/3T)	3.100,00	1	039000188	252
3900 G-8/VU2M (C39 G/8+5904VU/2M)	2.560,00	1	039000192	259
C39 R/8	1.320,00	1	039000043	
3900 R-8/VI2T (C39 R/8+5904VI/2T)	2.860,00	1	039000179	251
3900 R-8/VG5T (C39 R/8+5904VG/5T)	3.020,00	1	039000186	282
3900 R-8/VI3T (C39 R/8+5904VI/3T)	3.100,00	1	039000189	252
3900 R-8/VU2M (C39 R/8+5904VU/2M)	2.560,00	1	039000193	259

C39T - 3900T

cassettiera portatile
con quattro cassetti

Caratteristiche principali:

- Quattro cassetti da 588x367 mm, montati su guide telescopiche a sfera:
- 4 cassetti altezza 70 mm
- Serratura centralizzata frontale.
- Capacità di carico del singolo cassetto 15 kg
- Montanti e frontalino del cassetto in alluminio.

📦 25 kg



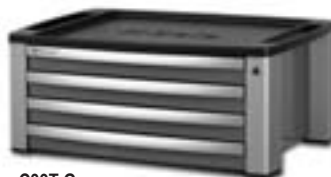

C39T O



C39T G



C39T R

 h	 max
70 mm	30 kg

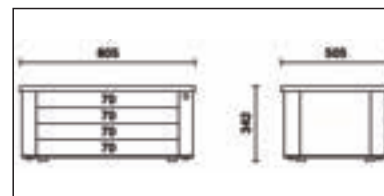

C39T O	€ 790,00	📦 1	🏠 039000101
C39T G	€ 790,00	📦 1	🏠 039000102
C39T R	€ 790,00	📦 1	🏠 039000103

C39/PM

pannello portaminuterie per C39

📦 7,1 Kg



📏 640x440 mm

C39/PM	€ 190,00	📦 1	🏠 039000530
--------	----------	-----	-------------

C39/PU

pannello portautensili per C39

📦 4 Kg



📏 640x440 mm

C39/PU	€ 95,00	📦 1	🏠 039000529
--------	---------	-----	-------------

C39SM - 3939SM

cassettiera speciale mobile tipo Racing SM

Caratteristiche tecniche

- Piano di lavoro in legno multistrato
- Serratura di sicurezza centralizzata frontale.
- 4 ruote Ø 125 mm
- 2 fisse e 2 girevoli (una con freno) con copertura a vista
- Capacità di carico statico: 1200 Kg

Modulo con 7 cassetti

da 588x367 mm, montati
su guide telescopiche a sfera:

- 6 cassetti altezza 70 mm
- 1 cassetto altezza 240 mm
- Piano dei cassetti protetto da tappetini di gomma espansa.
- Sistema di apertura posizionato su tutta la lunghezza del cassetto.
- Frontalino del cassetto in alluminio.

Modulo di servizio

- Cestino portarifiuti integrato
- Vano per rotolo portacarta
- 1 cassetto portaoggetti 420x305x270 mm

125 kg

1200
kg



C39SM O



C39SM R



C39SM G



h	↓ max
70 mm	30 kg
240 mm	40 kg

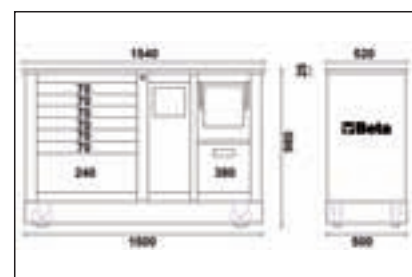
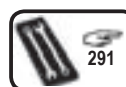

	€			
C39SM O	1.900,00	1	039390001	
C39SM G	1.900,00	1	039390002	
C39SM R	1.900,00	1	039390003	

C39MD - 3939MD

cassettiera speciale mobile Racing MD

Caratteristiche tecniche

- Piano di lavoro in legno multistrato
- Serratura di sicurezza centralizzata frontale.
- 4 ruote Ø 125 mm
- 2 fisse e 2 girevoli (una con freno) con copertura a vista
- Capacità di carico statico: 1200 Kg

Modulo con 7 cassetti
da 588x367 mm, montati
su guide telescopiche a sfera:

- 6 cassetti altezza 70 mm
- 1 cassetto altezza 240 mm
- Piano dei cassetti protetto da tappetini di gomma espansa.
- Sistema di apertura posizionato su tutta la lunghezza del cassetto.
- Frontalino del cassetto in alluminio.

Modulo con 2 cassetti
da 588x367x270 mm e 588x367x380 mm, montati su guide telescopiche a sfera

- Piano dei cassetti protetto da tappetini di gomma espansa
- Sistema di apertura posizionato su tutta la lunghezza dei cassettoni
- Frontalino dei cassettoni in alluminio.

123 kg

1200
kg



C39MD O



C39MD R



C39MD G



h	max
70 mm	30 kg
240 mm	40 kg

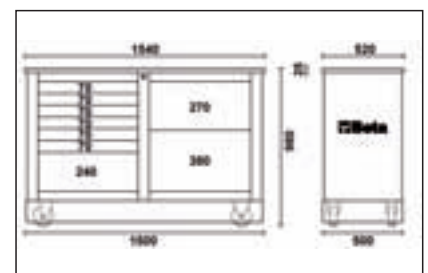
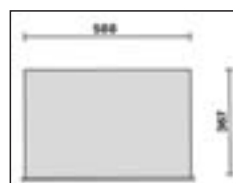
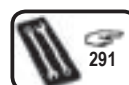

	€			
C39MD O	1.950,00	1	039390101	
C39MD G	1.950,00	1	039390102	
C39MD R	1.950,00	1	039390103	

C41S - 4100S

trolley portautensili
a due moduli sovrapponibili

Caratteristiche principali:

- Struttura in lamiera e piani in materiale plastico: grande robustezza e peso ridotto.
- 2 moduli separabili:
 - 1 cestello superiore,
 - 1 modulo con 1 cassetto altezza 95 mm e 1 cassetto altezza 295 mm.
- Ruote di grosso diametro (160 mm), integrate nella struttura per facilitare il trasporto anche su gradini.
- Serratura centralizzata laterale per la chiusura dei 2 cassetti del modulo inferiore.
- Cassetti montati su guide telescopiche a sfera con doppio gancio di chiusura.
- Impugnatura con manico telescopico in alluminio.
- Portaminuterie integrato nel cestello superiore.
- Cassetto inferiore con doppia guida telescopica

16 kg



	€			
C41S	345,00	1	041000001	
4100S/VU3 (C41S+5915VU/3)	1.044,00	1	041000083	264
4100S/SBK (C41S+5940/SBK)	1.360,00	1	041000104	287

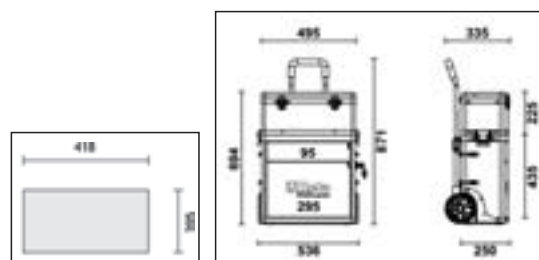

C41H - 4100H

trolley portautensili
a due moduli sovrapponibili

Caratteristiche principali:

- Struttura in lamiera e piani in materiale plastico: grande robustezza e peso ridotto.
- 2 moduli separabili:
 - 1 cestello superiore,
 - 1 cassetta estraibile in materiale plastico altezza 66 mm e 1 cassetto altezza 295 mm.
- Ruote di grosso diametro (160 mm), integrate nella struttura per facilitare il trasporto anche su gradini.
- Serratura centralizzata laterale per la chiusura dei cassetti del modulo inferiore.
- Cassetti montati su guide telescopiche a sfera con doppio gancio di chiusura.
- Impugnatura con manico telescopico in alluminio.
- Portaminuterie integrato nel cestello superiore.
- Cassetto inferiore con doppia guida telescopica

21 kg



	€			
C41H	395,00	1	041000002	
4100H/VU3 (C41H+5915VU/3)	1.094,00	1	041000093	264
4100H/SBK (C41H+5940/SBK)	1.410,00	1	041000114	287

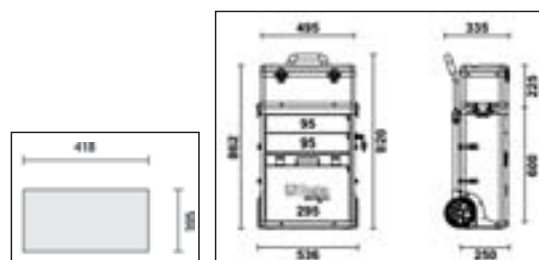

C42S - 4200S

trolley portautensili a due moduli sovrapponibili

Caratteristiche principali:

- Struttura in lamiera e materiale plastico: grande robustezza e peso ridotto.
- 2 moduli separabili:
 - 1 cestello superiore, altezza 220 mm
 - 1 modulo portautensili inferiore con ruote, altezza 330 mm.
- Ruote di grosso diametro (\varnothing 160 mm),
- Manico telescopico regolabile in 3 posizioni.
- Sistema di sgancio rapido dei moduli: agevole e veloce accesso a tutti i diversi scomparti portautensili.
- Cestello superiore con vano portaoggetti interno e 3 portaminuterie integrati nel coperchio

📦 11,5 kg

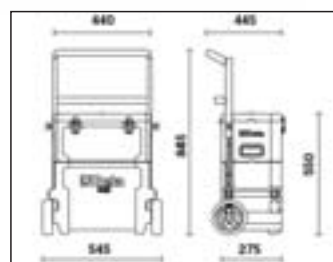

C42S

€ 235,00 1 042000001

C42H - 4200H

trolley portautensili a tre moduli sovrapponibili

Caratteristiche principali:

- Struttura in lamiera e materiale plastico: grande robustezza e peso ridotto.
- 3 moduli separabili:
 - 1 cestello superiore, altezza 220 mm
 - 1 modulo portautensili centrale, altezza 180 mm
 - 1 modulo portautensili inferiore con ruote, altezza 330 mm.
- Ruote di grosso diametro (\varnothing 160 mm),
- Manico telescopico regolabile in 3 posizioni.
- Sistema di sgancio rapido dei moduli: agevole e veloce accesso a tutti i diversi scomparti portautensili.
- Cestello superiore con vano portaoggetti interno e 3 portaminuterie integrati nel coperchio
- Predisposizione per essere utilizzato solamente con 2 moduli.

📦 14 kg

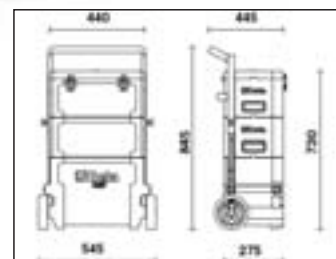

C42H

€ 275,00 1 042000002

C41MS

modulo superiore con portaminuterie integrato per trolley C41

3 kg

C41MS

€ 93,00



1



041000904



495x250x225 mm

C41H/CE

cassetta portautensili con separatori estraibili per minuterie, in materiale plastico per trolley C41

1,3 kg

C41H/CE

€ 23,00



1



041000916



C42 MCH

Modulo centrale aggiuntivo per trolley C42

2,5 kg

C42 MCH

€ 55,00



1



042000105



440x180x275 mm

 **Beta**

C49

armadietto mobile a 2 ante

- 2 ampi ripiani interni
- Serratura frontale
- 4 ruote Ø 125 mm: 2 fisse e 2 girevoli (una con freno)

📦 37,5 kg



C49 O



C49 G



C49 R

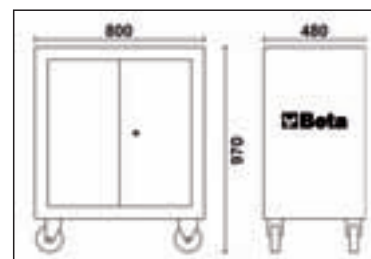

	€	📦	🖨️
C49 O	740,00	1	049000001
C49 G	740,00	1	049000002
C49 R	740,00	1	049000003

C51

carrello

- 3 ripiani ricoperti in gomma millerighe antiscivolo
- Maniglia ergonomica
- Doppia possibilità di fissaggio del ripiano centrale
- Quattro ruote Ø 100 mm:
2 fisse e 2 girevoli (una con freno).
- Capacità di carico statico: 200 kg. (distribuita sui 3 ripiani)

📦 21 kg



C51 O

C51 G

C51 R

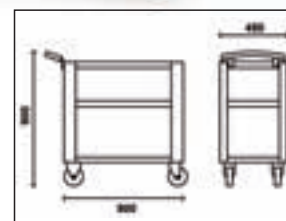

	€	📦	🖨️
C51/O	182,00	1	051000001
C51/G	182,00	1	051000002
C51/R	182,00	1	051000003

CP52



carrello ad alta resistenza

- Struttura in lamiera saldata
- Piano superiore rinforzato
- 4 ruote Ø 125 mm: 2 fisse e 2 girevoli (una con freno)
- Capacità di carico statico: 750 kg (distribuita sui 2 ripiani)



📦 29 kg

**750
kg**

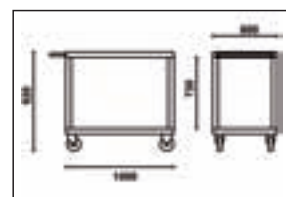

- C51 O 
- C51 G 
- C51 R 



	€		
CP52 O	460,00	1	052000501
CP52 G	460,00	1	052000502
CP52 R	460,00	1	052000503

CX52

carrello NewTeam



Caratteristiche principali:

- Piano superiore ricoperto in ABS.
- Ripiani ricoperti in materiale plastico.
- Quattro ruote Ø 125 mm:
2 fisse e 2 girevoli (una con freno).
- Possibilità di applicazione del portacarta 2499PC
e del portafilaconi 2499PF.
- Capacità di carico statico: 200 kg. (distribuita sui 3 ripiani)



📦 27 kg

**200
kg**

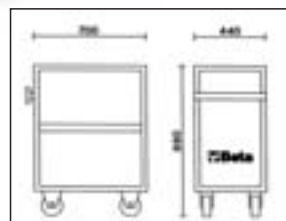

- CX52 O 
- CX52 G 
- CX52 R 



	€		
CX52 O	305,00	1	052000001
CX52 G	305,00	1	052000002
CX52 R	305,00	1	052000003

C53 - 5300

armadietti CargoEvolution

Sono realizzati sulla base di accurate ricerche presso qualificati utilizzatori professionali ed offrono le soluzioni ideali per operare in modo confortevole e razionale.

L'apertura dei pannelli forati delle due antine permette lo sfruttamento anche della loro superficie interna.

Caratteristiche principali:

- 1 cassetto montato su guide telescopiche.
- Possibilità di modificare facilmente la disposizione degli utensili in funzione delle proprie esigenze.
- Posizionamento a parete per mezzo di due asole situate posteriormente.
- Serratura per chiusura contemporanea di antine e cassetto.
- Termoformato vuoto per bussole e accessori da 1/2".
- Le versioni VI e VG differiscono per il diverso allestimento dei supporti portautensili e sono forniti con ganci e supporti (senza utensili).

41 kg



5300

€   

C53	660,00	1	053000001	
C53VI	760,00	1	053000090	
5300VI (C53VI+5953VI)	2.335,00	1	053000015	255
C53VG	760,00	1	053000095	
5300VG (C53VG+5953VG)	2.600,00	1	053000025	288



307

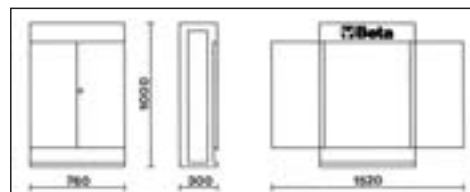

 **Beta**



C54 - 5400

armadietti NewCargo

Caratteristiche simili all'articolo C53.

- Termoformato vuoto per bussole e accessori da 1/2".
- Antine utilizzabili solo da un lato.
- Le versioni VI e VG differiscono per il diverso allestimento dei supporti portautensili e sono forniti con ganci e supporti (senza utensili).

33 kg

	€			
C54 O	560,00	1	054000001	
C54VI O	670,00	1	054000090	
5400 O/VI (C54VI O+5954VI)	1.890,00	1	054000150	256
C54VG O	680,00	1	054000095	
5400 O/VG (C54VG O+5954VG)	2.230,00	1	054000160	289
C54 G	560,00	1	054000002	
C54VI G	670,00	1	054000092	
5400 G/VI (C54VI G+5954VI)	1.890,00	1	054000152	256
C54VG G	680,00	1	054000097	
5400 G/VG (C54VG G+5954VG)	2.230,00	1	054000162	289
C54 R	560,00	1	054000003	
C54VI R	670,00	1	054000093	
5400 R/VI (C54VI R+5954VI)	1.890,00	1	054000154	256
C54VG R	680,00	1	054000098	
5400 R/VG (C54VG R+5954VG)	2.230,00	1	054000164	289



5400 O



C54 O

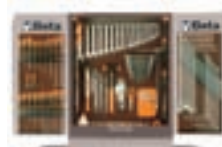

C54 G



C54 R

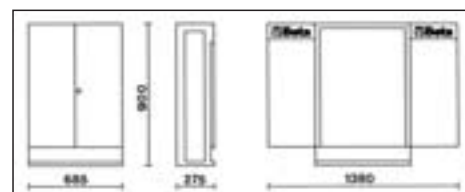
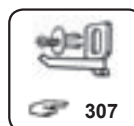

Beta



C57A - 5700A

banco da lavoro MasterCargo

• Modello con parete portautensili (C57P) e una cassetiera.

Cassetiera formata da cinque cassetti da 600x370 mm di cui 3 altezza 100 mm e 2 altezza 175 mm montati su guide telescopiche con scorrimento su cuscinetti per sopportare pesi rilevanti. Serratura centralizzata.

Parete portautensili anche appendibile mediante asole.

Tapparella in alluminio, manovrabile verticalmente, con serratura.

Tre pannelli forati amovibili per il sostegno degli utensili.

Piano di lavoro in legno multistrato, rivestito in laminato plastico con tre fori per la collocazione di una morsa 1599F/150 da ordinare separatamente.

📦 205 kg



1800 kg

C57A O



C57A G



C57A R



5700A O

	€	📦	🖨️	🔗
C57A O	3.220,00	1	057000001	
5700A O/VI (C57A O+5957VI)	5.540,00	1	057000196	257
5700A O/VG (C57A O+5957VG)	5.880,00	1	057000197	290
C57A G	3.220,00	1	057000201	
5700A G/VI (C57A G+5957VI)	5.540,00	1	057000396	257
5700A G/VG (C57A G+5957VG)	5.880,00	1	057000397	290
C57A R	3.220,00	1	057000401	
5700A R/VI (C57A R+5957VI)	5.540,00	1	057000596	257
5700A R/VG (C57A R+5957VG)	5.880,00	1	057000597	290



h	max
100 mm	30 kg
175 mm	40 kg

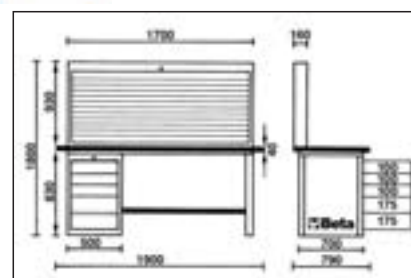

C57D

banco da lavoro MasterCargo

• Modello con una cassetiera

Cassetiera formata da cinque cassetti da 600x370 mm di cui 3 altezza 100 mm e 2 altezza 175 mm montati su guide telescopiche con scorrimento su cuscinetti per sopportare pesi rilevanti. Serratura centralizzata.

Piano di lavoro in legno multistrato, rivestito in laminato plastico con tre fori per la collocazione di una morsa 1599F/150 da ordinare separatamente.

📦 158 kg



1800 kg

C57D O



h	max
100 mm	30 kg
175 mm	40 kg



C57D G



C57D R

	€	📦	🖨️	🔗
C57D O	2.100,00	1	057000004	
C57D G	2.100,00	1	057000204	
C57D R	2.100,00	1	057000404	

C57B - 5700B

banco da lavoro MasterCargo

- Modello con parete portautensili (C57P) e due cassettiere.

Cassettiera formata da cinque cassetti da 600x370 mm di cui 3 altezza 100 mm e 2 altezza 175 mm montati su guide telescopiche con scorrimento su cuscinetti per sopportare pesi rilevanti. Serratura centralizzata.

Parete portautensili anche appendibile mediante asole.

Tapparella in alluminio, manovrabile verticalmente, con serratura.

Tre pannelli forati amovibili per il sostegno degli utensili.

Piano di lavoro in legno multistrato, rivestito in laminato plastico con tre fori per la collocazione di una morsa 1599F/150 da ordinare separatamente.

📦 243 kg

	€	📦	🚚	🔧
C57B O	3.820,00	1	057000002	
5700B O/VI (C57B O+5957VI)	6.140,00	1	057000198	257
5700B O/VG (C57B O+5957VG)	6.480,00	1	057000199	290
C57B G	3.820,00	1	057000202	
5700B G/VI (C57B G+5957VI)	6.140,00	1	057000398	257
5700B G/VG (C57B G+5957VG)	6.480,00	1	057000399	290
C57B R	3.820,00	1	057000402	
5700B R/VI (C57B R+5957VI)	6.140,00	1	057000598	257
5700B R/VG (C57B R+5957VG)	6.480,00	1	057000599	290



1800 kg

C57B O



C57B G



C57B R



5700B O

h	max
100 mm	30 kg
175 mm	40 kg

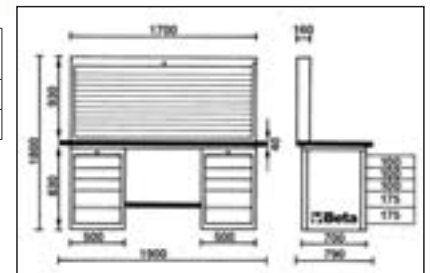
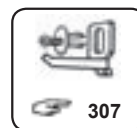

C57C

banco da lavoro MasterCargo

- Modello con due cassettiere.

Cassettiera formata da cinque cassetti da 600x370 mm di cui 3 altezza 100 mm e 2 altezza 175 mm montati su guide telescopiche con scorrimento su cuscinetti per sopportare pesi rilevanti. Serratura centralizzata.

Piano di lavoro in legno multistrato, rivestito in laminato plastico con tre fori per la collocazione di una morsa 1599F/150 da ordinare separatamente.

📦 196 kg

	€	📦	🚚	🔧
C57C O	2.670,00	1	057000003	
C57C G	2.670,00	1	057000203	
C57C R	2.670,00	1	057000403	

1800 kg



C57C O

h	max
100 mm	30 kg
175 mm	40 kg



C57C G



C57C R

C57P - 5700P

parete portautensili MasterCargo

Parete portautensili anche appendibile mediante asole.

Tapparella in alluminio, manovrabile verticalmente, con serratura.

Tre pannelli forati amovibili per il sostegno degli utensili.

📦 46 kg



C57P O

1700 mm

930 mm



C57P G



5700P O/U



307



C57P R

	€	📦	🖨️	🔗
C57P O	1.230,00	1	057000020	
5700P O/U (C57P O+5957U)	2.870,00	1	057000195	269
C57P G	1.230,00	1	057000220	
5700P G/U (C57P G+5957U)	2.870,00	1	057000395	269
C57P R	1.230,00	1	057000420	
5700P R/U (C57P R+5957U)	2.870,00	1	057000595	269

5700LAMP

lampada per banco MasterCargo

- Robusta struttura in lamiera composta da quattro elementi; completa di viti per l'assemblaggio.
- Portalamпада con tubo fluorescente da 36W.
- Alimentazione 230V.
- Fornito senza cavo.

📦 9 kg



5700LAMP + 5700A O

	€	📦	🖨️
5700LAMP	220,00	1	057000005

C58A - 5800A

banco da lavoro
con parete Basic

Cassettiera composta da sei cassetti da 460x290 mm di cui 4 altezza 80 mm e 2 altezza 160 mm montati su guide telescopiche con serratura centralizzata frontale.

Pannello frontale forato per il sostegno degli utensili.
Possibilità di posizionamento anche a parete per mezzo di asole situate posteriormente.

Piano di lavoro in legno multistrato, rivestito in laminato plastico, con due fori per il fissaggio di una morsa 1599F/100 da ordinare separatamente.

📦 79 kg



C58A

5800A/U

h	max
80 mm	25 kg
160 mm	35 kg

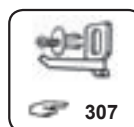
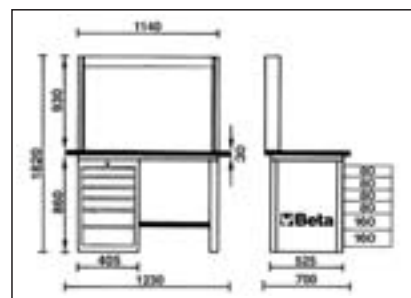

	€	📦	🔧	📦	
C58A	1.320,00	1	058000001		
5800A/U (C58A+5958U)	2.195,00	1	058000191	270	

C58B - 5800B

banco da lavoro
con parete BasicPlus

Cassettiera composta da sei cassetti da 460x290 mm di cui 4 altezza 80 mm e 2 altezza 160 mm montati su guide telescopiche con serratura centralizzata frontale.

La versione BasicPlus si differenzia per la chiusura a tapparella in alluminio con due pannelli forati amovibili per il sostegno degli utensili.
Struttura realizzata in lamiera di acciaio.

Piano di lavoro in legno multistrato, rivestito in laminato plastico, con due fori per il fissaggio di una morsa 1599F/100 da ordinare separatamente.

📦 95 kg



C58B

5800B/U

h	max
80 mm	25 kg
160 mm	35 kg

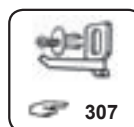
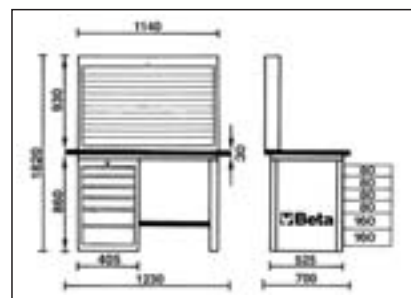

	€	📦	🔧	📦	
C58B	1.870,00	1	058000002		
5800B/U (C58B+5958U)	2.750,00	1	058000192	270	

C58C

banco da lavoro

- Abbinabile alle pareti C58P/A e C58P/B.

Cassettiera composta da sei cassetti da 460x290 mm di cui 4 altezza 80 mm e 2 altezza 160 mm montati su guide telescopiche con serratura centralizzata frontale.

Piano di lavoro in legno multistrato, rivestito in laminato plastico, con due fori per il fissaggio di una morsa 1599F/100 da ordinare separatamente.

📦 66 kg

C58C € 1.050,00 1 058000003



h	max
80 mm	25 kg
160 mm	35 kg

C58P/A - 5800UP/A

parete portautensili Basic

- Soluzione aperta.

📦 15 kg

C58P/A € 300,00 1 058000020
 5800P/AU (C58P/A+5958U) € 1.176,00 1 058000196 270



C58P/B - 5800UP/B

parete portautensili BasicPlus

- Soluzione con chiusura a tapparella in alluminio verniciato e serratura di chiusura.
- Due pannelli forati amovibili per il sostegno degli utensili.

📦 31 kg

C58P/B € 860,00 1 058000021
 5800P/BU (C58P/B+5958U) € 1.735,00 1 058000197 270



C56

banco da lavoro

- Piano di lavoro in lamiera verniciata con bordo perimetrale
 - Struttura in acciaio con 6 gambe di sostegno
 - Capacità di carico statico: 1.200 kg
 - Abbinabile alla parete C57P
- non fissabile al piano di lavoro.
- Due cassetti dotati di serratura.
 - Predisposizione per il fissaggio al pavimento.

📦 82 kg

	€	📦	🏠
C56 O	653,00	1	056000201
C56 G	653,00	1	056000202
C56 R	653,00	1	056000203



C56M

banco da lavoro

- Piano di lavoro in metallo rivestito per metà da lastra in alluminio antiscivolo e per metà da tappeto in gomma asportabile.
 - Sottopiano in massello di legno.
 - Capacità di carico statico: 800 kg
 - Abbinabile alla parete C57P
- non fissabile al piano di lavoro.
- Tre cassetti dotati di serratura.
 - Predisposizione per il fissaggio al pavimento.

📦 95 kg

	€	📦	🏠
C56M O	970,00	1	056000050
C56M G	970,00	1	056000053
C56M R	970,00	1	056000054



C58M

banco da lavoro

- Piano di lavoro in metallo interamente rivestito da un tappetino in gomma antiscivolo asportabile.
 - Sottopiano in massello di legno.
 - Capacità di carico statico: 800 kg.
 - Abbinabile alla parete C58P
- non fissabile al piano di lavoro.
- 2 cassetti dotati di serratura.
 - Predisposizione per il fissaggio al pavimento.
 - Possibilità di applicazione opzionale del piano di lavoro in alluminio C58M/PA.

📦 65 kg

	€	📦	🏠
C58M O	635,00	1	058000300
C58M G	635,00	1	058000302
C58M R	635,00	1	058000303



C58M/PA

piano in alluminio godronato per banco da lavoro C58M

📦 4,5 kg

	€	📦	🏠
C58M/PA	240,00	1	058000350



C59A - 5900A

banco da lavoro "Endurance" con 1 cassetiera da sei cassetti

Caratteristiche principali:

- Ripiano in legno multistrato con fori per la collocazione di una morsa 1599F/125 (da ordinare separatamente).
- 6 cassetti 588x367 mm, montati su guide telescopiche a sfera:
- 4 cassetti altezza 70 mm
- 1 cassetto altezza 140 mm
- 1 cassetto altezza 280 mm
- Piano dei cassetti protetto da tappetini di gomma espansa.
- Frontalino dei cassetti in Nylon ad alta resistenza.
- Cassettiere predisposte per l'inserimento di termoformati.
- Serratura di sicurezza centralizzata frontale.
- Ripiano inferiore portaoggetti.
- predisposizione per portacarta (2400S-R/PC) e portafilaconi (2400S/PF) da ordinare separatamente.

115 kg

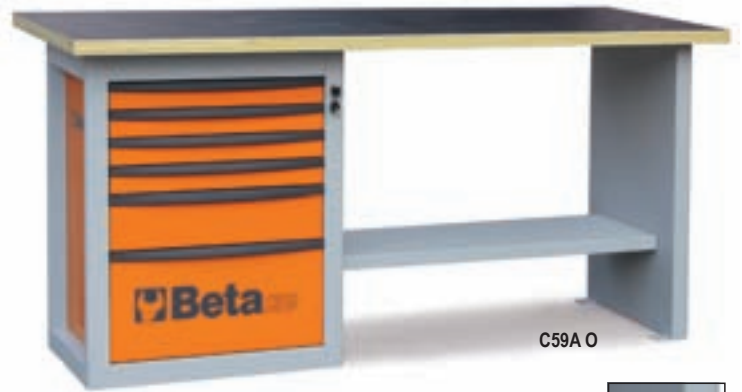

C59A O

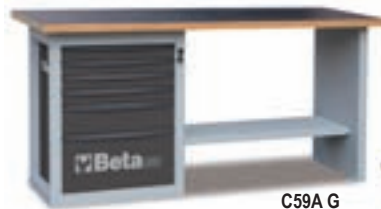

C59A G

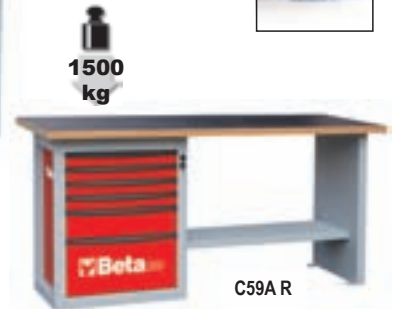

C59A R



h	max
70 mm	25 kg
140 mm	30 kg
280 mm	35 kg

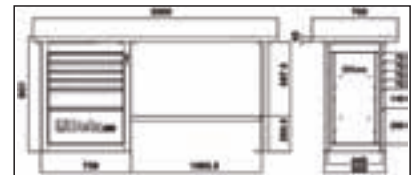

	€		
C59A O	1.200,00	1	059000001
C59A G	1.200,00	1	059000021
C59A R	1.200,00	1	059000041

C59B - 5900B

banco da lavoro "Endurance" con 2 cassettiere da sei cassetti

Caratteristiche principali:

- Ripiano in legno multistrato con fori per la collocazione di una morsa 1599F/125 (da ordinare separatamente).
- 12 cassetti 588x367 mm, montati su guide telescopiche a sfera:
- 8 cassetti altezza 70 mm
- 2 cassetti altezza 140 mm
- 2 cassetti altezza 280 mm
- Piano dei cassetti protetto da tappetini di gomma espansa.
- Possibilità di inserimento termoformati.
- Serratura di sicurezza centralizzata frontale.
- Ripiano inferiore portaoggetti.
- predisposizione per portacarta (2400S-R/PC) e portafilaconi (2400S/PF) da ordinare separatamente.

155 kg



C59B O



C59B G



C59B R



h	max
70 mm	25 kg
140 mm	30 kg
280 mm	35 kg

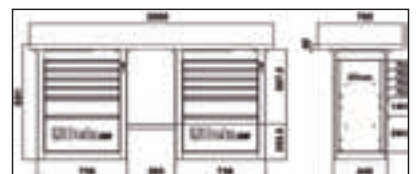

	€		
C59B O	1.620,00	1	059000002
C59B G	1.620,00	1	059000022
C59B R	1.620,00	1	059000042

C59C - 5900C

banco da lavoro "Endurance" con 1 cassetiera da sei cassetti, modello corto

Caratteristiche principali:

- Ripiano in legno multistrato con fori per la collocazione di una morsa 1599F/125 (da ordinare separatamente).
- 6 cassetti 588x367 mm, montati su guide telescopiche a sfera:
 - 4 cassetti altezza 70 mm
 - 1 cassetto altezza 140 mm
 - 1 cassetto altezza 280 mm
- Piano dei cassetti protetto da tappetini di gomma espansa.
- Possibilità di inserimento termoformati.
- Serratura di sicurezza centralizzata frontale.
- Ripiano inferiore portaoggetti.
- predisposizione per portacarta (2400S-R/PC) e portaflaconi (2400S/PF) da ordinare separatamente.

105 kg



C59C O

1500 kg



C59C G



C59C R



h	max
70 mm	25 kg
140 mm	30 kg
280 mm	35 kg

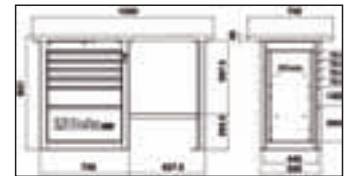

	€		
C59C O	1.080,00	1	059000003
C59C G	1.080,00	1	059000023
C59C R	1.080,00	1	059000043

Beta



Assortimenti di utensili per contenitori

ATTENZIONE!



Alcuni assortimenti, illustrati nelle prossime pagine, presentano variazioni:

- inserimento di nuovi utensili
- razionalizzazione degli utensili proposti.

Sugeriamo quindi di esaminare accuratamente la composizione di tali assortimenti e consultare le caratteristiche dell'articolo di riferimento.

Per manutenzioni industriali

Beta n.	N. pezzi	€			
5902VI	105	1.205,00	1	059020041	249
5904VI/1T	98	1.121,00	1	059040161	250
5904VI/2T	151	1.535,00	1	059040163	251
5904VI/3T	142	1.780,00	1	059040167	252
5908VI/2T	232	2.320,00	1	059080105	253

Beta n.	N. pezzi	€			
5910VI/3T	256	4.110,00	1	059100062	254
5953VI	137	1.575,00	1	059530075	255
5954VI	115	1.220,00	1	059540075	256
5957VI	165	2.325,00	1	059570027	257



Per interventi universali

Beta n.	N. pezzi	€			
5904VU/1M	91	939,00	1	059040201	258
5904VU/2M	152	1.240,00	1	059040202	259
5904VU/3T	146	1.445,00	1	059040203	260
5915VU/0	35	295,00	1	059150120	261
5915VU/1	45	363,00	1	059150124	262
5915VU/2	49	309,00	1	059150127	263
5915VU/3	75	699,00	1	059150126	264

Beta n.	N. pezzi	€			
5915VU/4	80	886,00	1	059150145	265
5915VU/AS	71	723,00	1	059150131	266
5923VU/1T	86	761,00	1	059230102	267
5938U/2T	210	1.720,00	1	059380062	268
5957U	132	1.635,00	1	059570026	269
5958U	86	876,00	1	059580024	270

Per elettronica, elettrotecnica e idraulica

Beta n.	N. pezzi	€			
5980ET/A	60	622,00	1	059800261	271
5980ET/B	64	916,00	1	059800263	272
5980/MQ	46	1.147,00	1	059800254	273



Beta n.	N. pezzi	€			
5980EL/A	57	666,00	1	059800239	274
5980EL/B	98	933,00	1	059800240	275
5980ID	35	423,00	1	059800321	276

Per autoriparazione e movimento terra

Beta n.	N. pezzi	€			
5902MT	106	1.610,00	1	059020043	277
5902MT/AS	99	1.660,00	1	059020044	278
5904VG/1M	76	935,00	1	059040197	279
5904VG/2T	99	1.067,00	1	059040191	280
5904VG/3	132	1.630,00	1	059040192	281
5904VG/5T	153	1.700,00	1	059040196	282
5905VG/1	94	1.475,00	1	059050157	283

Beta n.	N. pezzi	€			
5905VG/2	118	1.425,00	1	059050144	284
5908VG/2T	212	2.850,00	1	059080117	285
5910VG/3T	202	4.050,00	1	059100067	286
5953VG	147	1.845,00	1	059530085	288
5954VG	138	1.550,00	1	059540085	289
5957VG	189	2.660,00	1	059570028	290

Per motoriparazione

Beta n.	N. pezzi	€			
5940SBK	133	1.016,00	1	059400071	287

Manutenzioni industriali



19,5 kg

N. pezzi/Descrizione

- 4 cacciaspina Ø 3 - 4 - 5 - 8 mm
- 1 bulino Ø 3 mm
- 1 scalpelli piatti nervati 200 mm
- 26 chiavi combinate 6÷32 mm
- 12 chiavi a forchetta 6x7 - 8x9 - 10x11 - 12x13 - 14x15 - 16x17 - 18x19 - 20x22 - 21x23 - 24x26 - 25x28 - 30x32 mm
- 9 chiavi maschio esagonale piegate
 ○ 1,5 - 2 - 2,5 - 3 - 4 - 5 - 6 - 8 - 10 mm
- 1 chiave regolabile a rullino 300 mm
- 13 chiavi a bussola poligonali 1/2" con guida ○ 10÷22 mm
- 1 prolunga - 1/2" 125 mm
- 1 prolunga - 1/2" 255 mm
- 1 snodo 1/2"
- 1 quadro maschio 1/2" con spina scorrevole
- 1 cricchetto reversibile 1/2" Ⓢ
- 1 pinze regolabili cerniera chiusa 250 mm
- 1 pinza autobloccante 240 mm
- 1 tronchese a grande effetto taglienti diagonali \sphericalangle 160 mm
- 1 cesoia a doppia leva diritta 250 mm

Beta N.

- 31
- 32
- 35
- 42/S26
- 55/S12
- 96N/SC9
- 111
- 920B/SB13
- 920/21
- 920/22
- 920/25
- 920/42
- 920/55
- 1048
- 1052
- 1084BM
- 1122

N. pezzi/Descrizione

- 1 forbici per elettricisti lame diritte
- 1 pinza universale = 180 mm
- 1 pinza a becchi mezzotondi diritti ● 160 mm
- 8 giravite lama piatta ● 2,5x50 - 3x75 - 3,5x100 - 4x125 - 5,5x125 - 6,5x150 - 8x200 - 10x200 mm
- 4 giravite per viti con impronta a croce Phillips® Ⓢ PH0x60 - PH1x80 - PH2x100 - PH3x150 mm
- 1 martello tipo tedesco 500 g
- 1 mazzuola antirimbalzo Ø 40 mm
- 1 punta per tracciare
- 1 flessometro 5 m
- 1 spessimetro
- 5 lime a taglio mezzodolce 200 mm
- 1 seghetto
- 1 oliatore in metallo a pressione 300 cc
- 1 cutter con lama a settori
- 1 lampada magnetica snodata a LED

Beta N.

- 1128BMX
- 1150BM
- 1166BM
- 1260
- 1262
- 1370
- 1392
- 1688A
- 1692
- 1708/20
- 1719BMA/S5
- 1726BM
- 1751
- 1771BM
- 1837

	5902VI	€ 1.205,00	059020041
	2200S-O/VI (C22S-O+5902VI)	€ 1.530,00	022000421
	2200S-G/VI (C22S-G+5902VI)	€ 1.530,00	022000422
	2200S-R/VI (C22S-R+5902VI)	€ 1.530,00	022000423

	2300S-O/VI (C23S-O+5902VI)	€ 1.605,00	023000451
	2300S-G/VI (C23S-G+5902VI)	€ 1.605,00	023000452
	2300S-R/VI (C23S-R+5902VI)	€ 1.605,00	023000453
	2300SC-O/VI (C23SC O+5902VI)	€ 1.650,00	023000481

	2300SC-G/VI (C23SC G+5902VI)	€ 1.650,00	023000482
	2300SC-R/VI (C23SC R+5902VI)	€ 1.650,00	023000483
	2500/VI1 (C25+5902VI)	€ 1.775,00	025000079

5904VI/1T

assortimento di 98 utensili in termoformato

Manutenzioni industriali



T80 T15 T16



T153 T131 T145 T236



T234 T33 T208 T68

14,5 kg

N. pezzi/Descrizione





- 19 chiavi a bussola esagonali 1/2" \odot 10+24 - 26 - 27 - 30 - 32 mm
- 5 chiavi a bussola maschio esagonale 1/2" \odot
5 - 6 - 8 - 10 - 12 mm
- 1 prolunga - 1/2" 125 mm
- 1 prolunga - 1/2" 255 mm
- 1 snodo 1/2"
- 1 quadro maschio 1/2" con spina scorrevole
- 1 cricchetto reversibile 1/2" \oplus
- 21 chiavi combinate 6+21 mm
- chiavi combinate 22-24-27-30-32 mm
- 1 pinze regolabili cerniera chiusa 250 mm
- 1 pinza autobloccante 240 mm
- 1 tronchesi a grande effetto taglienti diagonali ∇ 160 mm
- 1 pinza universale \equiv 180 mm
- 1 pinza a becchi mezzotondi dritti \bullet 160 mm
- 1 pinze becchi dritti per anelli elastici, per fori \odot 180 mm
- 1 pinze becchi piegati per anelli elastici, per fori \odot 170 mm





Beta N.	TR
920A	T80
920ME	T80
920/21	T80
920/22	T80
920/25	T80
920/42	T80
920/55	T80
42	T15
42	T16
1048	T153
1052	T153
1084BM	T131
1150BM	T131
1166BM	T131
1032	T145
1034	T145



N. pezzi/Descrizione

- 1 pinze becchi dritti per anelli elastici, per alberi \bullet 175 mm
- 1 pinze becchi piegati per anelli elastici, per alberi \bullet 175 mm
- 5 lime a taglio mezzodolce 200 mm
- 2 scalpelli piatti nervati 100 - 200 mm
- 1 martello tipo tedesco 300 g
- 1 mazzuola con battenti in materiale plastico \varnothing 35 mm
- 8 chiavi a forchetta 6x7 - 8x9 - 10x11 - 12x13 - 14x15 - 16x17 - 18x19 - 20x22 mm
- 9 chiavi maschio esagonale piegate \odot 1,5 - 2 - 2,5 - 3 - 4 - 5 - 6 - 8 - 10 mm
- 4 giravite lama piatta \bullet 3x75 - 4x100 - 5,5x150 - 6,5x150 mm
- 3 giravite per viti con impronta a croce Phillips® \oplus PH0x60 - PH1x80 - PH2x100 mm
- 6 chiavi a T maschio esagonale \odot 2,5 - 3 - 4 - 5 - 6 - 8 mm

Beta N.	TR
1036	T145
1038	T145
1719BMA8/S5	T236
35	T234
1370	T234
1390	T234
55	T33
96/SC9	T33
1260	T208
1262	T208
951	T68

	€	IT
5904VI/1T	1.121,00	059040161
 2300ST-OM1T (C23ST O+5904VI/1T)	1.590,00	023000671
 2300ST-GM1T (C23ST G+5904VI/1T)	1.590,00	023000672
 2300ST-RV1T (C23ST R+5904VI/1T)	1.590,00	023000673
 2400S5-OM1T (C24S5/O+5904VI/1T)	1.685,00	024002504

	€	IT
 2400S5-GM1T (C24S5/G+5904VI/1T)	1.685,00	024002505
 2400S5-RV1T (C24S5/R+5904VI/1T)	1.685,00	024002506
 2400S6-OM1T (C24S6/O+5904VI/1T)	1.750,00	024002614
 2400S6-GM1T (C24S6/G+5904VI/1T)	1.750,00	024002615
 2400S6-RV1T (C24S6/R+5904VI/1T)	1.750,00	024002616

	€	IT
 3900 O-6V1T (C39 O/6+5904VI/1T)	2.280,00	039000114
 3900 G-6V1T (C39 G/6+5904VI/1T)	2.280,00	039000115
 3900 R-6V1T (C39 R/6+5904VI/1T)	2.280,00	039000116

Manutenzioni industriali



26,5 kg

N. pezzi/Descrizione

- 16 chiavi combinate 6÷21 mm
- 5 chiavi combinate 22 - 24 - 27 - 30 - 32 mm
- 5 cacciaspina Ø 2 - 3 - 4 - 5 - 6 mm
- 1 bulino Ø 4 mm
- 12 chiavi a forchetta 6x7 - 8x9 - 10x11 - 12x13 - 14x15 - 16x17 - 18x19 - 20x22 - 21x23 - 24x26 - 27x29 - 30x32 mm
- 9 chiavi maschio esagonale piegate Ø 1,5 - 2 - 2,5 - 3 - 4 - 5 - 6 - 8 - 10 mm
- 9 giravite lama piatta ● 3x75 - 3,5x100 - 4x100 - 4x150 - 5,5x100 - 5,5x150 - 6,5x150 - 8x150 - 10x200 mm
- 2 giravite nano lama piatta ● 4x30 - 6,5x30 mm
- 6 giravite per viti con impronta a croce Phillips® ● PH0x60 - PH0x100 - PH1x80 - PH1x120 - PH2x100 - PH2x150 mm
- 7 chiavi maschio per viti con impronta Torx® ● T6-T7-T8-T9-T10-T15-T20
- 5 chiavi a bussola maschio esagonale 1/2" ○ 5 - 6 - 8 - 10 - 12 mm
- 1 prolunga - 1/2" 125 mm
- 1 prolunga - 1/2" 255 mm
- 1 snodo 1/2"
- 1 quadro maschio 1/2" con spina scorrevole
- 1 cricchetto reversibile 1/2" ⊕
- 19 chiavi a bussola esagonali 1/2" ○ 10÷24 - 26 - 27 - 30 - 32 mm
- 8 chiavi a tubo doppie poligonali 6x7 - 8x9 - 10x11 - 12x13 - 14x15 - 16x17 - 18x19 - 20x22 mm
- 1 spine di manovra per chiavi a tubo 1 - 2
- 1 spine di manovra per chiavi a tubo 1 - 2
- 6 chiavi a T maschio esagonale ○ 2,5 - 3 - 4 - 5 - 6 - 8 mm
- 1 pinza universale = 180 mm
- 1 pinza a becchi mezzotondi diritti ● 160 mm
- 1 tronchesi a grande effetto taglianti diagonali ⚡ 160 mm

Beta N.	TR
42	T15
42	T16
31	T31
32	T31
55	T31
96N/SC9	T31
1260	T167
1260N	T167
1262	T202
1267TX	T205
920ME	T80
920/21	T80
920/22	T80
920/25	T80
920/42	T80
920/55	T80
920A	T80
930	T73
940/1	T73
940/2	T73
951	T68
1150BM	T131
1166BM	T131
1084BM	T131

N. pezzi/Descrizione

- 1 pinze regolabili cerniera chiusa 250 mm
- 1 pinza autobloccante 240 mm
- 1 pinze becchi dritti per anelli elastici, per fori ○ 180 mm
- 1 pinze becchi piegati per anelli elastici, per fori ○ 170 mm
- 1 pinze becchi dritti per anelli elastici, per alberi ● 175 mm
- 1 pinze becchi piegati per anelli elastici, per alberi ● 175 mm
- 1 pinze becchi dritti per anelli elastici, per fori ○ 140 mm
- 1 pinze becchi piegati per anelli elastici, per fori ○ 225 mm
- 1 pinze becchi dritti per anelli elastici, per alberi ● 140 mm
- 1 pinze becchi piegati per anelli elastici, per alberi ● 225 mm
- 1 martello tipo tedesco 400 g
- 1 mazzuola con battenti in materiale plastico Ø 35 mm
- 1 lime a taglio mezzodolce 200 mm
- 1 lime a taglio mezzodolce 200 mm
- 1 lime a taglio mezzodolce 200 mm
- 1 calibro digitale a corsoio
- 1 riga flessibile graduata 300 mm
- 1 flessometro 5 m termoformato vuoto
- 1 rivettatrice 250 mm
- 100 rivetti 2,9x6 mm
- 100 rivetti 3,2x8 mm
- 100 rivetti 3,8x10 mm
- 100 rivetti 4x12 mm
- 100 rivetti 4,8x12 mm
- 1 cesoia a lame larghe diritte 250 mm
- 1 forbici per elettricisti lame dritte
- 1 seghetto
- 1 lame per seghetti
- 1 oliatore in plastica a pressione 200 cc termoformato vuoto

Beta N.	TR
1048	T153
1052	T153
1032	T145
1034	T145
1036	T145
1038	T145
1032	T146
1034	T146
1036	T146
1038	T146
1370	T231
1390	T231
1719BMA8/T	T231
1719BMA8/P	T231
1719BMA8/M	T231
1651DGT	T296
1682	T296
1691BG	T296
VP6	T296
1741B	T281
1741RV...K	T281
1741RV...K	T281
1741RV...K	T281
1741RV...K	T281
1741RV...K	T281
1112	T285
1128BM	T285
1726	T285
1728BM	T285
1753	T285
VP6	VP6

€

5904VI/3T	1.780,00	059040167
2400S8-OVI3T (C24S8/O+5904VI/3T)	2.520,00	024002817
2400S8-GVI3T (C24S8/G+5904VI/3T)	2.520,00	024002818
2400S8-RVI3T (C24S8/R+5904VI/3T)	2.520,00	024002819
2800 OVI3T (C28 O+5904VI/3T)	3.610,00	028000317

€

2800 GVI3T (C28 G+5904VI/3T)	3.610,00	028000318
2800 RVI3T (C28 R+5904VI/3T)	3.610,00	028000319
3900 O-8VI3T (C39 O/8+5904VI/3T)	3.100,00	039000187
3900 G-8VI3T (C39 G/8+5904VI/3T)	3.100,00	039000188
3900 R-8VI3T (C39 R/8+5904VI/3T)	3.100,00	039000189

€

2400SAXL-OVI3T (C24SA-XL/7 O+5904VI/3T)	2.670,00	024002451
2400SAXL-GVI3T (C24SA-XL/7 G+5904VI/3T)	2.670,00	024002452
2400SAXL-RVI3T (C24SA-XL/7 R+5904VI/3T)	2.670,00	024002453

Manutenzioni industriali

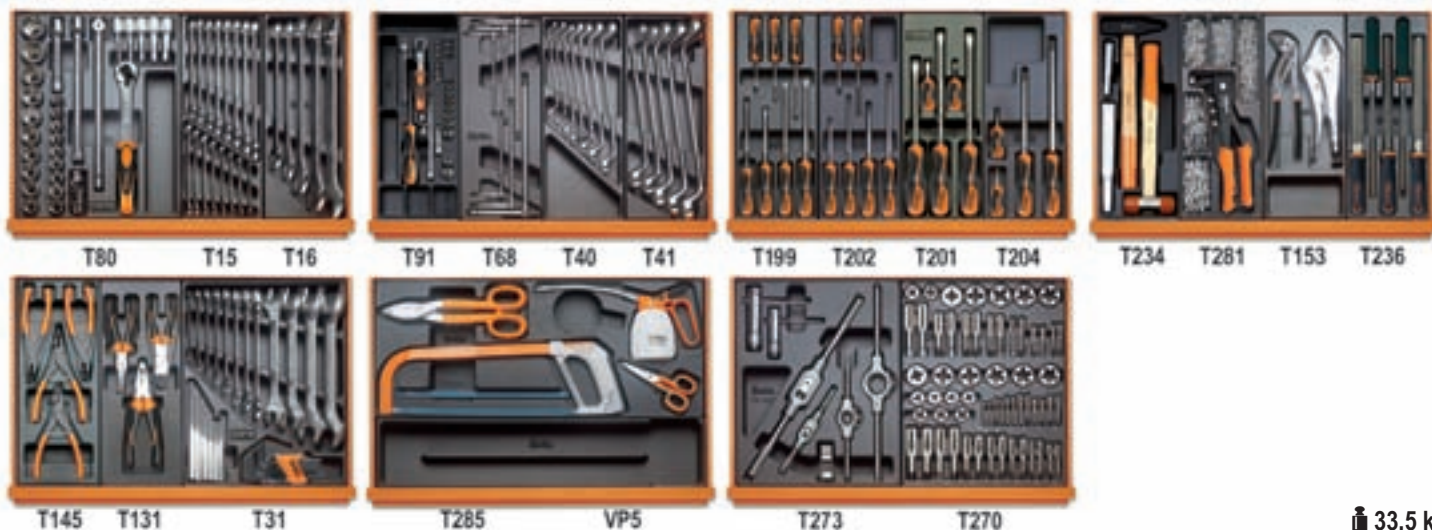

33,5 kg

N. pezzi/Descrizione	Beta N.	TR	N. pezzi/Descrizione	Beta N.	TR
5 chiavi a bussola maschio esagonale 1/2" \odot 5 - 6 - 8 - 10 - 12 mm	920ME	T80	100 rivetti 4,8x12 mm	1741RV...K	T281
1 prolunga - 1/2" 125 mm	920/21	T80	1 pinze regolabili cerniera chiusa 250 mm	1048	T153
1 prolunga - 1/2" 255 mm	920/22	T80	1 pinza autobloccante 240 mm	1052	T153
1 snodo 1/2"	920/25	T80	5 lime a taglio mezzodolce 200 mm	1719BMA8/S	T236
1 quadro maschio 1/2" con spina scorrevole	920/42	T80	1 pinze becchi dritti per anelli elastici, per fori \odot 180 mm	1032	T145
1 cricchetto reversibile 1/2" \oplus	920/55	T80	1 pinze becchi piegati per anelli elastici, per fori \odot 170 mm	1034	T145
19 chiavi a bussola esagonali 1/2" \odot 10+24 - 26 - 27 - 30 - 32 mm	920A	T80	1 pinze becchi dritti per anelli elastici, per alberi \bullet 175 mm	1036	T145
16 chiavi combinate 6+21 mm	42	T15	1 pinze becchi piegati per anelli elastici, per alberi \bullet 175 mm	1038	T145
5 chiavi combinate 22 - 24 - 27 - 30 - 32 mm	42	T16	1 pinza universale \equiv 180 mm	1150BM	T131
13 chiavi a bussola esagonali 1/4" \odot 4+14 mm	900	T91	1 pinza a becchi mezzotondi dritti \bullet 160 mm	1166BM	T131
6 chiavi a bussola maschio esagonale 1/4" \odot 2,5 - 3 - 4 - 5 - 6 - 8 mm	900ME	T91	1 tronchesi a grande effetto taglienti diagonali ∇ 160 mm	1084BM	T131
1 prolunga - 1/4" 50 mm	900/20	T91	5 cacciaspina \varnothing 2 - 3 - 4 - 5 - 6 mm	31	T31
1 prolunga - 1/4" 150 mm	900/21	T91	1 bulino \varnothing 4 mm	32	T31
1 quadro con impugnatura 1/4"	900BG/30	T91	12 chiavi a forchetta 6x7 - 8x9 - 10x11 - 12x13 - 14x15 - 16x17 - 18x19 - 20x22 - 21x23 - 24x26 - 27x29 - 30x32 mm	55	T31
1 snodo 1/4"	900/25	T91	9 chiavi maschio esagonale piegate \odot 1,5 - 2 - 2,5 - 3 - 4 - 5 - 6 - 8 - 10 mm	96N/SC9	T31
1 quadro scorrevole 1/4"	900/42	T91	1 cesoia a lame larghe diritte 250 mm	1112	T285
1 cricchetto reversibile 1/4" \oplus	900/55	T91	1 forbici per elettricisti lame dritte	1128BM	T285
6 chiavi a T maschio esagonale \odot 2,5 - 3 - 4 - 5 - 6 - 8 mm	951	T68	1 seghetto	1726	T285
12 chiavi poligonali curve 6x7-8x9-10x11-12x13-14x15-16x17-18x19 mm	90	T40	5 lame per seghetti	1728BM	T285
5 chiavi poligonali curve 20x22 - 21x23 - 24x26 - 25x28 - 27x29 mm	90	T41	1 oliatore in plastica a pressione 200 cc	1753	T285
7 giravite lama piatta \bullet 2,5x50 - 3x75 - 3,5x100 - 4x125 - 5,5x100 - 5,5x150 - 6,5x150 - 8x150 mm	1260	T199	1 termoformato vuoto	VP5	VP5
6 giravite per viti con impronta a croce Phillips® \oplus PH0x60 - PH0x100 - PH1x80 - PH1x120 - PH2x100 - PH2x150 mm	1262	T202	1 giramaschi regolabile M3÷M12	435/1,5	T273
3 giravite lama piatta \bullet 8x200 - 10x150 - 10x200 mm	1260	T201	1 giramaschi regolabile M5÷M21	435/3	T273
2 giravite nano lama piatta \bullet 4x30 - 6,5x30 mm	1260N	T201	1 giramaschi a cricchetto reversibile 2,0÷5,0 mm (M3÷M8)	436/1	T273
2 giravite per viti con impronta a croce Phillips® \oplus PH3x150 - PH4x200 mm	1262	T204	1 giramaschi a cricchetto reversibile 4,6÷8,0 mm (M5÷M12)	436/2	T273
2 giraviti nano Phillips® \oplus PH1x30 - PH2x30 mm	1262N	T204	1 girafiliera 25,4 mm	444/1	T273
2 scalpelli piatti nervati 100 - 200 mm	35	T234	1 girafiliera 38,1 mm	444/2	T273
1 martello tipo tedesco 300 g	1370	T234	1 contafilletti 0,25÷6 W 62÷4x1"	1707	T273
1 mazzuola con battenti in materiale plastico \varnothing 35 mm	1390	T234	26 maschi a mano passo grosso M3 - 4 - 5 - 6 - 7 - 8 - 9 - 10 - 12 - 14 - 16 - 18 - 20	430	T270
1 rivettatrice 250 mm	1741B	T281	14 maschi a mano passo fine M6x0,75 - M8x1 - M10x1,25 - M12x1,5 - M14x1,5 - M16x1,5 - M18x1,5	433	T270
100 rivetti 2,9x6 mm	1741RV...K	T281	7 filiere tonde passo grosso M3 - 4 - 5 - 6 - 7 - 8 - 9	440	T270
100 rivetti 3,2x8 mm	1741RV...K	T281	6 filiere tonde passo grosso M10 - 12 - 14 - 16 - 18 - 20	440A	T270
100 rivetti 3,8x10 mm	1741RV...K	T281	2 filiere tonde passo fine M6x0,75 - M8x0,75	441	T270
100 rivetti 4x12 mm	1741RV...K	T281	5 filiere tonde passo fine M10x1,25 - M12x1,5 - M14x1,5 - M16x1,5 - M18x1,5	441A	T270

5908VI/2T 2.320,00 059080105

2800 GM/2T 4.150,00 028000325

2800 OM/2T 4.150,00 028000324

2800 RM/2T 4.150,00 028000326

Manutenzioni industriali



N. pezzi/Descrizione

- 16 chiavi combinate 6÷21 mm
- 5 chiavi combinate 22 - 24 - 27 - 30 - 32 mm
- 5 cacciapina Ø 2 - 3 - 4 - 5 - 6 mm
- 1 bulino Ø 4 mm
- 12 chiavi a forchetta 6x7 - 8x9 - 10x11 - 12x13 - 14x15 - 16x17 - 18x19 - 20x22 - 21x23 - 24x26 - 27x29 - 30x32 mm
- 9 chiavi maschio esagonale piegate Ø 1,5 - 2 - 2,5 - 3 - 4 - 5 - 6 - 8 - 10 mm
- 5 chiavi poligonali curve 20x22 - 21x23 - 24x26 - 25x28 - 27x29 mm
- 7 chiavi poligonali curve 6x7 - 8x9 - 10x11 - 12x13 - 14x15 - 16x17 - 18x19 mm
- 5 chiavi a bussola maschio esagonale 1/2" Ø 5 - 6 - 8 - 10 - 12 mm
- 1 prolunga - 1/2" 125 mm
- 1 prolunga - 1/2" 255 mm
- 1 snodo 1/2"
- 1 quadro maschio 1/2" con spina scorrevole
- 1 cricchetto reversibile 1/2"
- 19 chiavi a bussola esagonali 1/2" Ø 10÷24 - 26 - 27 - 30 - 32 mm
- 9 giravite lama piatta ● 3x75 - 3x100 - 4x100 - 4x150 - 5,5x100 - 5,5x150 - 6,5x150 - 8x150 - 10x200 mm
- 2 giravite nano lama piatta ● 4x30 - 6,5x30 mm
- 7 giravite per viti con impronta a croce Phillips® ● PH0x60 - PH0x100 - PH1x80 - PH1x120 - PH2x100 - PH2x150 - PH3x150 mm
- 2 giraviti nano Phillips® ● PH1x30 - PH2x30 mm
- 4 chiavi maschio esagonale piegate Ø 13-14-17-19 mm
- 1 cesoia a lame larghe diritte 250 mm
- 1 forbici per elettricisti lame dritte
- 1 seghetto
- (5) lame per seghetti
- 1 oliatore in plastica a pressione 200 cc
- 1 pinza universale = 180 mm
- 1 pinza a becchi mezzotondi dritti ● 160 mm
- 1 tronchese a grande effetto taglienti diagonali 1/2 160 mm
- 1 pinze becchi dritti per anelli elastici, per fori Ø 180 mm
- 1 pinze becchi piegati per anelli elastici, per fori Ø 170 mm

Beta N.	TR
42	T15
42	T16
31	T31
32	T31
55	T31
96N/SC9	T31
90	T41
90	T40
920ME	T80
920/21	T80
920/22	T80
920/25	T80
920/42	T80
920/55	T80
920A	T80
1260	T167
1260N	T167
1262	T168
1262N	T168
96N	T168
1112	T285
1128BM	T285
1726	T285
1728BM	T285
1753	T285
1150BM	T131
1166BM	T131
1084BM	T131
1032	T145
1034	T145

N. pezzi/Descrizione

- 1 pinze becchi dritti per anelli elastici, per alberi ● 175mm
- 1 pinze becchi piegati per anelli elastici, per alberi ● 175mm
- 2 scalpelli piatti nervati 100 - 200 mm
- 1 martello tipo tedesco 300 g
- 1 mazzuola con battenti in materiale plastico Ø 35 mm
- 1 lime a taglio mezzodolce 200 mm
- 4 chiavi combinate 35-36-38-41 mm
- 1 chiavi a forchetta 36x41 mm
- 1 chiave regolabile a rullino 250 mm
- 1 giratubi modello americano 300 mm
- 25 punte elicoidali cilindriche, serie corta
- 37 assortimento di maschi e filiere in acciaio HSS
- 1 chiave dinamometrica a scatto 200 Nm
- 16 assortimento di 12 chiavi a bussola e 5 accessori 3/4"
- 14 chiavi a T maschio esagonale
- 5 chiavi a T con maschio esagonale snodato Ø 3-4-5-6-8 mm
- 1 pinze becchi dritti per anelli elastici, per fori Ø 300 mm
- 1 pinze becchi piegati per anelli elastici, per fori Ø 290 mm
- 1 pinze becchi dritti per anelli elastici, per alberi ● 225 mm
- 1 pinze becchi piegati per anelli elastici, per alberi ● 220 mm
- 1 pinze regolabili cerniera chiusa 300 mm
- 1 pinza autobloccante a doppia regolazione
- 1 tronchese doppia leva taglio frontale 1/2 180 mm
- 1 martello tipo tedesco 600 g
- 1 mazzuola con battenti in materiale plastico 60 mm
- 5 estrattori conici M3-M18
- 1 estrattore universale a due griffe
- 1 calibro a corsoio
- 1 riga semirigida
- 1 punta per tracciare
- 1 flessometro 5 m
- 1 spessimetro
- 1 flessibile magnetico

Beta N.	TR
1036	T145
1038	T145
35	T234
1370	T234
1390	T234
1719BMA8/	T236
42	
55	
111	
362	
412/SP25	
447/C37	
606/20	
928A/C12	
951/S14	
953	
1032	
1034	
1036	
1038	
1048	
1051	
1092V	
1370	
1390	
1430/S5	
1500/3	
1650	
1683	
1688	
1692	
1708/13	
1712E/2	

5910VI/3T

€ 4.110,00 059100062



3000S/VI3T (C30S+5910VI/3T)

€ 7.010,00 030000093

Manutenzioni industriali



22,5 kg

N. pezzi/Descrizione

- 5 cacciapina Ø 2 - 3 - 4 - 5 - 6 mm
- 1 bulino Ø 4 mm
- 2 scalpelli piatti nervati 200 - 250 mm
- 18 chiavi combinate 6÷14 - 16 - 17 - 18 - 19
21 - 22 - 24 - 27 - 30 mm
- 12 chiavi a forchetta 6x7 - 8x9 - 10x11 - 12x13 - 14x15 - 16x17
18x19 - 20x22 - 21x23 - 24x26 - 27x29 - 30x32 mm
- 12 chiavi maschio esagonale piegate Ø 2÷10 mm
- 1 chiave regolabile a rullino 250 mm
- 1 giratubi svedese 320 mm
- 20 chiavi a bussola poligonali 1/2"
Ø 10÷24 - 26 - 27 - 28 - 30 - 32 mm
- 6 chiavi a bussola maschio esagonale 1/2"
Ø 5 - 6 - 8 - 10 - 12 - 14 mm
- 1 prolunga - 1/2" 125 mm
- 1 prolunga - 1/2" 255 mm
- 1 snodo 1/2"
- 1 quadro maschio a T snodato 1/2"
- 1 quadro maschio 1/2" con spina scorrevole
- 1 cricchetto reversibile 1/2"
- 6 chiavi a T maschio esagonale
Ø 2,5 - 3 - 4 - 5 - 6 - 8 mm
- 2 pinze becchi diritti per anelli elastici,
per fori Ø 140 - 180 mm
- 1 pinze becchi piegati per anelli elastici,
per fori Ø 170 mm
- 2 pinze becchi diritti per anelli elastici,
per alberi ● 140x1,3 - 175 mm
- 1 pinze becchi piegati per anelli elastici,
per alberi ● 175 mm

Beta N.

- 31
- 32
- 35
- 42
- 55
- 96/SC12
- 111
- 374
- 920B
- 920ME
- 920/21
- 920/22
- 920/25
- 920/40
- 920/42
- 920/55
- 951
- 1032
- 1034
- 1036
- 1038

N. pezzi/Descrizione

- 1 pinze regolabili cerniera chiusa 240 mm
- 1 pinza autobloccante 240 mm
- 1 tronchesi a grande effetto taglianti diagonali \angle 160 mm
- 1 tronchesi doppia leva taglio frontale \angle 180 mm
- 1 cesoia a lame larghe diritte 250 mm
- 1 forbici per elettricisti lame diritte
- 1 pinza universale \equiv 180 mm
- 1 pinza a becchi mezzotondi diritti ● 160 mm
- 1 giravite cercafase ●
- 7 giravite lama piatta ● 3,5X100 - 4x100 - 5,5x100 - 6,5X150 - 8X150
-10X200 - 12x250 mm
- 2 giravite nano lama piatta
● 4x30 - 6,5x30 mm
- 5 giravite per viti con impronta a croce Phillips® \oplus PH0x100 - PH1x120 -
PH2x150 - PH3x150 - PH4X200 mm
- 2 giraviti nano Phillips®
 \oplus PH1x30 - PH2x30 mm
- 2 martello tipo tedesco 300 - 500 g
- 1 mazzuola con battenti in materiale plastico Ø 45 mm
- 1 flessibile magnetico 0,5 kg
- 5 lime a taglio mezzodolce 200 mm
- 1 seghetto
- 1 oliatore in plastica a pressione 250 cc

Beta N.

- 1048
- 1052
- 1084BM
- 1092V
- 1112
- 1128BMX
- 1150BM
- 1166BM
- 1253
- 1260
- 1260N
- 1262
- 1262N
- 1370
- 1390
- 1712E/1
- 1719BMA8/
- 1726BM
- 1754

5953VI

1.575,00 059530075

5300VI
(C53VI+5953VI)

2.335,00 053000015

5954VI

assortimento di 115 utensili

Manutenzioni industriali



17 kg

N. pezzi/Descrizione

- 2 punzoni Ø 2 - 3 mm
- 5 cacciaspina Ø 2 - 3 - 4 - 5 - 6 mm
- 1 bulino Ø 4 mm
- 1 scalpelli piatti 150 mm
- 1 ugnetti 150 mm
- 18 chiavi combinate 6+22 - 24 mm
- 12 chiavi a forchetta 6x7 - 8x9 - 10x11 - 12x13 - 14x15 - 16x17 - 18x19 - 20x22 - 21x23 - 24x27 - 25x28 - 30x32 mm
- 12 chiavi maschio esagonale piegate Ø 2÷10 mm
- 1 chiave regolabile a rullino 250 mm
- 20 chiavi a bussola esagonali 1/2" Ø 10÷24 - 26 - 27 - 28 - 30 - 32 mm
- 1 prolunga - 1/2" 125 mm
- 1 prolunga - 1/2" 255 mm
- 1 snodo 1/2"
- 1 quadro maschio 1/2" con spina scorrevole
- 1 cricchetto reversibile 1/2"
- 1 pinze becchi dritti per anelli elastici, per fori Ø 180 mm
- 1 pinze becchi piegati per anelli elastici, per fori Ø 170 mm
- 1 pinze becchi dritti per anelli elastici, per alberi Ø 175 mm
- 1 pinze becchi piegati per anelli elastici, per alberi Ø 175 mm
- 1 pinze regolabili cerniera chiusa 250 mm
- 1 pinza autobloccante 240 mm

Beta N.

- 30
- 31
- 32
- 34
- 36
- 42
- 55/S12X
- 96/SC12
- 111
- 920A
- 920/21
- 920/22
- 920/25
- 920/42
- 920/55
- 1032
- 1034
- 1036
- 1038
- 1048
- 1052

N. pezzi/Descrizione

- 1 tronchesi a taglienti diagonali 160 mm
- 1 cesoia a lame larghe diritte 250 mm
- 1 forbici per elettricisti lame diritte
- 1 pinza universale 180 mm
- 1 pinza a becchi mezzotondi dritti Ø 160 mm
- 1 pinza a becchi mezzotondi piegati Ø 200 mm
- 5 giravite lama piatta Ø 3x75 - 4x125 - 5,5x125 - 6,5x150 - 10x200 mm
- 1 giravite nano lama piatta Ø 4x30 mm
- 3 giravite per viti con impronta a croce Phillips® Ø PH0x60 - PH1x80 - PH2x100 mm
- 1 giraviti nano Phillips® Ø PH1x30 mm
- 1 martello tipo tedesco 400 g
- 1 mazzuola antirimbalzo Ø 35 mm
- 1 estrattore a due griffe oscillanti
- 1 pinza per capicorda preisolati
- 1 flessometro 5 m
- 1 spessimetro
- 1 flessibile magnetico 1,8 kg
- 5 lime a taglio mezzodolce 200 mm
- 1 seghetto
- 1 rivettatrice
- 1 oliatore in plastica a pressione 250 cc

Beta N.

- 1082BM
- 1112
- 1128BMX
- 1150BM
- 1166BM
- 1168BM
- 1260
- 1260N
- 1262
- 1262N
- 1370
- 1392
- 1515/3
- 1602
- 1692
- 1708/20
- 1712E/2
- 1719BMA/S5
- 1726BM
- 1741B
- 1754

5954VI

€ 1.220,00 059540075



5400 GMV (C54VI G+5954VI)

€ 1.890,00 054000152



5400 RMV (C54VI R+5954VI)



5400 OMI (C54VI O+5954VI)

€ 1.890,00 054000154

€ 1.890,00 054000154

Manutenzioni industriali



32 kg

N. pezzi/Descrizione

- 6 cacciaspina Ø 2 - 3 - 4 - 5 - 6 - 8 mm
- 6 2 punzoni, 1 bulino, 3 scalpelli con supporto
- 19 chiavi combinate 6÷22 - 24 - 27 mm
- 12 chiavi poligonali curve 6x7÷30x32 mm
- 12 chiavi maschio esagonale piegate Ø 2÷10 mm
- 1 chiave regolabile a rullino 250 mm
- 13 chiavi a bussola poligonali 1/2" con guida Ø 10÷22 mm
- 8 chiavi a bussola poligonali 1/2" con guida Ø 23÷32 mm
- 4 chiavi a bussola a giravite lama piatta 1/2"
 - 1,2x6,5 - 1,2x8 - 1,6x9 - 2x12 mm
- 3 chiavi a bussola a giravite lama Phillips® 1/2" ⊕ PH2 - 3 - 4
- 1 prolunga - 1/2" 125 mm
- 1 prolunga - 1/2" 255 mm
- 1 snodo 1/2"
- 1 quadro maschio snodato 1/2" con impugnatura
- 1 quadro maschio 1/2" con spina scorrevole
- 1 cricchetto reversibile 1/2" ⊕
- 1 leva con estremità a punta e piatta curva
- 1 pinzetta punta fini curve 130 mm
- 1 pinzetta punta larghe diritte 150 mm
- 1 pinze becchi dritti per anelli elastici, per fori Ø 180 mm
- 1 pinze becchi piegati per anelli elastici, per fori Ø 170 mm
- 1 pinze becchi dritti per anelli elastici, per alberi ● 175 mm
- 1 pinze becchi piegati per anelli elastici, per alberi ● 175 mm
- 1 pinze regolabili cerniera chiusa 250 mm
- 1 pinza autobloccante a doppia regolazione
- 1 tronchesi a grande effetto taglienti diagonali ≤ 160 mm
- 1 tronchesi doppia leva taglio frontale ≤ 180 mm
- 1 cesoia a lame larghe diritte 250 mm
- 1 cesoia a lame strette diritte 250 mm
- 1 forbici per elettricisti lame diritte
- 1 pinza universale = 180 mm
- 1 pinza a becchi mezzotondi dritti ● 160 mm

Beta N.

- 31/SP6
- 38/SP6
- 42
- 90/S12X
- 96/SC12
- 111
- 920B/SB13
- 920B/SB8
- 920LP
- 920PH
- 920/21
- 920/22
- 920/25
- 920/35A
- 920/42
- 920/55
- 963
- 991
- 994
- 1032
- 1034
- 1036
- 1038
- 1048
- 1051
- 1084BM
- 1092V
- 1112
- 1114
- 1128BMX
- 1150BM
- 1166BM

N. pezzi/Descrizione

- 1 pinza a becchi mezzotondi piegati ● 200 mm
- 7 giravite lama piatta ● 3x75 - 3,5x100 - 4x125 - 5,5x150 - 6,5x150 - 10x200 - 12x250 mm
- 1 giravite lama piatta con esagono di manovra ● 12x250 mm
- 3 giravite per viti con impronta a croce Phillips® ⊕ PH0x60 - PH1x80 - PH2x100 mm
- 2 martello tipo tedesco 300 - 600 g
- 1 mazzuola con battenti in materiale plastico Ø 35 mm
- 1 flessometro 5 m
- 1 flessibile magnetico 1,8 kg
- 1 raschietto a due taglienti 200 mm
- 1 raschietto a tre taglienti 200 mm
- 5 lime a taglio mezzodolce 200 mm
- 1 seghetto
- 1 oliatore in metallo a pressione 200 cc
- 2 scalpelli piatti nervati 200 - 250 mm
- 1 ugnetto nervato 200 mm
- 6 chiavi maschio esagonali con impugnatura Ø 2÷6 mm
- 10 chiavi a pipa doppie esagonali - poligonali 8 - 10 - 11 - 13 - 14 - 17 - 19 - 22 - 24 - 27 mm
- 1 pinze becchi dritti per anelli elastici, per fori Ø 140 mm
- 1 pinze becchi piegati per anelli elastici, per fori Ø 130 mm
- 1 pinze becchi dritti per anelli elastici, per alberi ● 140x1,3 mm
- 1 pinze becchi piegati per anelli elastici, per alberi ● 135x1,3 mm
- 1 pinza autobloccante 280 mm
- 1 pinza autobloccante 290 mm
- 1 martello tipo tedesco 1000 g
- 1 mazzuola antirimbalzo Ø 50 mm
- 1 estrattore universale a due griffe 25÷130 mm
- 1 calibro a corsoio
- 1 riga semirigida 300 mm
- 1 punta per tracciare
- 1 spessimetro
- 1 coltello a serramanico

Beta N.

- 1168BM
- 1260
- 1260E
- 1262
- 1370
- 1390
- 1692
- 1712E/2
- 1717A
- 1717B
- 1719BMA/S5
- 1725
- 1751
- 35
- 37
- 96T/S6
- 932
- 1032
- 1034
- 1036
- 1038
- 1060
- 1062
- 1370
- 1392
- 1500N/2
- 1650
- 1683
- 1688A
- 1708/13
- 1777BM

5957VI € 2.325,00 059570027

5700A OVI € 5.540,00 057000196
(C57A O+5957VI)

5700B OVI € 6.140,00 057000198
(C57B O+5957VI)

5700A GVI € 5.540,00 057000396
(C57A G+5957VI)

5700B GVI € 6.140,00 057000398
(C57B G+5957VI)

5700A RVI € 5.540,00 057000598
(C57A R+5957VI)

5700B RVI € 6.140,00 057000598
(C57B R+5957VI)

5904VU/1M

assortimento di 91 utensili in termoformato morbido

Universali



M15 M33 M199 M202



M50 M83



M132 M153 M234 M145

13,5 kg

N. pezzi/Descrizione

- 16 chiavi combinate 6÷21 mm
- 12 chiavi a forchetta 6x7 - 8x9 - 10x11 - 12x13 - 14x15 - 16x17 - 18x19 - 20x22 mm
- 9 chiavi maschio esagonale piegate
 ○ 1,5 - 2 - 2,5 - 3 - 4 - 5 - 6 - 8 - 10 mm
- 7 giravite lama piatta ● 2,5x50 - 3x75 - 3,5x100 - 4x125 - 5,5x100 - 5,5x150 - 6,5x150 mm
- 6 giravite per viti con impronta a croce Phillips® ⚙ PH0x60 - PH0x100 - PH1x80 - PH1x120 - PH2x100 - PH2x150 mm
- 8 chiavi maschio esagonale con impugnatura
 ○ 2-2,5-3-4-5-6-7-8 mm
- 1 prolunga angolare - 1/2" 125 mm
- 1 prolunga angolare - 1/2" 250 mm
- 1 snodo 1/2"
- 1 quadro maschio 1/2" con spina scorrevole
- 1 cricchetto reversibile 1/2" ⚙
- 19 chiavi a bussola esagonali 1/2"
 ○ 10÷24 - 26 - 27 - 30 - 32 mm





Beta N.	TR
42	M15
55	M33
96/SC9	M33
1260	M199
1262	M202
96T	M50
920AN/125	M83
920AN/250	M83
920/25	M83
920/42	M83
920/55	M83
920A	M83



N. pezzi/Descrizione

- 1 tronchesi a grande effetto taglienti diagonali ≤ 160 mm
- 1 pinza universale = 180 mm
- 1 pinza a becchi mezzotondi dritti ● 160 mm
- 1 pinze regolabili cerniera chiusa 250 mm
- 1 pinza autobloccante 240 mm
- 2 scalpelli piatti nervati 100 - 200 mm
- 1 martello tipo tedesco 300 g
- 1 mazzuola con battenti in materiale plastico Ø 35 mm
- 1 pinze becchi dritti per anelli elastici, per fori ○ 180 mm
- 1 pinze becchi piegati per anelli elastici, per fori ○ 170 mm
- 1 pinze becchi dritti per anelli elastici, per alberi ● 175 mm
- 1 pinze becchi piegati per anelli elastici, per alberi ● 175 mm

Beta N.	TR
1084	M132
1150	M132
1166	M132
1048	M153
1052	M153
35	M234
1370	M234
1390	M234
1032	M145
1034	M145
1036	M145
1038	M145

	€	
	939,00	059040201
	1.505,00	024002517
	1.505,00	024002518
	1.505,00	024002519
	1.570,00	024002617

	€	
	1.570,00	024002618
	1.570,00	024002619
	2.100,00	039000117
	2.100,00	039000118
	2.100,00	039000119

	€	
	2.180,00	039000137
	2.180,00	039000138
	2.180,00	039000139

5904VU/2M

assortimento di 152 utensili in termoformato morbido

Universali



M15 M33 M199 M202



M50 M83



M132 M153 M237 M145



M204 M289 M85 M236

20 kg

N. pezzi/Descrizione

- 16 chiavi combinate 6+21 mm
- 12 chiavi a forchetta 6x7 - 8x9 - 10x11 - 12x13 - 14x15 - 16x17 - 18x19 - 20x22 mm
- 9 chiavi maschio esagonale piegate \odot 1,5 - 2 - 2,5 - 3 - 4 - 5 - 6 - 8 - 10 mm
- 7 giravite lama piatta \bullet 2,5x50 - 3x75 - 3,5x100 - 4x125 - 5,5x100 - 5,5x150 - 6,5x150 mm
- 6 giravite per viti con impronta a croce Phillips® \oplus PH0x60 - PH0x100 - PH1x80 - PH1x120 - PH2x100 - PH2x150 mm
- 8 chiavi maschio esagonale con impugnatura \odot 2-2,5-3-4-5-6-7-8 mm
- 1 prolunga angolare - 1/2" 125 mm
- 1 prolunga angolare - 1/2" 250 mm
- 1 snodo 1/2"
- 1 quadro maschio 1/2" con spina scorrevole
- 1 cricchetto reversibile 1/2" \oplus
- 19 chiavi a bussola esagonali 1/2" \odot 10-24 - 26 - 27 - 30 - 32 mm
- 1 tronchesi a grande effetto taglianti diagonali \nlessgtr 160 mm
- 1 pinza universale \equiv 180 mm
- 1 pinza a becchi mezzotondi dritti \bullet 160 mm
- 1 pinze regolabili cerniera chiusa 250 mm
- 1 pinza autobloccante 240 mm
- 2 scalpelli piatti nervati 100 - 200 mm
- 1 martello tipo tedesco 300 g
- 1 mazzuola \emptyset 35 mm

Beta N.	TR
42	M15
55	M33
96/SC9	M33
1260	M199
1262	M202
96T	M50
920AN/125	M83
920AN/250	M83
920/25	M83
920/42	M83
920/55	M83
920A	M83
1084	M132
1150	M132
1166	M132
1048	M153
1052	M153
35	M237
1370T	M237
1390N	M237

N. pezzi/Descrizione

- 1 pinze becchi dritti per anelli elastici, per fori \odot 180 mm
- 1 pinze becchi piegati per anelli elastici, per fori \odot 170 mm
- 1 pinze becchi dritti per anelli elastici, per alberi \bullet 175 mm
- 1 pinze becchi piegati per anelli elastici, per alberi \bullet 175 mm
- 6 chiave maschio per viti con impronta Torx® \odot T8-T10-T15-T20-T25-T30
- 1 flessometro 5 m
- 1 miniseghetto
- 1 oliatore in plastica 30 cc
- 1 cutter con lama a settori
- 5 inserti colorati per avvitatori per viti a testa con intaglio \bullet 0,5x3 - 0,6x4,5 - 0,8x5,5 - 1x5,5 - 1,2x6,5 mm
- 8 inserti colorati maschio esagonale per avvitatori \odot 2 - 2,5 - 3 - 4 - 5 - 6 - 8 - 10 mm
- 5 inserti colorati per avvitatori per viti con impronta a croce Phillips® \oplus PH0 - PH1 - PH2 - PH3 - PH4
- 4 inserti colorati per avvitatori per viti con impronta a croce Pozidriv® \oplus PZ1 - PZ2 - PZ3 - PZ4
- 10 inserti colorati per avvitatori per viti con impronta Torx® \odot T7-T8-T9-T10-T15-T20-T25-T27-T30-T40
- 8 inserti colorati per avvitatori per viti con impronta Tamper Resistant Torx® \oplus T9-T10-T15-T20-T25-T27-T30-T40
- 1 portainseri a sgancio rapido con impugnatura 230 mm
- 1 cricchetto reversibile portainseri 100 mm
- 5 lime a taglio mezzodolce 200 mm

Beta N.	TR
1032	M145
1034	M145
1036	M145
1038	M145
1267TX	M204
1692	M289
1725CR	M289
1755	M289
1771	M289
860LP	M85
860PE	M85
860PH	M85
860PZ	M85
860TX	M85
860RTX	M85
851SR	M85
860/55	M85
1719BMA8/S5	M236

€

€

€



5904VU/2M	1.240,00	059040202
2400S7-O/VU2M (C24S7/O+5904VU/2M)	1.930,00	024002744
2400S7-G/VU2M (C24S7/G+5904VU/2M)	1.930,00	024002745
2400S7-R/VU2M (C24S7/R+5904VU/2M)	1.930,00	024002746
2400SL-O/VU2M (C24SL/O+5904VU/2M)	2.240,00	024002417
2400SL-G/VU2M (C24SL/G+5904VU/2M)	2.240,00	024002418



2400SL-R/VU2M (C24SL/R+5904VU/2M)	2.240,00	024002419
2400SAXL-O/VU2M (C24SA-XL/7 O+5904VU/2M)	2.130,00	024002457
2400SAXL-G/VU2M (C24SA-XL/7 G+5904VU/2M)	2.130,00	024002458
2400SAXL-R/VU2M (C24SA-XL/7 R+5904VU/2M)	2.130,00	024002459
3900 O-7/VU2M (C39 O/7+5904VU/2M)	2.480,00	039000154
3900 G-7/VU2M (C39 G/7+5904VU/2M)	2.480,00	039000155



3900 R-7/VU2M (C39 R/7+5904VU/2M)	2.480,00	039000156
3900 O-8/VU2M (C39 O/8+5904VU/2M)	2.560,00	039000191
3900 G-8/VU2M (C39 G/8+5904VU/2M)	2.560,00	039000192
3900 R-8/VU2M (C39 R/8+5904VU/2M)	2.560,00	039000193

5904VU/3T

assortimento di 146 utensili in termoformato

Universali



T15 T16 T31



T52 T55 T80



T91 T145 T132 T153



T198 T205 T234 T236

23 kg

N. pezzi/Descrizione

- 16 chiavi combinate 6÷21 mm
- 5 chiavi combinate 22 - 24 - 27 - 30 - 32 mm
- 5 cacciapina Ø 2 - 3 - 4 - 5 - 6 mm
- 1 bulino Ø 4 mm
- 12 chiavi a forchetta 6x7 - 8x9 - 10x11 - 12x13 - 14x15 - 16x17 - 18x19 - 20x22 - 21x23 - 24x26 - 27x29 - 30x32 mm
- 9 chiavi maschio esagonale piegate Ø 1,5 - 2 - 2,5 - 3 - 4 - 5 - 6 - 8 - 10 mm
- 6 chiavi maschio esagonale con impugnatura Ø 2 - 2,5 - 3 - 4 - 5 - 6 mm
- 6 chiavi maschio con impugnatura per viti con impronta Torx®
- ⊙ T10-T15-T20-T25-T27-T30
- 5 chiavi a bussola maschio esagonale 1/2"
- ⊙ 5 - 6 - 8 - 10 - 12 mm
- 1 prolunga - 1/2" 125 mm
- 1 prolunga - 1/2" 255 mm
- 1 snodo 1/2"
- 1 quadro maschio 1/2" con spina scorrevole
- 1 cricchetto reversibile 1/2" ⊕
- 19 chiavi a bussola esagonali 1/2"
- ⊙ 10÷24 - 26 - 27 - 30 - 32 mm
- 13 chiavi a bussola esagonali 1/4"
- ⊙ 4-4,5-5-5,5-6-7-8-9-10-11-12-13-14 mm
- 6 chiavi a bussola maschio esagonale 1/4"
- ⊙ 2,5-3-4-5-6-8 mm
- 1 prolunga - 1/4" 50 mm
- 1 prolunga - 1/4" 150 mm
- 1 snodo 1/4"
- 1 quadro con impugnatura 1/4"

Beta N.	TR
42	T15
42	T16
31	T31
32	T31
55	T31
96N/SC9	T31
96T	T52
97TTX	T55
920ME	T80
920/21	T80
920/22	T80
920/25	T80
920/42	T80
920/55	T80
920A	T80
900	T91
900ME	T91
900/20	T91
900/21	T91
900/25	T91
900BG/30	T91

N. pezzi/Descrizione

- 1 quadro scorrevole 1/4" 115 mm
- 1 cricchetto reversibile 1/4" ⊕
- 1 pinze becchi dritti per anelli elastici, per fori ⊙ 180 mm
- 1 pinze becchi piegati per anelli elastici, per fori ⊙ 170 mm
- 1 pinze becchi dritti per anelli elastici, per alberi ● 175 mm
- 1 pinze becchi piegati per anelli elastici, per alberi ● 175 mm
- 1 pinza universale = 180 mm
- 1 pinza a becchi mezzotondi dritti ● 160 mm
- 1 tronchesi a grande effetto taglienti diagonali ⚡ 160 mm
- 1 pinze regolabili cerniera chiusa 250 mm
- 1 pinza autobloccante 240 mm
- 4 giravite lama piatta ● 3x75 - 4x100 - 5,5x150 - 6,5x150 mm
- 3 giravite per viti con impronta a croce Pozidriv®-Supadriv®
- ⊕ PZ0 - PZ1 - PZ2
- 7 chiave maschio per viti con impronta Torx®
- ⊙ T6-T7-T8-T9-T10-T15-T20
- 2 scalpelli piatti nervati 100 - 200 mm
- 1 martello tipo tedesco 300 g
- 1 mazzuola con battenti in materiale plastico Ø 35 mm
- 5 lime a taglio mezzodolce 200 mm

Beta N.	TR
900/42	T91
900/55	T91
1032	T145
1034	T145
1036	T145
1038	T145
1150	T132
1166	T132
1084	T132
1048	T153
1052	T153
1260	T198
1269PZ	T198
1267TX	T205
35	T234
1370	T234
1390	T234
1719BMA8/S5	T236

	€	
5904VU/3T	1.445,00	059040203
2400S7-OVU/3T (C24S7/O+5904VU/3T)	2.135,00	024002747
2400S7-GVU/3T (C24S7/G+5904VU/3T)	2.135,00	024002748
2400S7-RVU/3T (C24S7/R+5904VU/3T)	2.135,00	024002749

	€	
2400SA7-OVU/3T (C24SA7/O+5904VU/3T)	2.185,00	024002757
2400SA7-GVU/3T (C24SA7/G+5904VU/3T)	2.185,00	024002758
2400SA7-RVU/3T (C24SA7/R+5904VU/3T)	2.185,00	024002759
3900 O-7VU/3T (C39 O/7+5904VU/3T)	2.680,00	039000157

	€	
3900 G-7VU/3T (C39 G/7+5904VU/3T)	2.680,00	039000158
3900 R-7VU/3T (C39 R/7+5904VU/3T)	2.680,00	039000159

5915VU/0

assortimento di 35 utensili

Universali



4,3 kg

N. pezzi/Descrizione

- 1 bulino 4 mm
- 1 scalpelli piatti nervati 125 mm
- 8 chiavi a forchetta 6x7-8x9-10x11-12x13-14x15-16x17-18x19-20x22 mm
- 7 chiavi maschio esagonale \varnothing 1,5-2-2,5-3-4-5-6 mm
- 1 chiave regolabile a rullino 150 mm
- 1 pinze regolabili cerniera chiusa 250 mm
- 1 tronchesi a taglienti diagonali ∇ 160 mm
- 1 forbici per elettricisti lame dritte
- 1 pinza universale \equiv 180 mm

Beta N.

- 32
- 35
- 55
- 96/BGS7
- 111
- 1048
- 1082
- 1128BMX
- 1150

N. pezzi/Descrizione

- 1 pinza a becchi mezzotondi diritti \bullet 160 mm
- 4 giravite lama piatta \bullet 3x75-4x100-5,5x100-6,5x150 mm
- 3 giravite Phillips® \oplus PH0x60-PH1x80-PH2x100 mm
- 1 martello tipo tedesco 300 g
- 1 flessometro 3 m
- 1 cutter con lama a settori 18 mm
- 1 coltello soccorso auto
- 1 torcia LED 90 Lumen

Beta N.

- 1166
- 1201
- 1202
- 1370
- 1692/3
- 1771
- 1778SOS
- 1834S

5915VU/0

€ 295,00  059150120



2105VU/0

(C5+5915VU/0)

376,00 021050120



2106TVU/0

(C6T+5915VU/0)

438,00 021060120

5915VU/1

assortimento di 45 utensili

Universali



5 kg

N. pezzi/Descrizione

2	punzoni Ø 2-3 mm	Beta N.	30
1	bulino Ø 4 mm		32
2	scalpelli piatti 125-150 mm		34
1	ugnetti 150 mm		36
14	chiavi combinate 6÷14 - 17 - 19 - 21 - 22 - 24 mm		42
9	chiavi maschio esagonale piegate 1,5 - 2 - 2,5 - 3 - 4 - 5 - 6 - 8 - 10 mm	96/SC9	
1	chiave regolabile a rullino 250 mm		111
1	pinze regolabili cerniera chiusa 250 mm		1048
1	tronchesi a taglienti diagonali 160 mm		1082
1	forbici per elettricisti lame diritte		1128BMX

N. pezzi/Descrizione

1	pinza universale 180 mm	Beta N.	1150
1	pinza a becchi mezzotondi diritti 160 mm		1166
4	giravite lama piatta 3x75 - 4x100 - 5,5x100 - 6,5x150 mm		1201
3	giravite Phillips® PH0x60 - PH1x80 - PH2x100 mm		1202
1	martello tipo tedesco 300 g		1370
1	flessometro 5 m		1692
1	cutter con lama a settori		1771

	5915VU/1	€ 363,00		059150124		2115LVU/1 (C15L+5915VU/1)	€ 402,00		021150131		2110SVU/1 (C10S+5915VU/1)	€ 439,00		021100101
	2109VU/1 (C9+5915VU/1)	€ 438,00		021090021		2117PVU/1 (CP17+5915VU/1)	€ 421,00		021170041		2111VU/1 (C11+5915VU/1)	€ 421,00		021110101
	2110VU/1 (C10+5915VU/1)	€ 461,00		021100021		2117PLVU/1 (CP17L+5915VU/1)	€ 446,00		021170141		2116VU/1 (C16+5915VU/1)	€ 436,00		021160101
	2115VU/1 (C15+5915VU/1)	€ 394,00		021150031		2118VU/1 (C18+5915VU/1)	€ 393,00		021180031					

5915VU/2

assortimento di 49 utensili

Universali



4,6 kg

N. pezzi/Descrizione

- 8 chiavi a forchetta 6x7 - 8x9 - 10x11 - 12x13 - 14x15
16x17 - 18x19 - 20x22 mm
- 9 chiavi maschio esagonale piegate
Ø 1,5 - 2 - 2,5 - 3 - 4 - 5 - 6 - 8 - 10 mm
- 13 chiavi a bussola esagonali 1/4"
Ø 4 - 4,5 - 5 - 5,5 - 6 - 7 - 8 - 9 - 10 - 11 - 12 - 13 - 14 mm
- 1 prolunga - 1/4" 150 mm
- 1 snodo 1/4"
- 1 quadro con impugnatura 1/4"
- 1 quadro scorrevole 1/4"
- 1 cricchetto reversibile 1/4" ®
- 1 pinze regolabili cerniera chiusa 250 mm

Beta N.

- 55/B8
- 96/SC9
- 900
- 900/21
- 900/25
- 900BG/30
- 900/42
- 900/55
- 1048

N. pezzi/Descrizione

- 1 forbici per elettricisti lame diritte
- 1 pinza universale = 180 mm
- 4 giravite lama piatta
● 3x75 - 4x100 - 5,5x150 - 6,5x150 mm
- 3 giravite Phillips®
⊕ PH0x60 - PH1x80 - PH2x100 mm
- 1 martello tipo tedesco 300 g
- 1 flessometro 3 m
- 1 oliatore in plastica 30 cc
- 1 cutter con lama a settori 18 mm

Beta N.

- 1128BMX
- 1150
- 1201
- 1202
- 1370
- 1692
- 1755
- 1771

5915VU/2 € 309,00 059150127

2120LVU/2 (C20L+5915VU/2)

368,00 021200116

2034VU/2 (2034VV+5915VU/2)

564,00 020340106

2120VU/2 (C20+5915VU/2) € 363,00 021200016

2014NVU/2 (2014NVV+5915VU/2)

489,00 020140020

5915VU/3

assortimento di 75 utensili

Universali



8,1 kg

N. pezzi/Descrizione

- 1 cacciaspina Ø 4 mm
- 1 bulino Ø 4 mm
- 1 scalpelli piatti 150 mm
- 15 chiavi combinate 6÷17 - 19 - 22 - 24 mm
- 9 chiavi maschio esagonale piegate \odot 1,5÷10 mm
- 3 chiavi maschio esagonale con impugnatura \odot 4 - 5 - 6 mm
- 1 chiave regolabile a rullino 250 mm
- 13 chiavi a bussola esagonali 1/2" \odot 8÷17 - 19 - 22 - 24 mm
- 1 prolunga - 1/2" 255 mm
- 1 snodo 1/2"
- 1 quadro maschio 1/2" con spina scorrevole
- 1 cricchetto reversibile 1/2" \otimes
- 7 chiavi a tubo doppie serie leggera 6x7 - 8x9 - 10x11 - 12x13 - 14x15 - 16x17 - 18x19 mm
- 2 spine di manovra per chiavi a tubo 1 - 2
- 1 pinze regolabili cerniera chiusa 250 mm

Beta N.

- 31
- 32
- 34
- 42
- 96/SC9
- 96T
- 111
- 920A
- 920/22
- 920/25
- 920/42
- 920/55
- 935
- 940
- 1048V

N. pezzi/Descrizione

- 1 pinza autobloccante 240 mm
- 1 tronchesi a grande effetto taglianti diagonali ∇ 160 mm
- 1 forbici per elettricisti lame dritte
- 1 pinza universale \equiv 180 mm
- 1 pinza a becchi mezzotondi dritti \bullet 160 mm
- 4 giravite lama piatta \bullet 3x75 - 4x100 - 5,5x150 - 6,5x150 mm
- 3 giravite Phillips® \oplus PH0x60 - PH1x80 - PH2x100 mm
- 1 martello tipo tedesco 400 g
- 1 flessometro 5 m
- 1 seghetto
- 1 oliatore in plastica 150 cc
- 1 cutter con lama a settori

Beta N.

- 1052
- 1084BM
- 1128BMX
- 1150BM
- 1166BM
- 1201
- 1202
- 1370
- 1692
- 1726
- 1755
- 1771

	€			€			€			
5915VU/3	699,00	059150126		2117PLVU/3 (CP17L+5915VU/3)	782,00	021170143		4100H/VU/3 (C41H+5915VU/3)	1.094,00	041000093
2109VU/3 (C9+5915VU/3)	774,00	021090123		2119VU/3 (C19+5915VU/3)	738,00	021190023		2110SVU/3 (C10S+5915VU/3)	775,00	021100103
2110VU/3 (C10+5915VU/3)	797,00	021100023		2119LVU/3 (C19L+5915VU/3)	748,00	021190123		2111VU/3 (C11+5915VU/3)	757,00	021110103
2115VU/3 (C15+5915VU/3)	730,00	021150033		2120VU/3 (C20+5915VU/3)	753,00	021200017		2116VU/3 (C16+5915VU/3)	772,00	021160103
2115LVU/3 (C15L+5915VU/3)	738,00	021150133		2120LVU/3 (C20L+5915VU/3)	758,00	021200117				
2117PVU/3 (CP17+5915VU/3)	757,00	021170043		4100S/VU/3 (C41S+5915VU/3)	1.044,00	041000083				

5915VU/4

assortimento di 80 utensili

Universali



11,2 kg

N. pezzi/Descrizione

- 1 cacciapina Ø 4 mm
- 1 bulino Ø 4 mm
- 1 scalpelli piatti 150 mm
- 15 chiavi combinate 6÷17 - 19 - 22 - 24 mm
- 9 chiavi maschio esagonale piegate \odot 1,5÷10 mm
- 1 chiave regolabile a rullino 250 mm
- 13 chiavi a bussola esagonali 1/2" \odot 8÷17 - 19 - 22 - 24 mm
- 1 prolunga - 1/2" 255 mm
- 1 snodo 1/2"
- 1 quadro maschio 1/2" con spina scorrevole
- 1 cricchetto reversibile 1/2" \otimes
- 17 chiavi a pipa doppie esagonali - poligonali 6÷22 mm
- 1 pinze regolabili cerniera chiusa 250 mm
- 1 pinza autobloccante 240 mm

Beta N. N. pezzi/Descrizione

- 31
- 32
- 34
- 42
- 96/SC9
- 111
- 920A
- 920/22
- 920/25
- 920/42
- 920/55
- 932/S17
- 1048
- 1052
- 1 tronchesi a grande effetto taglienti diagonali \nlessgtr 160 mm
- 1 forbici per elettricisti lame diritte
- 1 pinza universale \equiv 180 mm
- 1 pinza a becchi mezzotondi diritti \bullet 160 mm
- 4 giravite lama piatta \bullet 3x75 - 4x100 - 5,5x150 - 6,5x150 mm
- 3 giravite Phillips \oplus PH0x60 - PH1x80 - PH2x100 mm
- 1 martello tipo francese 32 mm
- 1 flessometro 5 m
- 1 seghetto
- 1 oliatore in plastica 150 cc
- 1 cutter con lama a settori

Beta N.

- 1084BM
- 1128BMX
- 1150BM
- 1166BM
- 1201
- 1202
- 1370F
- 1692
- 1726
- 1755
- 1771

5915VU/4

€ 886,00 059150145

2120VU/4

(C20+5915VU/4)

940,00 021200018

2120LVU/4

(C20L+5915VU/4)

945,00 021200118

5915VU/AS

assortimento di 71 utensili

Universali



9,3 kg

N. pezzi/Descrizione

- 1 cacciaspina Ø 4 mm
- 1 bulino Ø 4 mm
- 1 scalpelli piatti 150 mm
- 13 chiavi combinate 1/4 - 5/16 - 3/8 - 7/16 - 1/2 - 9/16 - 5/8 - 11/16 - 3/4 - 13/16 - 7/8 - 15/16 - 1"
- 8 chiavi poligonali curve 1/4"÷1"
- 11 chiavi maschio esagonale piegate ○ 3/64"÷3/8"
- 1 chiave regolabile a rullino 250 mm
- 13 chiavi a bussola poligonali □ 1/2" ○ 3/8 - 7/16 - 1/2 - 9/16 - 5/8 - 19/32 - 11/16 - 3/4 - 25/32 - 13/16 - 7/8 - 15/16 - 1"
- 1 prolunga - 1/2" 255 mm
- 1 snodo 1/2"
- 1 quadro maschio 1/2" con spina scorrevole
- 1 cricchetto con quadro scorrevole 1/2" ⊕
- 1 pinze regolabili cerniera chiusa 250 mm
- 1 pinza autobloccante 240 mm

Beta N.

- 31
- 32
- 34
- 42AS
- 90AS/8
- 96AS/B11
- 111
- 920AS
- 920/22
- 920/25
- 920/42
- 920/50
- 1048V
- 1052

N. pezzi/Descrizione

- 1 tronchesi a grande effetto taglianti diagonali 160 mm
- 1 forbici per elettricisti lame diritte
- 1 pinza universale 180 mm
- 1 pinza a becchi mezzotondi diritti 160 mm
- 4 giravite lama piatta 3x75 - 4x100 - 5,5x150 - 6,5x150 mm
- 3 giravite Phillips PH0x60 - PH1x80 - PH2x100 mm
- 1 martello tipo tedesco 400 g
- 1 flessometro 5 m
- 1 seghetto
- 1 oliatore in plastica 150 cc
- 1 cutter con lama a settori

Beta N.

- 1084BM
- 1128BMX
- 1150BM
- 1166BM
- 1201
- 1202
- 1370
- 1692
- 1726
- 1755
- 1771

5915VU/AS

€ 723,00 059150131



2120VU/AS
(C20+5915VU/AS)

€ 777,00 021200019



2120LVU/AS
(C20L+5915VU/AS)

€ 782,00 021200119



2110VU/AS
(C10+5915VU/AS)

€ 821,00 021100025

5923VU/1T

assortimento di 86 utensili in termoformato morbido per C22S, C23S, C23SC

Universali



MC10

MC82



MC91

MC220



MC153

MC131

10 kg

N. pezzi/Descrizione

- 16 chiavi combinate 6÷21 mm
- 19 chiavi a bussola esagonali 1/2"
 - 10+24 - 26 - 27 -30 -32 mm
- 1 snodo 1/2"
- 1 prolunga angolare - 1/2" 125 mm
- 1 quadro maschio 1/2" con spina scorrevole
- 1 cricchetto reversibile 1/2" ⊕
- 13 chiavi a bussola esagonali 1/4" ○ 4÷14 mm
- 6 chiavi a bussola maschio esagonale 1/4" ○ 2,5-3-4-5-6-8 mm
- 1 prolunga - 1/4" 50 mm
- 1 prolunga - 1/4" 150 mm
- 1 snodo 1/4"
- 1 quadro con impugnatura 1/4"
- 1 quadro scorrevole 1/4"

- | | |
|-----------|-------------|
| Beta N. | TR |
| 42 | MC10 |
| 920A | MC82 |
| 920/25 | MC82 |
| 920AN/125 | MC82 |
| 920/42 | MC82 |
| 920/55 | MC82 |
| 900 | MC91 |
| 900ME | MC91 |
| 900/20 | MC91 |
| 900/21 | MC91 |
| 900/25 | MC91 |
| 900BG/30 | MC91 |
| 900/42 | MC91 |

N. pezzi/Descrizione

- | | | |
|--|--------|--------------|
| 1 cricchetto reversibile 1/4" ⊕ | 900/55 | MC91 |
| 4 giravite lama piatta ● 3x75 - 4x100 - 5,5x150 - 6,5x150 mm | 1201 | MC220 |
| 3 giravite Phillips® ⊕ PH0x60 - PH1x80 - PH2x100 mm | 1202 | MC220 |
| 9 chiavi maschio esagonale piegate | 96/SC9 | MC153 |
| ○ 1,5 - 2 - 2,5 - 3 - 4 - 5 - 6 - 8 - 10 mm | | |
| 1 pinze regolabili cerniera chiusa 240 mm | 1048 | MC153 |
| 1 martello tipo tedesco 300 g | 1370 | MC153 |
| 1 flessometro 5m | 1692 | MC153 |
| 1 tronchesi a grande effetto taglienti diagonali ✂ 160 mm | 1084BM | MC131 |
| 1 pinza universale = 180 mm | 1150BM | MC131 |
| 1 pinza a becchi mezzotondi dritti ● 160 mm | 1166BM | MC131 |

5923VU/1T € 761,00 059230102

2200S-OVU1T € 1.086,00 022000451
(C22S-O+5923VU/1T)

2200S-GVU1T € 1.086,00 022000452
(C22S-G+5923VU/1T)

2200S-RVU1T € 1.086,00 022000453
(C22S-R+5923VU/1T)

2300S-OVU1T € 1.161,00 023000441
(C23S-O+5923VU/1T)

2300S-GVU1T € 1.161,00 023000442
(C23S-G+5923VU/1T)

2300S-RVU1T € 1.161,00 023000443
(C23S-R+5923VU/1T)

2300SC-OVU1T € 1.205,00 023000611
(C23SC O+5923VU/1T)

2300SC-GVU1T € 1.205,00 023000612
(C23SC G+5923VU/1T)

2300SC-RVU1T € 1.205,00 023000613
(C23SC R+5923VU/1T)

Universali

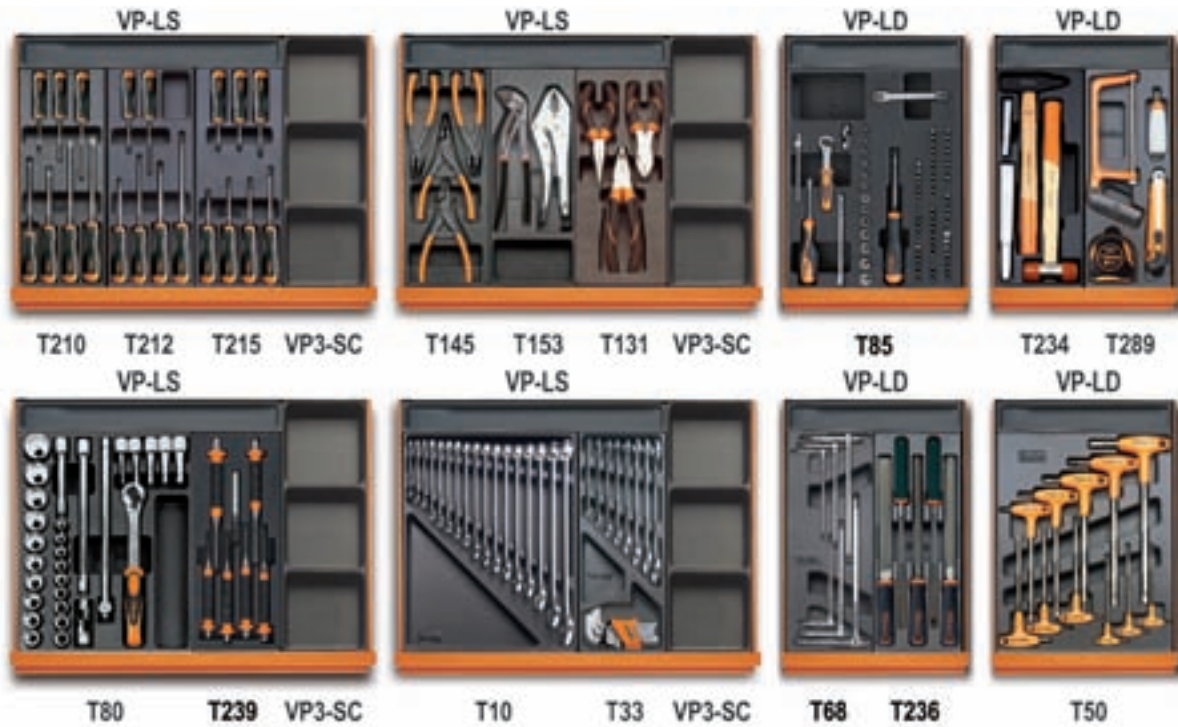

23,5 kg

N. pezzi/Descrizione

N. pezzi/Descrizione	Beta N.	TR
7 giravite lama piatta ● 2,5x50 - 3x75 - 3,5x100 - 4x125	1201	T210
5,5x100 - 5,5x150 - 6,5x150 mm		
6 giravite Phillips® ● PH0x60-PH1x80-PH1x120-PH2x100-PH2x150-PH3x150 mm	1202	T212
7 chiavi maschio con impugnatura per viti con impronta Torx® ● T6-T7-T8-T9-T10-T15-T20	1207TX	T215
1 pinze becchi dritti per anelli elastici, per fori ○ 180 mm	1032	T145
1 pinze becchi piegati per anelli elastici, per fori ○ 170 mm	1034	T145
1 pinze becchi dritti per anelli elastici, per alberi ● 175 mm	1036	T145
1 pinze becchi piegati per anelli elastici, per alberi ● 175 mm	1038	T145
1 pinze regolabili cerniera chiusa 240 mm	1048	T153
1 pinza autobloccante 240 mm	1052	T153
1 tronchesi a grande effetto taglienti diagonali ✂ 160 mm	1084BM	T131
1 pinza universale = 180 mm	1150BM	T131
1 pinza a becchi mezzotondi dritti ● 160 mm	1166BM	T131
1 chiave portainseri a cricchetto reversibile 1/4x5/16	194	T85
13 chiavi a bussola esagonali 1/4" ○ 4-4,5-5-5,5-6-7-8-9-10-11-12-13-14 mm	900	T85
1 cricchetto reversibile 1/4" ● 125 mm	900/55	T85
1 quadro scorrevole 1/4" 115 mm	900/42	T85
1 quadro con impugnatura 1/4" 176 mm	900BG/30	T85
1 snodo 1/4" 41 mm	900/25	T85
1 prolunga - 1/4" 150 mm	900/21	T85
1 portainseri a sgancio rapido con impugnatura 230 mm	851SR	T85
5 inserti per avvitatori per viti con impronta Spanner ● 4-6-8-10-12 mm	861SP	T85
8 inserti per avvitatori per viti con impronta Torq-Set® ● 0-1-2-3-4-5-6-8 mm	861TQS	T85
6 inserti per avvitatori per viti con impronta Tri-Wing® ● 1-2-3-4-5-6 mm	861TRW	T85
8 inserti per avvitatori per viti con impronta Tamper Resistant Torx® ● T9-T10-T15-T20-T25-T27-T30-T40	861RTX	T85
11 inserti per avvitatori per viti con impronta Torx® ● T6-T7-T8-T9-T10-T15-T20-T25-T27-T30-T40	861TX	T85
3 inserti per avvitatori per viti con impronta a croce Pozidriv® - Supadriv® ● PZ1 - PZ2 - PZ3	861PZ	T85

N. pezzi/Descrizione

N. pezzi/Descrizione	Beta N.	TR
4 inserti per avvitatori per viti con impronta a croce Phillips® ● PH0 - PH1 - PH2 - PH3	861PH	T85
8 inserti maschio esagonale per avvitatori ○ 2 - 2,5 - 3 - 4 - 5 - 6 - 8 - 10 mm	861PE	T85
7 inserti per avvitatori per viti a testa con intaglio ● 0,5x3 - 0,6x4,5 - 0,8x5,5 - 1x5,5 - 1,2x6,5 - 1,2x8 - 1,6x8 mm	861LP	T85
2 scalpelli piatti nervati 100 - 200 mm	35	T234
1 martello tipo tedesco 300 g	1370	T234
1 mazzuola con battenti in materiale plastico Ø 35 mm	1390	T234
1 flessometro 5 m	1692	T289
1 miniseghetto	1725CR	T289
1 oliatore in plastica	1755	T289
1 cutter con lama a settori	1771	T289
19 chiavi a bussola esagonali 1/2" ○ 10 - 11 - 12÷19 - 20 - 21 - 22 - 23 - 24 - 26 - 27 - 30 - 32 mm	920A	T80
5 chiavi a bussola maschio esagonale 1/2" ○ 5 - 6 - 8 - 10 - 12 mm	920ME	T80
1 prolunga - 1/2" 125 mm	920/21	T80
1 prolunga - 1/2" 255 mm	920/22	T80
1 snodo 1/2"	920/25	T80
1 quadro maschio 1/2" con spina scorrevole	920/42	T80
1 cricchetto reversibile 1/2" ●	920/55	T80
1 bulino Ø 4 mm	32	T239
6 cacciaspina con impugnatura 2-3-4-5-6-8 mm	31BM	T239
17 chiavi combinate 6-7-8-10-11-12-13-14-16-17-18-19-21-22-24-27-30 mm	42	T10
8 chiavi a forchetta 6x7 - 8x9 - 10x11 - 12x13 - 14x15 - 16x17 - 18x19 - 20x22 mm	55	T33
9 chiavi maschio esagonale piegate ○	96/SC9	T33
6 chiavi a T maschio esagonale ○ 2,5 - 3 - 4 - 5 - 6 - 8 mm	951	T68
5 lime a taglio mezzodolce 200 mm	1719BMA8/S5	T236
11 chiavi maschio esagonale con impugnatura ○ 2 - 2,5 - 3 - 3,5 - 4 - 4,5 - 5 - 6 mm	96T	T50
4 termoformati vuoti	VP-3SC	VP-3SC
4 termoformati vuoti	VP-LS	VP-LS
4 termoformati vuoti	VP-LD	VP-LD

€

5938U/2T 1.720,00 059380062

€

3800 G/U2T 2.930,00 038000069
(C38 G+5938U/2T)

3800 O/U2T 2.930,00 038000068
(C38 O+5938U/2T)

3800 R/U2T 2.930,00 038000070
(C38 R+5938U/2T)

Universali



21,3 kg

N. pezzi/Descrizione

- 6 cacciaspina Ø 2 - 3 - 4 - 5 - 6 - 8 mm
- 6 2 punzoni, 1 bulino, 3 scalpelli con supporto
- 19 chiavi combinate 6÷22 - 24 - 27 mm
- 12 chiavi poligonali curve 6x7+30x32 mm
- 12 chiavi maschio esagonale piegate Ø 2÷10 mm
- 1 chiave regolabile a rullino 250 mm
- 13 chiavi a bussola poligonali 1/2" con guida
○ 10÷22 mm
- 8 chiavi a bussola poligonali 1/2" con guida
○ 23÷32 mm
- 4 chiavi a bussola a giravite lama piatta 1/2"
● 1,2x6,5 - 1,2x8 - 1,6x9 - 2x12 mm
- 3 chiavi a bussola a giravite lama Phillips® 1/2"
⊕ PH2 - 3 - 4
- 1 prolunga - 1/2" 125 mm
- 1 prolunga - 1/2" 255 mm
- 1 snodo 1/2"
- 1 quadro maschio snodato 1/2" con impugnatura
- 1 quadro maschio 1/2" con spina scorrevole
- 1 cricchetto reversibile 1/2" Ⓢ
- 1 leva con estremità a punta e piatta curva
- 1 pinzetta punte fini curve 130 mm
- 1 pinzetta punte larghe diritte 150 mm
- 1 pinze becchi diritti per anelli elastici,
per fori ○ 180 mm
- 1 pinze becchi piegati per anelli elastici,
per fori ○ 170 mm
- 1 pinze becchi diritti per anelli elastici,
per alberi ● 175 mm
- 1 pinze becchi piegati per anelli elastici, per alberi ● 175 mm

Beta N.

- 31/SP6
- 38/SP6
- 42
- 90/S12X
- 96/SC12
- 111
- 920B/SB13
- 920B/SB8
- 920LP
- 920PH
- 920/21
- 920/22
- 920/25
- 920/35A
- 920/42
- 920/55
- 963
- 991
- 994
- 1032
- 1034
- 1036
- 1038

N. pezzi/Descrizione

- 1 pinze regolabili cerniera chiusa 250 mm
- 1 pinza autobloccante a doppia regolazione
- 1 tronchesi a grande effetto taglienti diagonali < 160 mm
- 1 tronchesi doppia leva taglio frontale < 180 mm
- 1 cesoia a lame larghe diritte 250 mm
- 1 cesoia a lame strette diritte 250 mm
- 1 forbici per elettricisti lame diritte
- 1 pinza universale = 180 mm
- 1 pinza a becchi mezzotondi diritti ● 160 mm
- 1 pinza a becchi mezzotondi piegati ● 200 mm
- 7 giravite lama piatta ● 3x75 - 3,5x100 - 4x125
5,5x150 - 6,5x150 - 10x200 - 12x250 mm
- 1 giravite lama piatta con esagono di manovra ● 12x250 mm
- 3 giravite per viti con impronta a croce Phillips®
⊕ PH0x60 - PH1x80 - PH2x100 mm
- 2 martello tipo tedesco 300 - 600 g
- 1 mazzuola con battenti in materiale plastico Ø 35 mm
- 1 flessometro 5 m
- 1 flessibile magnetico 1,8 kg
- 1 raschietto a due taglienti 200 mm
- 1 raschietto a tre taglienti 200 mm
- 5 lime a taglio mezzodolce 200 mm
- 1 seghetto
- 1 oliatore in metallo a pressione 200 cc

Beta N.

- 1048
- 1051
- 1084BM
- 1092V
- 1112
- 1114
- 1128BMX
- 1150BM
- 1166BM
- 1168BM
- 1260
- 1260E
- 1262
- 1370
- 1390
- 1692
- 1712E/2
- 1717A
- 1717B
- 1719BMA/S5
- 1725
- 1751

5957U

€ 1.635,00

059570026

5700P GU

(C57P G+5957U)

€ 2.870,00

057000395

5700P OU

(C57P O+5957U)

€ 2.870,00

057000195

5700P RU

(C57P R+5957U)

€ 2.870,00

057000595

Universali



11,3 kg

N. pezzi/Descrizione

- 18 chiavi combinate 5,5÷22 mm
- 12 chiavi maschio esagonale piegate \varnothing 2÷10 mm
- 13 chiavi a bussola esagonali 1/2" con guida \varnothing 10÷22 mm
- 8 chiavi a bussola esagonali 1/2" con guida \varnothing 23÷32 mm
- 1 prolunga - 1/2" 125 mm
- 1 prolunga - 1/2" 255 mm
- 1 snodo 1/2"
- 1 quadro maschio 1/2" con spina scorrevole
- 1 cricchetto reversibile 1/2" \otimes
- 1 pinze becchi dritti per anelli elastici, per fori \varnothing 180 mm
- 1 pinze becchi dritti per anelli elastici, per alberi \bullet 175 mm
- 1 pinze regolabili cerniera chiusa 250 mm
- 1 pinza autobloccante 240 mm
- 1 tronchesi a grande effetto taglienti diagonali \nlessgtr 160 mm
- 1 forbici per elettricisti lame diritte
- 1 pinza universale \equiv 180 mm

Beta N.

- 42
- 96N/SC12
- 920A/SB13
- 920A/SB8
- 920/21
- 920/22
- 920/25
- 920/42
- 920/55
- 1032
- 1036
- 1048
- 1052
- 1084BM
- 1128BMX
- 1150BM

N. pezzi/Descrizione

- 1 pinza a becchi mezzotondi dritti \bullet 160 mm
- 7 giravite lama piatta \bullet 3x75 - 3,5x100 - 4x125 - 5,5x150 - 6,5x150 - 8x200 - 10x200 mm
- 4 giravite Phillips® \oplus PH0x60 - PH1x80 - PH2x100 - PH3x150 mm
- 1 martello tipo tedesco 300 g
- 1 mazzuola con battenti in materiale plastico \varnothing 35 mm
- 1 flessometro 5 m
- 5 lime a taglio mezzodolce 200 mm
- 1 seghetto
- 1 oliatore in plastica a pressione 150 cc
- 1 cutter con lama a settori

Beta N.

- 1166BM
- 1260
- 1262/S4
- 1370
- 1390
- 1692
- 1719BMA/S5
- 1725
- 1754
- 1771

5958U

€ 876,00 059580024



5800B/U
(C58B+5958U)

€ 2.750,00 058000192



5800P/BU
(C58P/B+5958U)

€ 1.735,00 058000197



5800A/U
(C58A+5958U)

€ 2.195,00 058000191



5800P/AU
(C58P/A+5958U)

€ 1.176,00 058000196

5980ET/A

assortimento di 60 utensili

Elettrotecnica



7,9 kg

N. pezzi/Descrizione

- 2 cacciaspina Ø 4 - 6 mm
- 1 bulino Ø 4 mm
- 2 scalpelli piatti nervati 125 - 200 mm
- 8 chiavi a forchetta 6x7 - 8x9 - 10x11 - 12x13 - 14x15 - 16x17 - 18x19 - 20x22 mm
- 10 chiavi maschio esagonale piegate Ø 1,5+12 mm
- 1 chiave regolabile a rullino 200 mm
- 1 pinza regolabile a cerniera chiusa, impugnatura bimatereale 250 mm
- 1 tronchesi a taglienti diagonali 160 mm
- 1 forbici per elettricisti lame diritte con svasatore
- 1 tagliacavo 170 mm
- 1 pinza spellafili 160 mm
- 1 pinza universale 180 mm
- 1 pinza a becchi mezzotondi diritti 160 mm
- 1 pinza a becchi mezzotondi piegati 160 mm
- 1 giravite prensile lama piatta 4x125 mm
- 1 giravite prensile Phillips® PH1x150 mm

Beta N.

- 31
- 32
- 35
- 55/B8
- 96/B10
- 111
- 1048BM
- 1082BM
- 1128BSX
- 1132BM
- 1142BM
- 1150BM
- 1166BM
- 1168BM
- 1250
- 1251

N. pezzi/Descrizione

- 1 giravite cercafase
- 4 giravite lama piatta 2,5x75 - 3,5x100 - 5,5x125 - 6,5x150 mm
- 1 giravite nano lama piatta 4x30 mm
- 2 giraviti nano Phillips® PH2x30 - PH1x30 mm
- 4 giravite Phillips® 1000V PH0x60 - PH1x80 - PH2x100 - PH3x150 mm
- 5 giravite lama parallela 1000V 5,5x125 - 3x100 - 4x100 - 6,5x150 - 8x175 mm
- 1 martello tipo tedesco 300 g
- 1 mazzuola con battenti in materiale plastico Ø 35 mm
- 1 pinza per capicorda preisolati
- 1 nastro isolante 25 m
- 1 flessometro 5 m
- 1 200 mm
- 1 lime a taglio mezzodolce 200 mm
- 1 seghetto
- 1 coltello a serramanico

Beta N.

- 1253
- 1260
- 1260N
- 1262N
- 1272MQ
- 1274MQ
- 1370
- 1390
- 1602
- 1639NS-N
- 1692
- 1719BMA/M
- 1719BMA/R
- 1725
- 1777BM

€

5980ET/A 622,00 059800261



2011ET/A 897,00 020110127
(2011/BV+5980ET/A)



2032ET/A 832,00 020320117
(2032/VV+5980ET/A)



€

2034ET/A 877,00 020340114
(2034/VV+5980ET/A)

2032TET/A 920,00 020320227
(2032/TV+5980ET/A)

5980ET/B

assortimento di 64 utensili e 200 collari

Elettrotecnica



8,7 kg

N. pezzi/Descrizione

3	cacciaspina Ø 2 - 3 - 4 mm	Beta N.	31
1	bulino Ø 4 mm		32
1	scalpelli piatti 150 mm		34
8	chiavi a forchetta 6x7 - 8x9 - 10x11 - 12x13 14x15 - 16x17 - 18x19 - 20x22 mm		55/B8
9	chiavi maschio esagonale piegate con estremità sferica Ø 1,5 - 2 - 2,5 - 3 - 4 - 5 - 6 - 8 - 10 mm	96BPC/SC9	
1	sbavatore a raschietto 150 mm		345SB
6	chiavi a bussola esagonale con impugnatura 1000V Ø 5,5 - 6 - 7 - 8 - 10 - 13 mm	943MQ/S6	
1	pinze regolabili a cerniera chiusa 250 mm		1048MQ
1	tronchesi a taglienti diagonali 1000V 160 mm		1082MQ
1	forbici per elettricisti lame diritte con svasatore		1128BSX
1	tagliacavi 230 mm		1132MQ
1	pinze spellafili 160 mm		1142MQ
1	pinza universale 1000V 180 mm		1150MQ
1	pinze a becchi mezzotondi lunghissimi 1000V 160 mm		1166MQ
1	giravite cercafase		1253
3	giravite Phillips® 1000V PH0x60 - PH1x80 - PH2x100 mm		1272MQ
4	giravite lama parallela 1000V 3x100 - 4x100 - 5,5x125 - 6,5x150 mm		1274MQ

N. pezzi/Descrizione

1	martello tipo tedesco 300 g	Beta N.	1370
1	mazzuola con battenti in materiale plastico Ø 35 mm		1390
1	pinza per capicorda preisolati		1602
1	riga flessibile graduata 250 mm		1682
1	punta per tracciare 250 mm		1688
1	flessometro 5 m		1692
1	livella in alluminio 200 mm		1696
1	scalpello per elettricisti 10x200 mm		1701NE/3
1	traccialinea		1705
1	specchietto flessibile 600 mm		1715FL/A
1	200 mm		1719BMA/M
1	lime a taglio mezzodolce 200 mm		1719BMA/R
1	tenditore per molle		1723
1	seghetto		1726BM
1	pennello		1738
1	pinza per collari in Nylon		1743
1	oliatore in plastica 80 cc		1755
100	collari in Nylon 3,6x200 mm		1748/8K
100	collari in Nylon 4,8x300 mm		1748/17K
1	cutter con lama a settori		1771BM
1	saldatore 30 W		1814M
1	torcia LED		1835/2

5980ET/B € **916,00** 059800263

2029ET/B € **1.156,00** 020290221
 (2029/VV+5980ET/B)

2033ET/B € **1.310,00** 020330117
 (2033N/VV+5980ET/B)

2036ET/B € **1.285,00** 020360123
 (2036/TV+5980ET/B)

elettrotecnica



7 kg

N. pezzi/Descrizione

- 7 chiavi a forchetta 1000V
10 - 12 - 13 - 14 - 17 - 19 - 22 mm
- 1 chiave regolabile a rullino 1000V 250 mm
- 6 chiavi a bussola esagonale con impugnatura
○ 5,5 - 6 - 7 - 8 - 10 - 13 mm
- 4 chiavi a T maschio esagonale
○ 4 - 5 - 6 - 8 mm
- 1 pinzetta a molla a punte curve arrotondate 1000V 147 mm
- 1 pinze a becchi tondi lunghi 160 mm
- 1 pinze regolabili a cerniera chiusa
- 1 tronchesi a taglianti diagonali 1000V 160 mm
- 1 forbici per elettricisti
- 1 pinze spellafili 160 mm
- 1 pinza universale 1000V 180 mm
- 1 pinze a becchi mezzotondi lunghissimi 1000V 160 mm

Beta N.

- 52MQ
- 110MQ
- 943MQ
- 951MQ
- 993MQ
- 1010MQ
- 1048MQ
- 1082MQ
- 1127MQ
- 1142MQ
- 1150MQ
- 1166MQ

N. pezzi/Descrizione

- 1 giravite cercafase
- 4 giravite Phillips® 1000V
➤ PH0x60 - PH1x80 - PH2x100 - PH3x150 mm
- 5 giravite lama parallela 1000V
● 3x100 - 4x100 - 5,5x125 - 6,5x150 - 8x175 mm
- 3 giravite Pozidrive® 1000V
➤ PZ0 - PZ1 - PZ2
- 1 mazzuola con battenti in materiale plastico Ø 35 mm
- 1 specchietto
- 1 miniseghetto 1000V
- 1 cutter 1000V
- 1 saldatore 30 W
- 1 pompetta succhiastagno
- 1 tester combinato di tensione e di continuità

- Beta N.
- 1253
- 1272MQ
- 1274MQ
- 1279MQ
- 1390
- 1714
- 1725MQ
- 1777MQ
- 1814M
- 1830T
- 1847P

€

5980/MQ 1.147,00 059800254

2029BG/MQ 1.385,00 020290261
(2029VV+5980BG/MQ)

5980EL/A

assortimento di 57 utensili

Electronica



2,6 kg

N. pezzi/Descrizione

- 13 chiavi a forchetta piccole 4+14 mm
- 9 chiavi maschio esagonale piegate \odot 1,5+10 mm
- 1 pinzetta punte fini curve 130 mm
- 1 pinzetta punte fini diritte 150 mm
- 1 pinzetta becchi diritti incrociati 155 mm
- 1 forbici per elettricisti lame diritte con svasatore
- 1 pinza spellafili \downarrow 160 mm
- 1 pinza a becchi mezzotondi diritti \bullet 160 mm
- 1 pinza a becchi piatti lunghi \equiv
- 1 pinza a becchi mezzotondi lunghi piegati \bullet
- 1 pinza universale per elettronica \bullet
- 1 tronchese a taglienti diagonali rasi \downarrow
- 1 tronchese a taglienti diagonali normali \downarrow
- 1 giravite prensile lama piatta \bullet 4x125 mm

Beta N.

- 73/B13
- 96N/SC9
- 991
- 992
- 998
- 1128BSX
- 1142BM
- 1166BM
- 1172BM
- 1178BM/P
- 1178BM
- 1185BM
- 1188BM
- 1250

N. pezzi/Descrizione

- 1 giravite prensile Phillips® \oplus PH0x125 mm
- 8 microgiraviti
- 1 martello tipo tedesco 200 g
- 1 flessometro 5 m
- 1 specchietto telescopico
- 3 lime ad ago
- 1 tenditore per molle
- 1 pennello
- 1 oliatore a stilo
- 1 cutter con lama a settori
- 1 pinzetta autobloccante
- 1 saldatore 25 W
- 1 pompetta succhiastagno
- 1 torcia LED

Beta N.

- 1251
- 1257LPH/S8
- 1370
- 1692
- 1715
- 1720/S3
- 1723
- 1738
- 1756
- 1771
- 1779
- 1814M
- 1830T
- 1835/2

5980EL/1

€ 666,00 059800239



2034EL/A
(2034/NV+5980EL/A)

€ 921,00 020340107



2032EL/A
(2032/NV+5980EL/A)

€ 876,00 020320108



2032T EL/A
(2032/TV+5980EL/A)

€ 964,00 020320208

5980EL/B

assortimento di 98 utensili

Elettronica



4,8 kg

N. pezzi/Descrizione

- 13 chiavi a forchetta piccole 4+14 mm
- 9 chiavi maschio esagonale piegate \odot 1,5+10 mm
- 8 chiavi maschio con impronta Torx®
- \odot T9 - T10 - T15 - T20 - T25 - T27 - T30 - T40
- 1 chiave regolabile a rullino 150 mm
- 18 assortimento 13 bussole e 5 accessori 1/4"
- 1 pinzetta a molla a punte fini diritte 130 mm
- 1 pinzetta punte fini curve 120 mm
- 1 pinzetta a molla a punte corte finissime 120 mm
- 1 forbici per elettricisti lame diritte
- 1 pinza spellafili frontale autoregolabile 170 mm
- 1 pinza universale \equiv 180 mm
- 1 pinza a becchi piatti lunghi \equiv 140 mm
- 1 pinza a becchi mezzotondi lunghi lisci \bullet 140 mm
- 1 pinza a becchi mezzotondi lunghi piegati \bullet 140 mm
- 1 tronchese a taglienti diagonali rasi becchi arrotondati ζ 120 mm
- 1 tronchese a taglienti diagonali rasi becchi assotigliati ζ 120 mm
- 1 tronchese a taglienti frontali obliqui rasi ζ
- 8 microgiraviti
- 1 giravite cercafase \bullet

Beta N.

- 73/B13
- 96/SC9
- 97TX/BG8
- 111
- 900/C13-5
- 990
- 991
- 999A
- 1128BMX
- 1149F
- 1150BM
- 1172BM
- 1177BM
- 1178BM/P
- 1184BM
- 1186BM
- 1191BM
- 1257LPH/S8
- 1253

N. pezzi/Descrizione

- 1 giravite nano lama piatta \bullet 6,5x30 mm
- 3 giravite Phillips® \oplus PH0x60 - PH1x80 - PH2x100 mm
- 2 giravite nano Phillips® \oplus PH1x30 - PH2x30 mm
- 5 giravite lama parallela \bullet 2,5x60 - 3x75 - 4x100 - 5x125 - 6,5x150 mm
- 1 martello tipo tedesco 200 g
- 1 riga flessibile graduata 150 mm
- 1 punta per tracciare 220 mm
- 1 flessometro 5 m
- 1 specchietto telescopico 670 mm
- 1 lime ad ago \bullet
- 1 lime ad ago \blacktriangle
- 1 lime ad ago \blacksquare
- 1 tenditore per molle
- 1 pennello
- 1 oliatore a stilo
- 1 cutter con lama a settori
- 1 coltello a serramanico
- 1 pinzetta autobloccante
- 1 saldatore 25W
- 1 pompetta succhiastagno
- 1 torcia LED

Beta N.

- 1290N
- 1292
- 1292N
- 1294
- 1370
- 1682
- 1688
- 1692
- 1715
- 1720R
- 1720T
- 1720P
- 1723
- 1738
- 1756
- 1771BM
- 1777BM
- 1779
- 1814M
- 1830T
- 1835/2

5980EL/B

€ 933,00 059800240



2033EL/B
(2033NV+5980EL/B)

€ 1.330,00 020330105

2029EL/B

€ 1.173,00 020290216



(2029NV+5980EL/B)

2036EL/B
(2036TV+5980EL/B)

€ 1.305,00 020360117



5980ID

assortimento di 35 utensili

Idraulica**11,6 kg****N. pezzi/Descrizione**

- 1 scalpelli piatti 150 mm
- 1 scalpelli piatti nervati 200 mm
- 12 chiavi a forchetta 6x7 - 8x9 - 10x11 - 12x13 - 14x15 - 16x17 - 18x19 - 20x22 - 21x23 - 24x27 - 25x28 - 30x32 mm
- 1 chiave regolabile a rullino 250 mm
- 1 tagliatubi per rame e leghe leggere Ø 3÷30 mm
- 1 giratubi svedese 320 mm
- 1 pinze regolabili cerniera chiusa 250 mm
- 1 pinza autobloccante 240 mm
- 1 cesoia a lame larghe diritte 300 mm
- 1 forbici per elettricisti lame diritte
- 1 pinza universale = 180 mm

Beta N.

- 34
- 35
- 55/S12X
- 111
- 334
- 374
- 1048
- 1052
- 1112
- 1128BMX
- 1150BM

N. pezzi/Descrizione

- 4 giravite lama piatta
- 3x75 - 4x100 - 5,5x150 - 8x150 mm
- 2 giravite Phillips®
- ⊕ PH1x80 - PH2x100 mm
- 1 martello tipo tedesco 300 g
- 1 metro pieghevole in fibra 2 m
- 1 flessometro 5 m
- 1 livella in alluminio 200 mm
- 1 lime a taglio mezzodolce 200 mm
- 1 seghetto
- 1 spazzola fili d'acciaio

Beta N.

- 1201
- 1202
- 1370
- 1690F
- 1692
- 1696A
- 1719BMA/M
- 1725
- 1737NX

5980ID€ **423,00** 059800321**2009ID**
(2009N/BV+5980ID)**605,00** 020090012

5902MT

assortimento di 106 utensili per macchine agricole, edili e movimento terra

Autoriparazione



28,6 kg

N. pezzi/Descrizione

- 2 punzoni Ø 3 - 4 mm
- 2 cacciaspina Ø 6 - 8 mm
- 1 bulino Ø 4 mm
- 2 scalpelli piatti nervati 150 - 200 mm
- 18 chiavi combinate 6÷14 - 17 - 19 - 22 - 24
27 - 30 - 32 - 36 - 41 mm
- 10 chiavi poligonali curve 6x7 - 8x9 - 10x11 - 12x13 - 14x15 - 16x17 -
18x19 - 20x22 - 24x27 - 30x32 mm
- 10 chiavi maschio esagonale piegate \odot 1,5÷12 mm
- 17 chiavi a bussola esagonali 1/2"
 \odot 10÷22 - 24 - 27 - 30 - 32 mm
- 1 prolunga - 1/2" 125 mm
- 1 prolunga - 1/2" 255 mm
- 1 snodo 1/2"
- 1 quadro maschio 1/2" con spina scorrevole
- 1 cricchetto con quadro scorrevole 1/2" \otimes
- 11 chiavi a bussola esagonali 3/4"
 \odot 22 - 24 - 27 - 30 - 32 - 36 - 41 - 46 - 50 - 55 - 60 mm
- 1 prolunga - 3/4" 200 mm
- 1 quadro maschio snodato 3/4" con impugnatura
- 1 quadro maschio 3/4" con spina scorrevole

Beta N.

- 30
- 31
- 32
- 35
- 42
- 90
- 96N/B10
- 920A
- 920/21
- 920/22
- 920/25
- 920/42
- 920/50
- 928A
- 928/21
- 928/36A
- 928/42

N. pezzi/Descrizione

- 1 cricchetto reversibile 3/4" \otimes 928/55
- 1 leva con estremità a punta e a becco 964
- 1 pinze regolabili cerniera chiusa 250 mm 1048
- 1 pinza autobloccante ganasce sagomate 1055
- 1 tronchesi a grande effetto taglienti diagonali ∇ 160 mm 1084BM
- 1 forbici per elettricisti lame diritte 1128BMX
- 1 pinza universale \equiv 180 mm 1150BM
- 1 pinza a becchi mezzotondi dritti \bullet 160 mm 1166BM
- 4 giravite lama piatta con esagono di manovra 1260E
- \bullet 6,5x150 - 8x175 - 10x200 - 12x250 mm
- 3 giravite Phillips® con esagono di manovra 1262E
- \oplus PH2x150 - PH3x175 - PH4x200 mm
- 1 martello testa tonda penna sferica 900 g 1377
- 1 mazzuola con battenti in materiale plastico Ø 35 mm 1390
- 1 spessimetro 1708/20
- 1 raschietto a tre taglienti 200 mm 1717B
- 5 lime a taglio mezzodolce 200 mm 1719BMA/S5
- 1 seghetto 1725

5902MT

€ 1.610,00  059020043



2200S-O/MT
(C22S-O+5902MT)

€ 1.935,00 022000431



2200S-G/MT
(C22S-G+5902MT)

€ 1.935,00 022000432



2200S-R/MT
(C22S-R+5902MT)

€ 1.935,00 022000433



2300S-O/MT
(C23S-O+5902MT)

€ 2.010,00  023000461



2300S-G/MT
(C23S-G+5902MT)

€ 2.010,00 023000462



2300S-R/MT
(C23S-R+5902MT)

€ 2.010,00 023000463



2300SC-O/MT
(C23SC O+5902MT)

€ 2.055,00 023000491



2300SC-G/MT
(C23SC G+5902MT)

€ 2.055,00  023000492



2300SC-R/MT
(C23SC R+5902MT)

€ 2.055,00 023000493

5902MT/AS

assortimento di 99 utensili per macchine movimento terra (CATERPILLAR)

Autoriparazione



27,3 kg

N. pezzi/Descrizione

2	punzoni Ø 3 - 4 mm
2	cacciaspina Ø 6 - 8 mm
1	bulino Ø 4 mm
2	scalpelli piatti nervati 150 - 200 mm
20	chiavi combinate 1/4÷1.1/2"
6	chiavi poligonali curve 1/4x5/16 - 3/8x7/16 - 1/2x9/16 5/8x3/4 - 11/16x13/16 - 7/8x15/16"
11	chiavi maschio esagonale piegate ○ 3/64÷3/8"
10	chiavi a bussola poligonali □ 1/2" ○ 7/16 - 1/2 - 9/16 5/8 - 11/16 - 3/4 - 13/16 - 7/8 - 15/16 - 1"
1	prolunga - 1/2" 125 mm
1	prolunga - 1/2" 255 mm
1	snodo 1/2"
1	quadro maschio 1/2" con spina scorrevole
1	cricchetto con quadro scorrevole 1/2" Ⓢ
12	chiavi a bussola esagonali ○ □ 3/4", 7/8 - 15/16 - 1 - 1.1/16 - 1.1/8 - 1.1/4 - 1.5/16 1.1/2 - 1.5/8 - 1.11/16 - 1.7/8 - 2"
1	prolunga - 3/4" 200 mm
1	quadro maschio snodato 3/4" con impugnatura
1	quadro maschio 3/4" con spina scorrevole

Beta N.

30
31
32
35
42AS
90AS
96AS/B11
920AS
920/21
920/22
920/25
920/42
920/50
928AS
928/21
928/36A
928/42

N. pezzi/Descrizione

1	cricchetto reversibile 3/4" Ⓢ
1	leva con estremità a punta e a becco
1	pinze regolabili cerniera chiusa 250 mm
1	pinza autobloccante ganasce sagomate
1	tronchesi a grande effetto taglienti diagonali ⚡ 160 mm
1	forbici per elettricisti lame diritte
1	pinza universale = 180 mm
1	pinza a becchi mezzotondi dritti ● 160 mm
4	giravite lama piatta con esagono di manovra ● 6,5x150 - 8x175 - 10x200 - 12x250 mm
3	giravite Phillips® con esagono di manovra ● PH2x150 - PH3x175 - PH4x200 mm
1	martello testa tonda penna sferica 900 g
1	mazzuola con battenti in materiale plastico Ø 35 mm
1	spessimetro 150 - 200 mm
1	raschietto a tre taglienti 200 mm
5	lime a taglio mezzodolce 200 mm
1	seghetto

Beta N.

928/55
964
1048
1055
1084BM
1128BMX
1150BM
1166BM
1260E
1262E
1377
1390
1708/20
1717B
1719BMA/S5
1725

5902MT/AS

€ 1.660,00  059020044



2200S-R/MTAS

(C22S-R+5902MT/AS)

€ 1.985,00  022000443



2300S-OMT/AS

(C23S-O+5902MT/AS)

€ 2.060,00  023000471



2300S-G/MTAS

(C23S-G+5902MT/AS)

€ 2.060,00  023000472



2300S-R/MTAS

(C23S-R+5902MT/AS)

€ 2.060,00  023000473



2200S-O/MTAS

(C22S-O+5902MT/AS)

€ 1.985,00  022000441



2200S-G/MTAS

(C22S-G+5902MT/AS)

€ 1.985,00  022000442

5904VG/1M

assortimento di 76 utensili in termoformato morbido

Autoriparazione



M15

M16

M132



M50

M55

M220



M83

M145

M234

13,5 kg

N. pezzi/Descrizione

- 16 chiavi combinate 6+21 mm
- 5 chiavi combinate 22 - 24 - 27 - 30 - 32 mm
- 1 tronchesi a grande effetto taglienti diagonali \angle 160 mm
- 1 pinza universale \equiv 180 mm
- 1 pinza a becchi mezzotondi dritti \bullet 160 mm
- 8 chiavi maschio esagonale con impugnatura \circ 2-2,5-3-4-5-6-7-8 mm
- 6 chiavi maschio con impugnatura per viti con impronta Torx® \circ T10-T15-T20-T25-T27-T30
- 4 giravite lama piatta \bullet 3x75 - 4x100 - 5,5x150 - 6,5x150 mm
- 3 giravite Phillips® \circ PH0x60 - PH1x80 - PH2x100 mm
- 1 prolunga angolare - 1/2" 125 mm
- 1 prolunga angolare - 1/2" 250 mm
- 1 snodo 1/2"

Beta N.	TR
42	M15
42	M16
1084	M132
1150	M132
1166	M132
96T	M50
97TTX	M55
1201	M220
1202	M220
920AN/125	M83
920AN/250	M83
920/25	M83

N. pezzi/Descrizione

- 1 quadro maschio 1/2" con spina scorrevole
- 1 cricchetto reversibile 1/2" \circ
- 19 chiavi a bussola esagonali 1/2" \circ 10+24 - 26 - 27 - 30 - 32 mm
- 1 pinze becchi dritti per anelli elastici, per fori \circ 180 mm
- 1 pinze becchi piegati per anelli elastici, per fori \circ 170 mm
- 1 pinze becchi dritti per anelli elastici, per alberi \bullet 175 mm
- 1 pinze becchi piegati per anelli elastici, per alberi \bullet 175 mm
- 2 scalpelli piatti nervati 100 - 200 mm
- 1 martello tipo tedesco 300 g
- 1 mazzuola con battenti in materiale plastico \varnothing 35 mm

Beta N.	TR
920/42	M83
920/55	M83
920A	M83
1032	M145
1034	M145
1036	M145
1038	M145
35	M234
1370	M234
1390	M234

	€	
5904VG/1M	935,00	059040197
2300ST-O-VG/1M (C23ST O+5904VG/1M)	1.405,00	023000685
2300ST-G-VG/1M (C23ST G+5904VG/1M)	1.405,00	023000686
2300ST-R-VG/1M (C23ST R+5904VG/1M)	1.405,00	023000687
2400S7-O-VG/1M (C24S7 O+5904VG/1M)	1.625,00	024002741

	€	
2400S7-G-VG/1M (C24S7 G+5904VG/1M)	1.625,00	024002742
2400S7-R-VG/1M (C24S7 R+5904VG/1M)	1.625,00	024002743
2400SA7-O-VG/1M (C24SA7 O+5904VG/1M)	1.675,00	024002754
2400SA7-G-VG/1M (C24SA7 G+5904VG/1M)	1.675,00	024002755
2400SA7-R-VG/1M (C24SA7 R+5904VG/1M)	1.675,00	024002756

	€	
3900 O-7-VG/1M (C39 O7+5904VG/1M)	2.175,00	039000147
3900 G-7-VG/1M (C39 G7+5904VG/1M)	2.175,00	039000148
3900 R-7-VG/1M (C39 R7+5904VG/1M)	2.175,00	039000149

5904VG/2T

assortimento di 99 utensili in termoformato

Autoriparazione



T15 T16 T80



T153 T132 T145 T234



T208 T33 T52 T55

14,5 kg

N. pezzi/Descrizione

- 16 chiavi combinate 6÷21 mm
- 5 chiavi combinate 22 - 24 - 27 - 30 - 32 mm
- 19 chiavi a bussola esagonali 1/2"
 - 10÷24 - 26 - 27 - 30 - 32 mm
- 5 chiavi a bussola maschio esagonale 1/2"
 - 5 - 6 - 8 - 10 - 12 mm
- 1 prolunga - 1/2" 125 mm
- 1 prolunga - 1/2" 255 mm
- 1 snodo 1/2"
- 1 quadro maschio 1/2" con spina scorrevole
- 1 cricchetto reversibile 1/2" Ⓢ
- 1 pinze regolabili cerniera chiusa 250 mm
- 1 pinza autobloccante 240 mm
- 1 tronchesi a grande effetto taglienti diagonali 160 mm
- 1 pinza a becchi mezzotondi dritti 160 mm
- 1 pinza universale 180 mm
- 1 pinze becchi dritti per anelli elastici, per fori ○ 180 mm
- 1 pinze becchi dritti per anelli elastici, per alberi ● 175 mm

Beta N.	TR
42	T15
42	T16
920A	T80
920ME	T80
920/21	T80
920/22	T80
920/25	T80
920/42	T80
920/55	T80
1048	T153
1052	T153
1084	T132
1166	T132
1150	T132
1032	T145
1036	T145

N. pezzi/Descrizione

- 1 pinze becchi piegati per anelli elastici, per fori ○ 170 mm
- 1 pinze becchi piegati per anelli elastici, per alberi ● 175 mm
- 2 scalpelli piatti nervati 100 - 200 mm
- 1 martello tipo tedesco 300 g
- 1 mazzuola con battenti in materiale plastico Ø 35 mm
- 4 giravite lama piatta ● 3x75 - 4x100 - 5,5x150 - 6,5x150 mm
- 3 giravite per viti con impronta a croce Phillips®
 - PH0x60 - PH1x80 - PH2x100 mm
- 8 chiavi a forchetta 6x7 - 8x9 - 10x11 - 12x13 - 14x15 - 16x17 - 18x19 - 20x22 mm
- 9 chiavi maschio esagonale piegate
 - 1,5 - 2 - 2,5 - 3 - 4 - 5 - 6 - 8 - 10 mm
- 6 chiavi maschio esagonale con impugnatura
 - 2 - 2,5 - 3 - 4 - 5 - 6 mm
- 6 chiavi maschio con impugnatura per viti con impronta Torx®
 - T10 - T15 - T20 - T25 - T27 - T30

Beta N.	TR
1034	T145
1038	T145
35	T234
1370	T234
1390	T234
1260	T208
1262	T208
55	T33
96/SC9	T33
96T	T52
97TTX	T55

	€ <small>HT</small>	1.067,00 059040191		€ <small>HT</small>	1.695,00 024002624		€ <small>HT</small>	2.225,00 039000125
		1.630,00 024002514			1.695,00 024002625			2.225,00 039000126
		1.630,00 024002515			1.695,00 024002626			
		1.630,00 024002516			2.225,00 039000124			

5904VG/3

assortimento di 132 utensili

Autoriparazione



📦 20,7 kg

N. pezzi/Descrizione

- 6 cacciaspina Ø 2+8 mm
- 1 bulino Ø 5 mm
- 1 scalpelli piatti nervati 200 mm
- 17 chiavi combinate 6+22 mm
- 8 chiavi a forchetta 6x7 - 8x9 - 10x11 - 12x13 - 14x15 - 16x17 - 18x19 - 20x22 mm
- 9 chiavi maschio esagonale piegate Ø 1,5 - 2 - 2,5 - 3 - 4 - 5 - 6 - 8 - 10 mm
- 11 chiavi maschio esagonale con impugnatura Ø 2+10 mm
- 13 chiavi maschio piegate per viti con impronta Torx® ⚙️ T6+T50
- 1 chiave regolabile a rullino 300 mm
- 13 chiavi a bussola esagonali 1/2" con guida Ø 10+22 mm
- 1 prolunga - 1/2" 125 mm
- 1 prolunga - 1/2" 255 mm
- 1 snodo 1/2"
- 1 quadro maschio 1/2" con spina scorrevole
- 1 cricchetto con quadro scorrevole 1/2" ⚙️
- 6 chiavi a T con bussola snodata Ø 8 - 10 - 12 - 13 - 17 - 19 mm
- 1 leva pialla curva con impugnatura 450 mm
- 2 pinze becchi dritti per anelli elastici, per fori Ø 180 - 225 mm
- 2 pinze becchi piegati per anelli elastici, per fori Ø 170 - 210 mm
- 2 pinze becchi dritti per anelli elastici, per alberi ● 175 - 225 mm
- 2 pinze becchi piegati per anelli elastici, per alberi ● 175 - 220 mm
- 1 pinze regolabili cerniera chiusa 250 mm
- 1 pinza autobloccante 240 mm

Beta N.

- 31/B6
- 32
- 35
- 42
- 55
- 96N/SC9
- 96T/SP11
- 97TX/B13
- 111
- 920A/SB13
- 920/21
- 920/22
- 920/25
- 920/42
- 920/50
- 952
- 965
- 1032
- 1034
- 1036
- 1038
- 1048
- 1057A

N. pezzi/Descrizione

- 1 tronchesi a grande effetto taglianti diagonali € 200 mm
- 1 tronchesi doppia leva taglio frontale € 200 mm
- 1 cesoia a lame larghe diritte 250 mm
- 1 forbici per elettricisti lame diritte
- 1 pinza universale = 180 mm
- 4 giravite lama pialla
 - 3x75 - 4x100 - 5,5x125 - 6,5x150 mm
- 1 giravite nano lama pialla ● 6,5x30 mm
- 2 giravite lama pialla con esagono di manovra
 - 8x175 - 10x175 mm
- 3 giravite per viti con impronta a croce Phillips®
 - ⚙️ PH0x100 - PH1x120 - PH2x100 mm
- 1 giravite nano Phillips® ⚙️ PH2x30 mm
- 1 giravite Phillips® con esagono di manovra
 - ⚙️ PH3x175mm
- 1 giravite lungo Phillips® ⚙️ PH2x400 mm
- 1 giravite lama parallela ● 6,5x400 mm
- 1 martello tipo tedesco 500 g
- 1 mazzuola con battenti in materiale plastico Ø 45 mm
- 1 chiave regolabile a nastro per filtri olio
- 1 spessimetro
- 5 lime a taglio mezzodolce 200 mm
- 1 seghetto
- 1 oliatore in metallo a pressione 200 cc

Beta N.

- 1084BM
- 1092V
- 1112
- 1128BMX
- 1150BM
- 1260
- 1260N
- 1260E
- 1262
- 1262N
- 1262E
- 1262L
- 1264L
- 1370
- 1390
- 1491
- 1708/20
- 1719BMA/S5
- 1726BM
- 1751

€ 📦

5904VG/3 1.630,00 059040192

€ 📦

2400S7-G/VG3 2.320,00 024002735
(C24S7/G+5904VG/3)

€ 📦

2400S8-O/VG3 2.370,00 024002814
(C24S8/O+5904VG/3)



2400SL-O/VG3 2.630,00 024002414
(C24SL/O+5904VG/3)



2400S7-R/VG3 2.320,00 024002736
(C24S7/R+5904VG/3)



2400S8-G/VG3 2.370,00 024002815
(C24S8/G+5904VG/3)



2400SL-G/VG3 2.630,00 024002415
(C24SL/G+5904VG/3)



2400SA7-O/VG3 2.370,00 024002737
(C24SA7/O+5904VG/3)



2400S8-R/VG3 2.370,00 024002816
(C24S8/R+5904VG/3)



2400SL-R/VG3 2.630,00 024002416
(C24SL/R+5904VG/3)



2400SA7-G/VG3 2.370,00 024002738
(C24SA7/G+5904VG/3)



2400S7-O/VG3 2.320,00 024002734
(C24S7/O+5904VG/3)



2400SA7-R/VG3 2.370,00 024002739
(C24SA7/R+5904VG/3)

5904VG/5T

assortimento di 153 utensili in termoformato

Autoriparazione

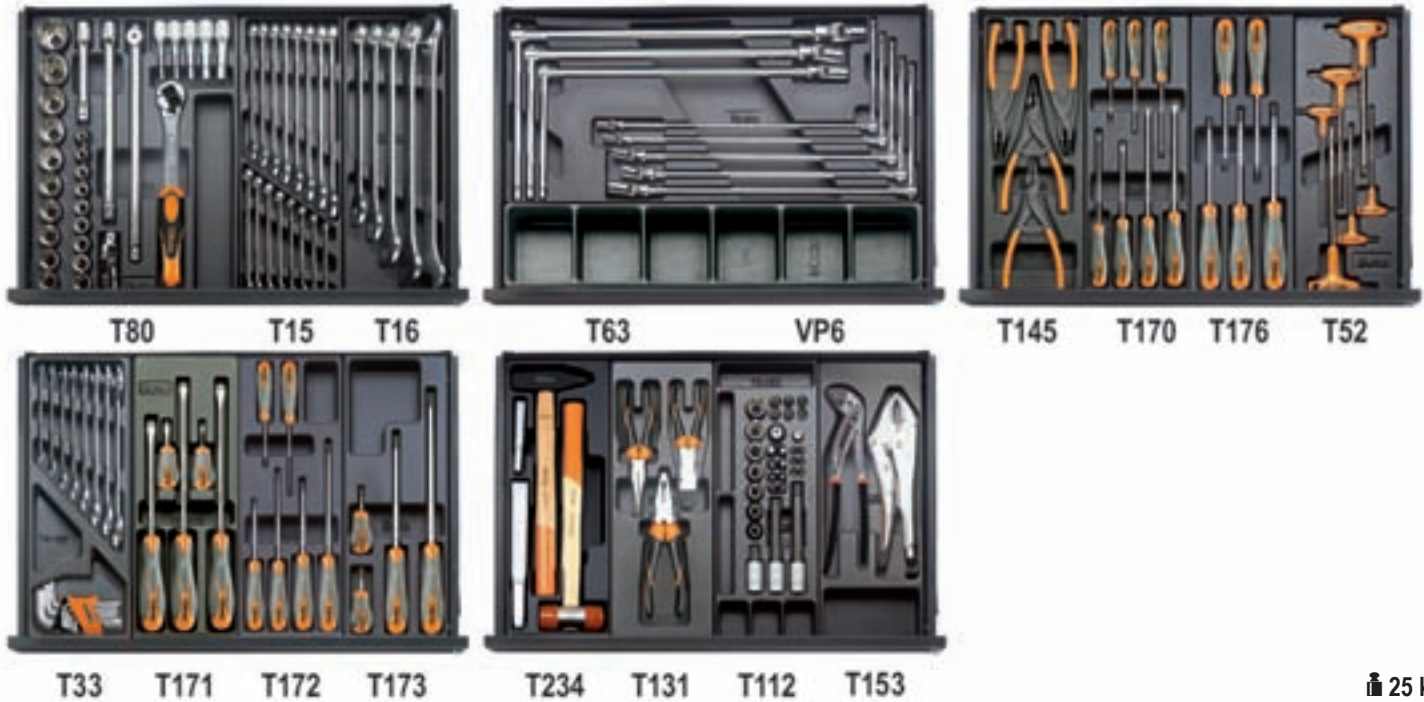

25 kg

N. pezzi/Descrizione

N. pezzi/Descrizione	Beta N.	TR
5 chiavi a bussola maschio esagonale 1/2"	920ME	T80
○ 5 - 6 - 8 - 10 - 12 mm		
1 prolunga - 1/2" 125 mm	920/21	T80
1 prolunga - 1/2" 255 mm	920/22	T80
1 snodo 1/2"	920/25	T80
1 quadro maschio 1/2" con spina scorrevole	920/42	T80
1 cricchetto reversibile 1/2" ⊕	920/55	T80
19 chiavi a bussola esagonali 1/2"	920A	T80
○ 10÷24 - 26 - 27 - 30 - 32 mm		
16 chiavi combinate 6÷21 mm	42	T15
5 chiavi combinate 22 - 24 - 27 - 30 - 32 mm	42	T16
8 chiavi a T con bussola snodata	952	T63
○ 7 - 8 - 10 - 12 - 13 - 14 - 17 - 19 mm		
termoformato vuoto	VP6	VP6
1 pinze becchi dritti per anelli elastici, per fori ○ 180 mm	1032	T145
1 pinze becchi piegati per anelli elastici, per fori ○ 170 mm	1034	T145
1 pinze becchi dritti per anelli elastici, per alberi ● 175 mm	1036	T145
1 pinze becchi piegati per anelli elastici, per alberi ● 175 mm	1038	T145
7 giravite lama piatta ● 2,5x50 - 3x75 - 3,5x100 - 4x125 - 5,5x100 - 5,5x150 - 6,5x150 mm	1290	T170
5 chiavi maschio con impugnatura per viti con impronta Torx®	1297TX	T176
⊕ T25 - T27 - T30 - T40 - T45		
6 chiavi maschio esagonale con impugnatura	96T	T52
○ 2 - 2,5 - 3 - 4 - 5 - 6 mm		
12 chiavi a forchetta 6x7 - 8x9 - 10x11 - 12x13 - 14x15 - 16x17 - 18x19 - 20x22 mm	55	T33
9 chiavi maschio esagonale piegate	96N/SC9	T33
○ 1,5 - 2 - 2,5 - 3 - 4 - 5 - 6 - 8 - 10 mm		

Beta N. TR

N. pezzi/Descrizione

N. pezzi/Descrizione	Beta N.	TR
3 giravite lama piatta	1290	T171
● 8x150 - 8x200 - 10x200 mm		
2 giravite nano lama piatta	1290N	T171
● 4x30 - 6,5x30 mm		
6 giravite Phillips® ⊕ PH0x60 - PH0x100 - PH1x80 - PH1x120 - PH2x100 - PH2x150 mm	1292	T172
2 giravite Phillips® ⊕ PH3x150 - PH4x200 mm	1292	T173
2 giravite nano Phillips® ⊕ PH1x30 - PH2x30 mm	1292N	T173
2 scalpelli piatti nervati 100 - 200 mm	35	T234
1 martello tipo tedesco 300 g	1370	T234
1 mazzuola con battenti in materiale plastico Ø 35 mm	1390	T234
1 pinza universale = 180 mm	1150BM	T131
1 pinza a becchi mezzotondi dritti ● 160 mm	1166BM	T131
1 tronchesi a grande effetto taglienti diagonali ⚡ 160 mm	1084BM	T131
8 inserti per avvitatori per viti con impronta Torx® ⊕ T6÷T15	861TX	T112
8 inserti per avvitatori per viti con impronta Torx® ⊕ T20÷T55	866TX	T112
1 bussola portainseri	895/1	T112
1 bussola portainseri	895/6	T112
1 chiavi a bussola 1/4" per viti con teste a profilo Torx® ⊕ E4÷E10	900FTX	T112
1 chiavi a bussola 1/2" per viti con teste a profilo Torx® ⊕ E12÷E24	920FTX	T112
1 chiavi a bussola maschio per viti con impronta Torx® 1/2" ⊕ T55L - T60 - T70L	920TX	T112
1 pinze regolabili cerniera chiusa 250 mm	1048	T153
1 pinza autobloccante 240 mm	1052	T153

Beta N. TR

5904VG/5T € 1.700,00 059040196

2400S8-OVG5T € 2.440,00 024002824
(C24S8/O+5904VG/5T)

2400S8-GVG5T € 2.440,00 024002825
(C24S8/G+5904VG/5T)

2400S8-RVG5T € 2.440,00 024002826
(C24S8/R+5904VG/5T)

3900 O-8VG5T € 3.020,00 039000184
(C39 O/8+5904VG/5T)

3900 G-8VG5T € 3.020,00 039000185
(C39 G/8+5904VG/5T)

3900 R-8VG5T € 3.020,00 039000186
(C39 R/8+5904VG/5T)

2400SAXL-OVG5T € 2.590,00 024002454
(C24SA-XL/7O +5904VG/5T)

2400SAXL-GVG5T € 2.590,00 024002455
(C24SA-XL/7G +5904VG/5T)

2400SAXL-RVG5T € 2.590,00 024002456
(C24SA-XL/7R +5904VG/5T)

5905VG/1

assortimento di 94 utensili per carrozzieri

Autoriparazione



20 kg

N. pezzi/Descrizione

- 1 punzoni Ø 4 mm
- 6 cacciaspina Ø 2 - 3 - 4 - 5 - 6 - 8 mm
- 1 bulino Ø 4 mm
- 1 scalpelli piatti 150 mm
- 1 ugnetti 150 mm
- 17 chiavi combinate 6+22 mm
- 10 chiavi maschio esagonale piegate \odot 1,5+12 mm
- 1 chiave regolabile a rullino 300 mm
- 12 chiavi a bussola con impugnatura, tipo lungo \odot 4+14 mm
- 1 leva piatta curva con impugnatura 450 mm
- 1 pinze regolabili cerniera chiusa 250 mm
- 1 pinza autobloccante 240 mm
- 1 pinza autobloccante ganasce alluminio 280 mm
- 1 tronchesi a grande effetto taglienti diagonali \sphericalangle 160 mm
- 1 tenaglia per cementisti 250 mm
- 1 cesoia a doppia leva dritta
- 1 forbici per elettricisti lame dritte
- 1 pinza universale \equiv 180 mm
- 1 giravite Dzus® \bullet
- 4 giravite lama piatta \bullet 3x75 - 4x100 - 5,5x150 - 6,5x150 mm
- 1 giravite nano lama piatta \bullet 4x30 mm

Beta N.

- 30
- 31/B6
- 32
- 34
- 36
- 42/S17
- 96/B10
- 111N
- 943BX
- 965
- 1048
- 1052
- 1060AL
- 1084BM
- 1098PL
- 1122
- 1128BMX
- 1150BM
- 1201DZ
- 1260
- 1260N

N. pezzi/Descrizione

- 2 giravite lama piatta con esagono di manovra \bullet 10x175 - 12x200 mm
- 3 giravite per viti con impronta a croce Phillips®
 \oplus PH0x60 - PH1x80 - PH2x100 mm
- 1 giravite nano Phillips® \oplus PH1x30 mm
- 1 giravite Phillips® con esagono di manovra \oplus PH3x175 mm
- 7 chiave maschio per viti con impronta Torx®
 \odot T6 - T8 - T10 - T15 - T20 - T25 - T30
- 1 tasso a virgola 1350 g
- 1 tasso curvo
- 1 tasso a tacco bombato
- 1 tasso a rotaia
- 1 tasso a tampone
- 1 leva a cazzuola
- 1 leva a cucchiaino pesante
- 1 leva a gomito e piana
- 1 lima e portailima
- 1 scalpello extrapiatto con paramano
- 1 martello con testa tonda e penna
- 1 martello con testa tonda e quadra Ø 32 mm
- 1 martello tipo tedesco 300 g
- 1 mazzuola con battenti in materiale plastico Ø 35 mm
- 1 flessometro 5 m

Beta N.

- 1260E
- 1262
- 1262N
- 1262E
- 1267TX
- 1303
- 1305
- 1306
- 1310
- 1313
- 1326
- 1327
- 1330
- 1338A
- 1342PM
- 1345
- 1357Z/32
- 1370
- 1390
- 1692

5905VG/1

€ 1.475,00  059050157



2500/VG1
(C25+5905VG/1)

€ 2.045,00 025000082

5905VG/2

assortimento di 118 utensili

Autoriparazione



19,5 kg

N. pezzi/Descrizione

6	2 punzoni, 1 bulino, 3 scalpelli con supporto
14	chiavi combinate 6+14 - 17 - 19 - 22 - 24 mm
13	chiavi a forchetta 6x7 - 8x9 - 10x11 - 12x13 - 14x15 - 16x17 - 18x19 - 20x22 - 21x23 - 24x26 - 25x28 - 27x29 - 30x32 mm
3	chiavi poligonali doppie starter 11x13 - 14x17 - 19x22 mm
10	chiavi maschio esagonale piegate \odot 1,5+12 mm
6	chiavi maschio con impugnatura per viti con impronta Torx®
	\odot T10 - T15 - T20 - T25 - T30 - T40
2	chiavi a bussola Macchina 1/2" \odot 17 - 19 mm
20	chiavi a bussola esagonali 1/2"
	\odot 10+24 - 26 - 27 - 28 - 30 - 32 mm
1	prolunga - 1/2" 125 mm
1	prolunga - 1/2" 255 mm
1	snodo 1/2"
1	quadro maschio 1/2" con spina scorrevole
1	cricchetto reversibile 1/2" \otimes
8	chiavi a T con bussola snodata
	\odot 7 - 8 - 10 - 11 - 13 - 14 - 17 - 19 mm
1	chiavi a T con bussola snodata per candele
1	chiave a croce \odot 17x19x22x \blacksquare 1/2"
1	pinze becchi diritti per anelli elastici, per fori \odot 180 mm
1	pinze becchi piegati per anelli elastici, per fori \odot 170 mm
1	pinze becchi diritti per anelli elastici, per alberi \bullet 175 mm

Beta N.

38/B6
42
55
83
96N/B10
97TTX
720
920A
920/21
920/22
920/25
920/42
920/55
952
959
979
1032
1034
1036

N. pezzi/Descrizione

1	pinze becchi piegati per anelli elastici, per alberi \bullet 175 mm
1	pinze regolabili cerniera chiusa 250 mm
1	pinza autobloccante 240 mm
1	tronchesi a grande effetto taglienti diagonali ∇ 160 mm
1	cesoia a doppia leva dritta 250 mm
1	forbici per elettricisti lame diritte
1	pinza universale \equiv 180 mm
1	pinza a becchi mezzotondi diritti \bullet 160 mm
8	giravite lama piatta \bullet 2,5x50 - 3x75 - 3,5x100 - 4x125 - 5,5x150 - 6,5x150 - 8x200 - 10x200 mm
2	giravite lama piatta con esagono di manovra \bullet 10x175 - 12x200 mm
1	giravite nano lama piatta \bullet 6,5x30 mm
4	giravite per viti con impronta a croce Phillips® \oplus PH0x60 - PH1x80 - PH2x100 - PH3x150 mm
1	martello tipo tedesco 400 g
1	mazzuola con battenti in materiale plastico \varnothing 35 mm
1	chiave regolabile a nastro per filtri olio
1	provatensione 3+48 V

Beta N.

1038
1048
1052
1084BM
1122
1128BMX
1150BM
1166BM
1260
1260E
1260N
1262
1370
1390
1491
1498



5905VG/2 1.425,00 059050144



2500/VG2 1.995,00 025000084
(C25+5905VG/2)

Autoriparazione



N. pezzi/Descrizione

Beta N. TR

N. pezzi/Descrizione

Beta N. TR

16	chiavi combinate 6+21 mm	42	T15	1	prolunga Macchina con attacchi quadri maschio e femmina 1/2" 125 mm	720/21	T110
5	chiavi combinate 22 - 24 - 27 - 30 - 32 mm	42	T16	5	chiavi a bussola maschio esagonale 1/2"	920PE	T113
5	cacciaspina Ø 2 - 3 - 4 - 5 - 6 mm	31	T31	4	chiavi a bussola maschio per viti con impronta Torx® 1/2"	920TX	T113
1	bulino Ø 4 mm	32	T31	3	chiavi a bussola maschio a profilo XZN®	920XZN	T113
12	chiavi a forchetta 6x7 - 8x9 - 10x11 - 12x13 - 14x15 - 16x17 - 18x19 - 20x22 - 21x23 - 24x26 - 27x29 - 30x32 mm	55	T31	5	lime a taglio mezzodolce 200 mm	1719BMA8/	T236
9	chiavi maschio esagonale piegate	96N/SC9	T31	1	chiave regolabile a nastro per filtri olio 110 mm	1491	T264
1	1,5 - 2 - 2,5 - 3 - 4 - 5 - 6 - 8 - 10 mm	920ME	T80	1	chiave a bussola quadrata per tappi olio motore ■ 10 mm	1494	T264
5	chiavi a bussola maschio esagonale 1/2"	920/21	T80	7	chiavi a bussola maschio esagonale per tappi olio motore ○	1494E	T264
1	5 - 6 - 8 - 10 - 12 mm	920/22	T80	8-9-10-11-12-14-17 mm	1494Q	T264	
1	prolunga - 1/2" 125 mm	920/25	T80	4	chiavi a bussola maschio quadrato per tappi olio motore ○	1494T	T264
1	prolunga - 1/2" 255 mm	920/42	T80	1	chiave a bussola maschio triangolare per tappi olio motore Δ	1494XZN	T264
1	snodo 1/2"	920/55	T80	1	chiave a bussola maschio con profilo XZN® per tappi olio motore ○	1496/C	T264
1	quadro maschio 1/2" con spina scorrevole	920A	T80	2	scalpelli piatti nervati 100 - 200 mm	35	T234
1	cricchetto reversibile 1/2" ⊕	1032	T145	1	martello tipo tedesco 300 g	1370	T234
19	chiavi a bussola esagonali 1/2" ○ 10+24 - 26 - 27 - 30 - 32 mm	1034	T145	1	mazzuola con battenti in materiale plastico Ø 35 mm	1390	T234
1	pinze becchi dritti per anelli elastici, per fori ○ 180 mm	1036	T145	1	pinze regolabili cerniera chiusa 250 mm	1048	T153
1	pinze becchi piegati per anelli elastici, per fori ○ 170 mm	1038	T145	1	pinza autobloccante 240 mm	1052	T153
1	pinze becchi dritti per anelli elastici, per alberi ● 175 mm	1032	T146	1	pinza universale ■ 180 mm	1150	T132
1	pinze becchi piegati per anelli elastici, per alberi ● 175 mm	1034	T146	1	pinza a becchi mezzotondi dritti ● 160 mm	1166	T132
1	pinze becchi dritti per anelli elastici, per fori ○ 140 mm	1034	T146	1	tronchesi a grande effetto taglienti diagonali ⚡ 160 mm	1084	T132
1	pinze becchi piegati per anelli elastici, per fori ○ 225 mm	1036	T146	11	chiavi a bussola esagonali 3/4" ○ 22-24-27-30-32-34-36-38-41-46-50 mm	928A	T105
1	pinze becchi dritti per anelli elastici, per alberi ● 140 mm	1038	T146	1	prolunga - 3/4" 200 mm	928/21	T106
1	pinze becchi piegati per anelli elastici, per alberi ● 225 mm	1038	T146	1	prolunga - 3/4" 380 mm	928/22	T106
9	giravite lama piatta ● 3x75 - 3,5x100 - 4x100 - 4x150 - 5,5x100 - 5,5x150 - 6,5x150 - 8x150 - 10x200 mm	1260	T167	1	quadro maschio 3/4" con spina scorrevole 450 mm	928/42	T106
2	giravite nano lama piatta ● 4x30 - 6,5x30 mm	1262N	T167	1	cricchetto reversibile 3/4" ⊕ termoformato vuoto	928/55	T106
7	giravite per viti con impronta a croce Phillips®	1262	T168	4	chiavi maschio esagonale piegate ○ 13-14-17-19 mm	96N	VP6
1	PH0x60 - PH0x100 - PH1x80 - PH1x120 - PH2x100 - PH2x150 - PH3x150 mm	1262N	T168	1	chiave regolabile a rullino 300 mm	111	
2	giraviti nano Phillips® ● PH1x30 - PH2x30 mm	952	T63	1	leva piatta curva con impugnatura	965	
8	chiavi a T con bussola snodata	1262L	T209	1	cesoia a lame larghe diritte 250 mm	1112	
1	7 - 8 - 10 - 12 - 13 - 14 - 17 - 19 mm	1264L	T209	1	forbici per elettricisti lame diritte	1128BMX	
2	giravite lungo Phillips®	97TTX	T55	1	martello tipo tedesco 1000 g	1370	
1	PH1x400 - PH2x400 mm	720	T110	1	spessimetro	1708/20	
3	giravite lungo lama parallela			1	magnete telescopico punta flessibile	1712	
1	● 3x300 - 4x400 - 5x400 mm			1	specchietto telescopico	1715	
6	chiavi maschio con impugnatura per viti con impronta Torx®			1	raschietto a tre taglienti 200 mm	1717B	
1	○ T10-T15-T20-T25-T27-T30			1	seghetto 440 mm	1726	
14	chiavi a bussola Macchina 1/2" ○ 10-11-12-13-14-15-16-17-18-19-21-22-23-24 mm			1	spazzola fili d'ottone	1737	
				1	oliatore in metallo a pressione 200 cl	1751	
				1	cutter con lama a settori	1771	

5908VG/2T 2.850,00 059080117

2800 O/VG/2T 4.680,00 028000347 (C28 O+5908VG/2T)

2800 G/VG/2T 4.680,00 028000348 (C28 G+5908VG/2T)

2800 R/VG/2T 4.680,00 028000349 (C28 R+5908VG/2T)

Autoriparazione



N. pezzi/Descrizione

N. pezzi/Descrizione	Beta N.	TR
16 chiavi combinate 6÷21 mm	42	T15
5 chiavi combinate 22 - 24 - 27 - 30 - 32 mm	42	T16
6 chiavi a bussola poligonale snodate doppie 8x9 - 10x11 - 12x13 - 14x15 - 16x17 - 18x19 mm	80	T79
1 chiave regolabile a nastro per filtri olio 110 mm	1491	T264
1 chiave a bussola quadrata per tappi olio motore 10 mm	1494	T264
7 chiavi a bussola maschio esagonale per tappi olio motore 8-9-10-11-12-14-17 mm	1494E	T264
4 chiavi a bussola maschio quadrato per tappi olio motore 8-9,5-12-13 mm	1494Q	T264
1 chiave a bussola maschio triangolare per tappi olio motore 14	1494T	T264
1 chiave a bussola maschio con profilo XZN® per tappi olio motore	1494XZN	T264
1 chiavi per tappi olio motore	1496/C	T264
5 chiavi a bussola maschio esagonale 1/2" 5 - 6 - 8 - 10 - 12 mm	920ME	T80
1 prolunga - 1/2" 125 mm	920/21	T80
1 prolunga - 1/2" 255 mm	920/22	T80
1 snodo 1/2"	920/25	T80
1 quadro maschio 1/2" con spina scorrevole	920/42	T80
1 cricchetto reversibile 1/2"	920/55	T80
19 chiavi a bussola esagonali 1/2" 10÷24 - 26 - 27 - 30 - 32 mm	920A	T80
1 pinze becchi dritti per anelli elastici, per fori 180 mm	1032	T145
1 pinze becchi piegati per anelli elastici, per fori 170 mm	1034	T145
1 pinze becchi dritti per anelli elastici, per alberi 175 mm	1036	T145
1 pinze becchi piegati per anelli elastici, per alberi 175 mm	1038	T145
1 pinze becchi dritti per anelli elastici, per fori 140 mm	1032	T146
1 pinze becchi piegati per anelli elastici, per fori 225 mm	1034	T146
1 pinze becchi dritti per anelli elastici, per alberi 140 mm	1036	T146
1 pinze becchi piegati per anelli elastici, per alberi 225 mm	1038	T146
6 chiavi maschio con impugnatura per viti con impronta Torx® T10-T15-T20-T25-T27-T30	97TTX	T55
12 chiavi combinate a cricchetto snodate 8 - 9 - 10 - 11 - 12 - 13 - 14 - 15 - 16 - 17 - 18 - 19 mm	142SN	T46
1 pinza universale 180 mm	1150BM	T131

N. pezzi/Descrizione

N. pezzi/Descrizione	Beta N.	TR
1 pinza a becchi mezzotondi dritti 160 mm	1166BM	T131
1 tronchesi a grande effetto taglienti diagonali 160 mm	1084BM	T131
1 pinza regolabile a pulsante 240 mm	1047	T151
1 pinza autobloccante 240 mm	1057A	T151
8 chiavi a T con bussola snodata 7 - 8 - 10 - 12 - 13 - 14 - 17 - 19 mm	952	T63
9 giravite lama piatta 3x75 - 3,5x100 - 4x100 - 4x150 - 5,5x100 - 5,5x150 - 6,5x150 - 8x150 - 10x200 mm	1260	T167
2 giravite nano lama piatta 4x30 - 6,5x30 mm	1260N	T167
1 cacciaspina	31/B6	
7 giravite per viti con impronta a croce Phillips® PH0x60 - PH0x100 - PH1x80 - PH1x120 - PH2x100 - PH2x150 - PH3x150 mm	1262	T168
2 giraviti nano Phillips® PH1x30 - PH2x30 mm	1262N	T168
1 chiave regolabile a rullino 250 mm	111	T59
1 quadro maschio a T snodato 1/2"	920/40	T59
6 chiavi a T maschio esagonale 2,5-3-4-5-6-8 mm	951	T59
4 chiavi a T con maschio esagonale snodato 4-5-6-8 mm	953	T59
2 martello tipo tedesco 300-500 g	1370	T59
2 giravite lungo Phillips® PH1x400 - PH2x400 mm	1262L	T209
3 giravite lungo lama parallela 3x300 - 4x400 - 5x400 mm	1264L	T209
1 chiavi maschio esagonale piegate con estremità sferica 96BPC/SC9		
1 chiave dinamometrica a scatto 8 ÷ 60 Nm	606/6	
1 chiave dinamometrica a scatto 60 ÷ 330 Nm	606/30	
1 chiavi a bussola Macchina	720/C12	
1 raccordo quadro maschio 1/2" e femmina 3/8"	910/16	
1 assortimento di 12 chiavi a bussola e 5 accessori 3/4"	928A/C12	
1 leva con testa snodata piatta curva	966/C3	
1 mazzuola antirimbalo Ø 50 mm	1392	
1 avvitatore reversibile in materiale composito	1927P	

5910VG/3T

€ 4.050,00 059100067



3000SVG3T (C30S+5910VG/3T)

€ 6.950,00 030000097

Motoriparazione



N. pezzi/Descrizione

1 punzoni Ø 2 mm	Beta N. 30
1 bulino Ø 4 mm	32
1 scalpelli piatti 125 mm	34
10 chiavi combinate 6 - 7 - 8 - 10 - 11	42
12 - 13 - 14 - 17 - 19 mm	
1 chiavi combinate 12 mm	42
6 chiavi a forchetta 6x7 - 8x9 - 10x11	55
12x13 - 14x15 - 16x17 mm	
9 chiavi maschio esagonale piegate	96/SC9
Ø 1,5 - 2 - 2,5 - 3 - 4 - 5 - 6 - 8 - 10 mm	
1 chiave dinamometrica a scatto 3/8", 8+60 Nm	606/6
54 assortimento di 52 inserti con attacco esagonale 10 mm e 2 accessori	867/C52
17 assortimento di 12 chiavi a bussola e 5 accessori	920A/C12X
1 raccordo quadro maschio 1/2" e femmina 3/8"	910/16
2 chiavi a bussola per candele 3/8" Ø 16 - 17,8 mm	956E
1 pinza a becchi mezzotondi lunghissimi ● 283 mm	1009L/A
2 pinze becchi dritti per anelli elastici,	1032
per fori Ø 140 - 180 mm	
1 pinze becchi dritti per anelli elastici, per alberi ● 140x1,3 mm	1036

N. pezzi/Descrizione

1 pinza autobloccante 235 mm	Beta N. 1054
1 tronchesi a taglienti diagonali 160 mm	1082
1 pinza universale = 180 mm	1150
1 giravite Dzus® ●	1201DZ
4 giravite lama piatta	1201
● 3x75 - 4x100 - 5,5x100 - 6,5x150 mm	
3 giravite Phillips®	1202
● PH0x60 - PH1x80 - PH2x100 mm	
1 giravite provacircuito ●	1254
1 martello tipo tedesco 300 g	1370
1 pinza per fascette a scatto Clic®	1472FS
2 pinze in plastica per occlusione tubi	1481PL/A-B
1 chiave regolabile a nastro per filtri olio	1491
1 spessimetro	1708/13
3 lime ad ago	1720/S3
1 miniseghetto	1725CR
1 spazzola fili d'ottone	1737
1 oliatore in plastica a pressione 250 cc	1754
1 cutter	1770A
1 snodo 3/8"	910/25

5940SBK

€ 1.016,00 059400071



4100S/SBK
(C41S+5940/SBK)

€ 1.360,00 041000104



4100H/SBK
(C41H+5940/SBK)

€ 1.410,00 041000114

Autoriparazione



24,6 kg

N. pezzi/Descrizione

5	cacciaspina Ø 2 - 3 - 4 - 5 - 6 mm
1	bulino Ø 4 mm
1	scalpelli piatti 150 mm
18	chiavi combinate 6 - 7 - 8 - 9 - 10 - 11 - 12 - 13 - 14 - 17 - 18 - 19 - 21 - 22 - 24 - 27 - 30 mm
12	chiavi a forchetta 6x7 - 8x9 - 10x11 - 12x13 - 14x15 - 16x17 - 18x19 - 20x22 - 21x23 - 24x26 - 27x29 - 30x32 mm
3	chiavi poligonali doppie starter 11x13 - 14x17 - 19x22 mm
12	chiavi maschio esagonale piegate Ø 2÷10 mm
11	chiavi maschio esagonale con impugnatura Ø 2÷8 - 10 mm
20	chiavi a bussola esagonali 1/2" Ø 10÷24 - 26 - 27 - 28 - 30 - 32 mm
5	chiavi a bussola maschio esagonale 1/2" Ø 5 - 6 - 8 - 10 - 12 mm
1	prolunga - 1/2" 125 mm
1	prolunga - 1/2" 255 mm
1	snodo 1/2"
1	quadro maschio 1/2" con spina scorrevole
1	cricchetto reversibile 1/2" ®
10	chiavi a T con bussola snodata Ø 6 - 7 - 8 - 10 - 11 - 12 - 13 - 14 - 17 - 19 mm
2	chiavi a T con bussola snodata per candele 16 - 20,8 mm
1	chiave a croce Ø 17x19x22x 1/2"
2	pinze becchi dritti per anelli elastici, per fori Ø 140 - 180 mm
1	pinze becchi piegati per anelli elastici, per fori Ø 170 mm
2	pinze becchi dritti per anelli elastici, per alberi Ø 140x1,3 - 175 mm
1	pinze becchi piegati per anelli elastici, per alberi Ø 175 mm
1	pinze regolabili cerniera chiusa 250 mm

Beta N.

31
32
34
42
55
83
96
96T
920A
920ME
920/21
920/22
920/25
920/42
920/55
952
959
979
1032
1034
1036
1038
1048

N. pezzi/Descrizione

1	pinza autobloccante 240 mm	1052
1	tronchesi a grande effetto taglienti diagonali 160 mm	1084BM
1	cesoia a lame larghe diritte 250 mm	1112
1	forbici per elettricisti lame diritte	1128BMX
1	pinza universale 180 mm	1150BM
5	giravite lama piatta Ø 3x75 - 4x100 - 5,5x100 - 6,5x150 - 10x200 mm	1260
2	giravite nano lama piatta Ø 4x30 - 6,5x30 mm	1260N
4	giravite per viti con impronta a croce Phillips® PH0x60 - PH1x80 PH2x100 - PH3x150 mm	1262
2	giraviti nano Phillips® PH1x30 - PH2x30 mm	1262N
1	giravite lungo Phillips® PH2x400 mm	1262L
1	giravite lungo lama parallela Ø 6,5x400 mm	1264L
1	martello tipo tedesco 400 g	1370
1	mazzuola con battenti in materiale plastico Ø 35 mm	1390
1	pinza per anelli elastici SP	1458
1	chiave regolabile a nastro per filtri olio	1491
1	pinza per capicorda non isolati	1603
1	spessimetro	1708/13
1	flessibile magnetico 0,5 kg	1712E/1
5	200 mm	1719BMA/S5
1	seghetto	1726BM
1	oliatore in plastica a pressione 250 cc	1754

5953VG

1.845,00 059530085



5300VG

(C53VG+5953VG)

2.600,00 053000025

5954VG

assortimento di 138 utensili

Autoriparazione



18,9 kg

N. pezzi/Descrizione

- 5 cacciaspina Ø 2 - 3 - 4 - 5 - 6 mm
- 1 bulino Ø 4 mm
- 1 scalpelli piatti 125 mm
- 18 chiavi combinate 6÷22 - 24 mm
- 8 chiavi a forchetta 6x7 - 8x9 - 10x11 - 12x13
14x15 - 16x17 - 18x19 - 20x22 mm
- 3 chiavi poligonali curve 12x13 - 14x15 - 17x19 mm
- 13 chiavi maschio esagonale piegate \odot 2÷10 - 12 mm
- 3 chiavi a bussola Macchina 1/2" \odot 17 - 19 - 22 mm
- 1 quadro maschio a T snodato 3/8"
- 20 chiavi a bussola esagonali 1/2"
 \odot 10÷24 - 26 - 27 - 28 - 30 - 32 mm
- 1 prolunga - 1/2" 125 mm
- 1 prolunga - 1/2" 255 mm
- 1 snodo 1/2"
- 1 quadro maschio 1/2" con spina scorrevole
- 1 cricchetto reversibile 1/2" \oplus
- 4 chiavi a bussola con impugnatura,
tipo lungo \odot 6 - 7 - 8 - 10 mm
- 10 chiavi a T con bussola snodata
 \odot 6 - 7 - 8 - 10 - 11 - 12 - 13 - 14 - 17 - 19 mm
- 3 chiavi a bussola per candele 3/8"
 \odot 16 - 17,8 - 20,8 mm
- 1 leva con estremità a punta e a becco
- 1 pinze becchi dritti per anelli elastici,
per fori \odot 180 mm
- 1 pinze becchi piegati per anelli elastici,
per fori \odot 170 mm
- 1 pinze becchi dritti per anelli elastici,
per alberi \bullet 175 mm
- 1 pinze becchi piegati per anelli elastici, per alberi \bullet 175 mm

Beta N.

- 31
- 32
- 34
- 42
- 55
- 90
- 96
- 720
- 910/40
- 920A
- 920/21
- 920/22
- 920/25
- 920/42
- 920/55
- 943BX
- 952
- 956E
- 964
- 1032
- 1034
- 1036
- 1038

N. pezzi/Descrizione

- 1 pinze regolabili cerniera chiusa 250 mm
- 1 pinza autobloccante 240 mm
- 1 pinza autobloccante becchi lunghi 180 mm
- 1 tronchesi a taglienti diagonali \leq 160 mm
- 1 forbici per elettricisti lame diritte
- 1 pinza universale \equiv 180 mm
- 1 pinza a becchi mezzotondi dritti \bullet 160 mm
- 1 giravite provacircuito \bullet 6÷24V
- 6 giravite lama piatta \bullet 3x75 - 3,5x100 - 4x125
5,5x150 - 6,5x150 - 10x200 mm
- 1 giravite nano lama piatta \bullet 6,5x30 mm
- 3 giravite per viti con impronta a croce Phillips® \oplus PH0x60 - PH1x80 -
PH2x100 mm
- 1 giraviti nano Phillips® \oplus PH2x30 mm
- 5 chiave maschio per viti con impronta Torx®
 \odot T8 - T10 - T15 - T20 - T25
- 1 martello tipo tedesco 300 g
- 1 mazzuola antirimbazzo Ø 35 mm
- 1 pinza molle freni 210 mm
- 1 pinza per capicorda non isolati
- 1 flessometro 5 m
- 1 spessimetro
- 1 flessibile magnetico 1,8 kg
- 6 lime ad ago 160 mm
- 1 oliatore in plastica a pressione 150 cc

Beta N.

- 1048
- 1052
- 1058
- 1082BM
- 1128BMX
- 1150BM
- 1166BM
- 1254
- 1260
- 1260N
- 1262
- 1262N
- 1267TX
- 1370
- 1392
- 1470
- 1603
- 1692
- 1708/20
- 1712E/2
- 1720/B6
- 1754

5954VG

€ 1.550,00  059540085



5400 GVG
(C54VG G+5954VG)

€ 2.230,00  054000162



5400 OVG
(C54VG O+5954VG)

€ 2.230,00 054000160



5400 RVG
(C54VG R+5954VG)

€ 2.230,00 054000164

Autoriparazione



36,6 kg

N. pezzi/Descrizione

6	cacciaspina Ø 2 - 3 - 4 - 5 - 6 - 8 mm	Beta N.	31/SP6
6	2 punzoni, 1 bulino, 3 scalpelli con supporto		38/SP6
19	chiavi combinate 6÷22 - 24 - 27 mm		42
12	chiavi poligonali curve 6x7 - 8x9 - 10x11 - 12x13 - 14x15 - 16x17 - 18x19 - 20x22 - 21x23 - 24x27 - 25x28 - 30x32 mm		90/S12X
7	chiavi maschio esagonale piegate Ø 2,5÷10 mm		96N/G7
12	chiavi maschio esagonale piegate Ø 2÷10 mm		96/SC12
13	chiavi maschio piegate per viti con impronta Torx® ⚙ T6÷T50		97TX/B13
5	chiavi maschio XZN® piegate M5÷M12		98XZN/G
1	chiave regolabile a rullino 250 mm		111
1	chiave dinamometrica a scatto 1/2", 40÷200 Nm		606/20
2	chiavi a bussola Macchina 1/2" Ø 17 - 19 mm		720
13	chiavi a bussola poligonali 1/2" con guida Ø 10÷22 mm		920B/SB13
8	chiavi a bussola poligonali 1/2" con guida Ø 23÷32 mm		920B/SB8
4	chiavi a bussola a giravite lama piatta 1/2" Ø 1,2x6,5 - 1,2x8 - 1,6x9 - 2x12 mm		920LP
3	chiavi a bussola a giravite lama Phillips® 1/2" ⚙ PH2 - 3 - 4		920PH
1	prolunga - 1/2" 125 mm		920/21
1	prolunga - 1/2" 255 mm		920/22
1	snodo 1/2"		920/25
1	quadro maschio snodato 1/2" con impugnatura		920/35A
1	quadro maschio 1/2" con spina scorrevole		920/42
1	cricchetto reversibile 1/2" ⚙		920/55
7	chiavi a T con bussola snodata Ø 8 - 10 - 11 - 13 - 14 - 17 - 19 mm		952
2	chiavi a T con bussola snodata per candele 16 - 20,8 mm		959
1	leva con estremità a punta e piastra curva		963
1	chiave a croce Ø 17x19x22x 1/2"		983
1	pinzetta punta fini curve 120 mm		991
1	pinzetta punta larghe diritte 150 mm		994
2	pinze becchi diritti per anelli elastici, per fori Ø 140 - 180 mm		1032
2	pinze becchi piegati per anelli elastici, per fori Ø 130 - 170 mm		1034

N. pezzi/Descrizione

2	pinze becchi diritti per anelli elastici, per alberi Ø 140x1,3 - 175 mm	Beta N.	1036
2	pinze becchi piegati per anelli elastici, per alberi Ø 135x1,3 - 175 mm		1038
1	pinze regolabili cerniera chiusa 250 mm		1048
1	pinza autobloccante a doppia regolazione		1051
1	tronchesi a grande effetto taglienti diagonali 160 mm		1084BM
1	tronchesi doppia leva taglio frontale 180 mm		1092V
1	cesoia a lame larghe diritte 250 mm		1112
1	cesoia a lame strette diritte 250 mm		1114
1	forbici per elettricisti lame diritte		1128BMX
1	pinza universale 180 mm		1150BM
1	pinza a becchi mezzotondi diritti Ø 160 mm		1166BM
1	pinza a becchi mezzotondi piegati Ø 200 mm		1168BM
7	giravite lama piatta Ø 3x75 - 3,5x100 - 4x125 - 5,5x150 - 6,5x150 - 10x200 - 12x250 mm		1260
1	giravite lama piatta con esagono di manovra Ø 12x200 mm		1260E
3	giravite per viti con impronta a croce Phillips® ⚙ PH0x60 - PH1x80 - PH2x100 mm		1262
2	martello tipo tedesco 300 - 600 g		1370
1	mazzuola con battenti in materiale plastico Ø 35 mm		1390
11	estrattori a rulli per viti prigioniere 6÷12 mm		1433/C11
1	chiave regolabile a nastro per filtri olio		1491
1	provatensione		1498
1	flessometro 5 m		1692
1	spessimetro		1708/20
1	flessibile magnetico 1,8 kg		1712E/2
1	raschietto a due taglienti 200 mm		1717A
1	raschietto a tre taglienti 200 mm		1717B
5	lime a taglio mezzodolce 200 mm		1719BMA/S5
1	seghetto		1725
1	oliatore in metallo a pressione 200 cc		1751
1	cutter con lama a settori		1771

5957VG € 2.660,00 059570028

5700A GVG (C57A G+5957VG)

€ 5.880,00 057000397

5700B RVG (C57B R+5957VG)

€ 6.480,00 057000599

5700A OVG (C57A O+5957VG) € 5.880,00 057000197

5700B GVG (C57B G+5957VG)

€ 6.480,00 057000399

5700B OVG (C57B O+5957VG) € 6.480,00 057000199

5700A RVG (C57A R+5957VG)

€ 5.880,00 057000597

Termoformati morbidi serie MC



Assortimenti di utensili in termoformato per i modelli di cassettiere C22S, C23S, C23SC.

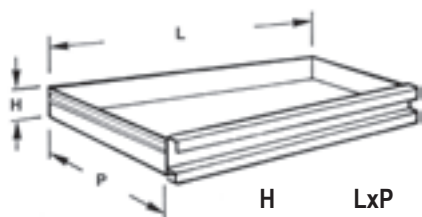

H mm	LxP mm
70	588x257

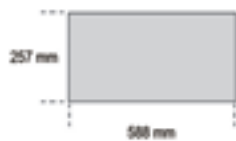

MC10



42 6-7-8-9-10-11-12
13-14-15-16-17
18-19-20-21 mm

3,1 kg

MC10	€ 157,00	1	023500010
MCV10	€ 24,00	1	023510010

MC82



12 920A 10-11-12-13-14-15
16-17-18-19-20-21
22-23-24-26-27
30-32 mm
920AN/125 150 mm
920/25
920/42 305 mm
920/55

3,1 kg

12"

MC82	€ 249,50	1	023500082
MCV82	€ 24,00	1	023510082

MC91



14 900A 4-4,5-5-5,5-6
7-8-9-10-11
12-13-14 mm
900ME 2,5-3-4-5-6-8 mm
900/20 50 mm
900/21 150 mm
900/25
900BG/30
900/42 115 mm
900/55

700 g

14"

MC91	€ 173,50	1	023500091
MVC91	€ 24,00	1	023510091

MC131



1084BM 160 mm
1150BM 180 mm
1166BM 160 mm

750 g

MC131	€ 79,50	1	023500131
MCV131	€ 24,00	1	023510131

MC153



96/SC9 1,5+10 mm
1048 250 mm
1370 300 g
1692/5 5 m

980 g

MC153	€ 70,50	1	023500153
MCV153	€ 24,00	1	023510153

MC220



12 1201 3x75
4x100
5,5x150
6,5x150 mm
1202 PH0x60
PH1x80
PH2x100 mm

530 g

MC220	€ 30,50	1	023500220
MCV220	€ 24,00	1	023510220

Termoformati morbidi serie M

Assortimenti di utensili in termoformato per tutti i modelli di cassettiere e per i carrelli.

Per maggior chiarezza indichiamo le altezze dei cassettei C1 e C2 alle quali si deve fare riferimento per la scelta del termoformato completo di utensili. A fianco di ogni termoformato è indicato con quale altezza di cassetto è compatibile.

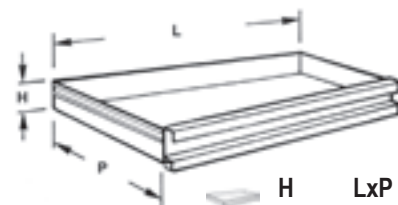

H mm	LxP mm
C1 50	588x367
C2 70	588x367

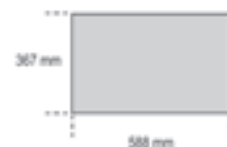
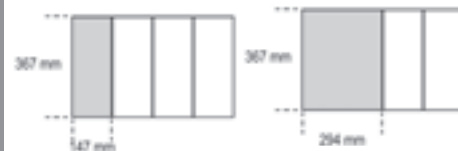

M15



42 6-7-8-9-10-11-12
13-14-15-16-17
18-19-20-21 mm

1,5 kg

M15	€ 157,00	1	024500015
MV15	€ 21,00	1	024510015

M16

42 22-24-27-30-32 mm

1,1 kg

C2

M16	€ 108,00	1	024500016
MV16	€ 28,00	1	024510016

M45142 8-9-10-11-12
13-14-15-16
17-18-19 mm

1,3 kg

C2

M45	€ 231,50	1	024500045
MV45	€ 21,00	1	024510045

M63

952 7-8-10-12-13-14-17-19 mm

3,4 kg

C1-C2

M63	€ 241,00	1	024500063
MV63	€ 37,00	1	024510063

M3355 6x7-8x9-10x11
12x13-14x15
16x17-18x19
20x22 mm
96/SC9 1,5+10 mm

1,1 kg

C2

M33	€ 68,00	1	024500033
MV33	€ 21,00	1	024510033

M46142SN 8-9-10-11-12
13-14-15-16
17-18-19 mm

1,4 kg

C2

M46	€ 272,00	1	024500046
MV46	€ 21,00	1	024510046

M69951 2,5-3-4-5-6-8
10-12-14 mm

1,8 kg

C1-C2

M69	€ 208,50	1	024500069
MV69	€ 28,00	1	024510069

M3855 21x23-24x26
27x29-30x32 mm

1,7 kg

C1-C2

M38	€ 57,50	1	024500038
MV38	€ 28,00	1	024510038

M5096T 2-2,5-3-4-5
6-7-8 mm

1,1 kg

C1-C2

M50	€ 87,50	1	024500050
MV50	€ 28,00	1	024510051

M75933 7-8-9-10-11-12-13-14-15
16-17-18-19-21-22-24 mm

5,5 kg

C2

M75	€ 326,00	1	024500075
MV75	€ 37,00	1	024510075

M4090 6x7-8x9-10x11
12x13-14x15
16x17-18x19 mm

810 g

C2

M40	€ 76,00	1	024500040
MV40	€ 21,00	1	024510040

M55

97TTX T10-T15-T20-T25-T30

330 g

C1-C2

M55	€ 58,00	1	024500055
MV55	€ 21,00	1	024510055

M7980 8x9-10x11-12x13
-14x15 16x17-18x19
mm

1,3 kg

C2

M79	€ 215,00	1	024500079
MV79	€ 21,00	1	024510079

M82



- 920A 10-11-12-13-14
15-16-17-18-19
20-21-22-23-24
26-27-30-32 mm
- 920/ME 5-6-8-10-12 mm
- 920AN/125 125 mm
- 920AN/250 250 mm
- 920/25
- 920/42
- ⊕ 920/55

4,1 kg

12"

C2



M82	€ 339,00	1	024500082
MV82	€ 28,00	1	024510082

M83



- 920A 10-11-12-13-14
15-16-17-18-19
20-21-22-23-24
26-27-30-32 mm
- 920AN/125 125 mm
- 920AN/250 250 mm
- 920/25 255 mm
- 920/42
- ⊕ 920/55

3,7 kg

12"

C2



M83	€ 275,00	1	024500083
MV83	€ 28,00	1	024510083

M85



- 851
- 860LP 0,5x3 - 0,6x4,5
- 0,8x5,5 - 1x5,5 -
1,2x6,5 mm
- 860PE 2 - 2,5 - 3 - 4 - 5 - 6 - 8
- 10 mm
- ⊕ 860PH PH0 - PH1 - PH2 -
PH3 - PH4
- ⊕ 860PZ PZ1 - PZ2 - PZ3 - PZ4
- ⊕ 860TX T6-T7-T8-T9-T10-T15-
T20-T25-T27-T30-T40
- ⊕ 860RTX T9-T10-T15-T20-T25-
T27-T30-T40
- 860/55
- 882P

450 g

1/4"

C1-C2



M85	€ 139,00	1	024500085
MV85	€ 21,00	1	024510085

Beta

M86



- 867PE 4-5-6-7-8-10-12 mm
- 867PE/L 4-5-6-7-8-10-12 mm
- 867XZN 5-6-8-10-12 mm
- 867XZN/L 5-6-8-10-12 mm
- ⊕ 867TX T20-T25-T30-T40-
T45-T50-T55
- ⊕ 867TX/L T25-T30-T40-T45-
T50-T55
- ⊕ 867RTX T20-T25-T30-T40-
T45-T50-T55
- 867/1
- 867/2

1,4 kg

10"

C1-C2



M86	€ 91,50	1	024500086
MV86	€ 21,00	1	024510086

M91



- 900 4-4,5-5-5,5-6-7-8-9-
10-11-12-13-14 mm
- 900ME 2,5-3-4-5-6-8 mm
- 900/20 50 mm
- 900/21 150 mm
- 900/25 □ 1/4 - ■ 1/4
- 900BG/30
- 900/42
- ⊕ 900/55

560 g

1/4"



M91	€ 173,50	1	024500091
MV90	€ 21,00	1	024510090

M92



- 910A 6-7-8-9-10-11-12-13-
14-15-16-17-18-19-20-
21-22 mm
- 910/21 125 mm
- 910/22 250 mm
- 910/25
- 910/42
- ⊕ 910/55

1,5 kg

3/8"

C2



M92	€ 207,50	1	024500092
MV92	€ 21,00	1	024510092

M112



- ⊕ 861TX ● 1/4-T6+T15
- ⊕ 866TX ● 5/16-T20+T55
- 895/1 ○ 1/4x□1/4
- 895/6 ○ 5/16x□1/2
- ⊕ 900FTX □ 1/4-E4+E10
- ⊕ 920FTX □ 1/2-E12+E24
- ⊕ 920TX □ 1/2-T55L-T60-T70L

1,3 kg

14" 12"

C2



M112	€ 228,00	1	024500112
MV112	€ 21,00	1	024510112

M131



- ⊕ 1084BM 160 mm
- ⊕ 1150BM 180 mm
- 1166BM 160 mm

750 g

C1-C2



M131	€ 79,50	1	024500131
MV131	€ 21,00	1	024510131

M132



- ⊕ 1084 160 mm
- ⊕ 1150 180 mm
- 1166 160 mm

650 g

C1-C2



M132	€ 62,50	1	024500132
MV132	€ 21,00	1	024510132

M135



- ⊕ 1082MQ 160 mm
- ⊕ 1150MQ 180 mm
- 1166MQ 160 mm

750 g

C1-C2



M135	€ 116,00	1	024500135
MV135	€ 21,00	1	024510135

Beta

M145

- 1032 180 mm
- 1034 170 mm
- 1036 175 mm
- 1038 175 mm

640 g

C1-C2

M145	€ 90,50	1	024500145
MV145	€ 21,00	1	024510145

M174

- 1297TX T8-T10-T15-T20-T25-T30

450 g

C1-C2

M174	€ 72,00	1	024500174
MV174	€ 21,00	1	024510174

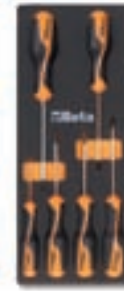
M204

- 1267TX T8-T10-T15-T20-T25-T30

450 g

C1-C2

M204	€ 55,00	1	024500204
MV204	€ 21,00	1	024510204

M153

- 1048 250 mm
- 1052 240 mm

1 kg

C1-C2

M153	€ 55,50	1	024500153
MV153	€ 21,00	1	024510153

M180

- 1290 3x75
4x100
5.5x150
6.5x150 mm
- 1292 PH0x60
PH1x80
PH2x100 mm

500 g

C1-C2

M180	€ 52,50	1	024500180
MV180	€ 21,00	1	024510180

M208

- 1260 3x75
3.5x100
4x125
5.5x150
6.5x150 mm
- 1262 PH0x60
PH1x80
PH2x100 mm
- 1260N 4x30 mm
- 1262N PH1x30 mm

750 g

C1-C2

M208	€ 59,50	1	024500208
MV208	€ 28,00	1	024510208

M170

- 1290 2.5x50
3x75
3.5x100
4x125
5.5x100
5.5x150
6.5x150 mm

500 g

C1-C2

M170	€ 50,50	1	024500170
MV170	€ 21,00	1	024510170

M199

- 1260 2.5x50
3x75
3.5x100
4x125
5.5x100
5.5x150
6.5x150 mm

500 g

C1-C2

M199	€ 40,50	1	024500199
MV199	€ 21,00	1	024510199

M220

- 1201 3x75
4x100
5.5x150
6.5x150 mm
- 1202 PH0x60
PH1x80
PH2x100 mm

500 g

C1-C2

M220	€ 30,50	1	024500220
MV220	€ 21,00	1	024510220

M172

- 1292 PH0x60
PH0x100
PH1x80
PH1x120
PH2x100
PH2x150 mm

450 g

C1-C2

M172	€ 46,50	1	024500172
MV172	€ 21,00	1	024510172

M202

- 1262 PH0x60
PH0x100
PH1x80
PH1x120
PH2x100
PH2x150 mm

450 g

C1-C2

M202	€ 37,50	1	024500202
MV202	€ 21,00	1	024510202

M226

- 1274MQ 3x100
4x100
5.5x125
6.5x150 mm
- 1272MQ PH0x60
PH1x80
PH2x100 mm

500 g

C1-C2

M226	€ 65,50	1	024500226
MV226	€ 21,00	1	024510226

M227



○ 944BX 6-7-8-10-13 mm

📦 420 g

C1-C2



M227	€ 88,00	1	024500227
MV227	€ 21,00	1	024510227

M234



35 100-200 mm
1370 300 g
1390 Ø 35 mm

📦 1,3 kg

C1-C2



M234	€ 65,00	1	024500234
MV232	€ 21,00	1	024510232

M236



■ 1719BMA/Q 200 mm
▲ 1719BMA/T 200 mm
■ 1719BMA/P 200 mm
▶ 1719BMA/M 200 mm
● 1719BMA/R 200 mm

📦 870 g

C1 - C2



M236	€ 67,00	1	024500236
MV236	€ 21,00	1	024510236

M237



35 100-200 mm
1370T 300 mm
1390N Ø 35 mm

📦 1,3 kg

C1-C2



M237	€ 73,00	1	024500237
MV232	€ 21,00	1	024510232

M240



31BM Ø 2-3-4-5-6-8 mm
32 Ø 4 mm

📦 850 g

C1-C2



M240	€ 93,50	1	024500240
MV240	€ 21,00	1	024510240

M264



1491 Ø 65÷110 mm
■ 1494 ■ 10 mm
○ 1494E ○ 8-9-10-11-12-14-17 mm
○ 1494Q ○ 8-9,5-12-13 mm
△ 1494T △ 9,5
○ 1494XZN ○ 16
1496C ■ 8x ■ 10 mm

📦 2,1 kg

C2



M264	€ 152,00	1	024500264
MV264	€ 21,00	1	024510264

M285



1112 250 mm
1128BM
1726 440 mm
1728BM (5)
1753 200 cc

📦 1,5 kg

C2



M285	€ 82,50	1	024500285
MV285	€ 37,00	1	024510285

M289



1692 5 m
1725CR
1755 30 cc
1771

📦 500 g

C2



M289	€ 33,00	1	024500289
MV289	€ 21,00	1	024510289

M300



1927A
○ 720 12-13-14-15-16-17
18-19-21-22
24-27 mm
720/21

📦 4,7 kg

12"

C2



M300	€ 366,00	1	024500300
MV300	€ 28,00	1	024510300

M310



1927CD
○ 720 12-13-14-15-16-17
18-19-21-22
24-27 mm
720/21

📦 4,0 kg

12"

C2



M310	€ 527,00	1	024500310
MV310	€ 28,00	1	024510310

VPM3

termoformato morbido
con 3 vaschette portaminuterie



VPM3	€ 11,50	1	088870353
------	---------	---	-----------

VPM0

termoformato morbido
con vaschetta portaminuterie



VPM0	€ 11,50	1	088870350
------	---------	---	-----------

Termoformati rigidi serie T



Assortimenti di utensili in termoformato per tutti i modelli di cassettiere e per i carrelli.

Per maggior chiarezza indichiamo le altezze dei cassetti C1 e C2 alle quali si deve fare riferimento per la scelta del termoformato completo di utensili. A fianco di ogni termoformato è indicato con quale altezza di cassetto è compatibile.

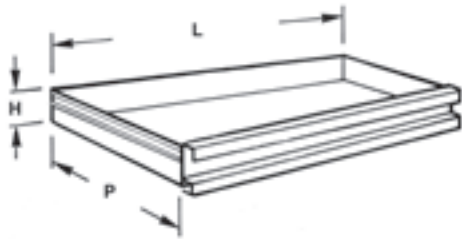

	H mm	LxP mm
C1	50	588x367
C2	70	588x367

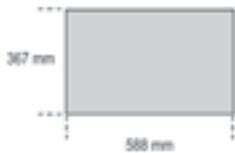
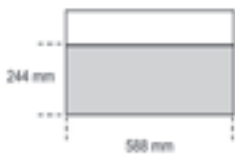
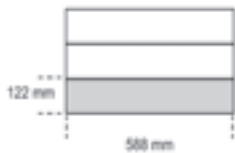
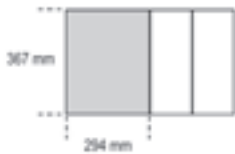
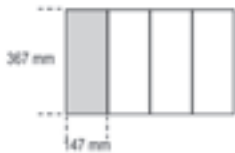

T10



42 6-7-8-10-11-12-13
14-16-17-18-19-21
22-24-27-30 mm

2,7 kg

C2



T10	€ 194,00	1	024240010
TV10	€ 21,00	1	024000400

T15



42 6-7-8-9-10-11-12
13-14-15-16-17
18-19-20-21 mm

1,5 kg

C2



T15	€ 149,50	1	024240015
TV15	€ 15,50	1	024000445

T16



42 22-24-27-30-32 mm

2,1 kg

C2



T16	€ 103,00	1	024240016
TV16	€ 15,50	1	024000446

T18



42MP 6-7-8-9-10-11-12
13-14-15-16-17
18-19-20-21 mm

1,5 kg

C2



T18	€ 200,50	1	024240018
TV15	€ 15,50	1	024000445

T19



42MP 22-24-27-30-32 mm

2,1 kg

C2



T19	€ 132,50	1	024240019
TV16	€ 15,50	1	024000446

T22



42AS 5/16-3/8-7/16-1/2
9/16-5/8-11/16-3/4
3/32-1/8-5/32-3/16
1/4-5/16-3/8

1 kg

C2



T22	€ 109,00	1	024240022
TV20	€ 15,50	1	024000488

T31



31 Ø 2-3-4-5-6 mm
32 Ø 4 mm
55 6x7-8x9-10x11
12x13-14x15
16x17-18x19
20x22-21x23
24x26-27x29
30x32 mm
○ 96N/SC9 1,5+10 mm

3 kg

C2



T31	€ 156,00	1	024240031
TV30	€ 21,00	1	024000401

T33



55 6x7-8x9-10x11
12x13-14x15
16x17-18x19
20x22 mm
○ 96/SC9 1,5+10 mm

1 kg

C2



T33	€ 65,00	1	024240033
TV20	€ 15,50	1	024000488

T34

55MP 6x7-8x9-10x11
12x13-14x15
16x17-18x19
20x22 mm
○96/SC9 1,5±10 mm

1 kg

C2

T34	€ 84,50	1	024240034
TV20	€ 15,50	1	024000488

T46

142SN 8-9-10-11-12
13-14-15-16
17-18-19 mm

1,5 kg

C2

T46	€ 267,00	1	024240046
TV46	€ 15,50	1	024000499

T53

○96TBP 2,5-3-4-5-6 mm

300 g

C1 - C2

T53	€ 52,00	1	024240053
TV52	€ 15,50	1	024000765

T40

90 6x7-8x9-10x11
12x13-14x15
16x17-18x19 mm

810 g

C2

T40	€ 73,00	1	024240040
TV40	€ 15,50	1	024000456

T48

○96BPC/SC9 1,5±10 mm
142C 8-9-10-11-12
13-14-15-16
17-18-19 mm

1,4 kg

C2

T48	€ 192,00	1	024240048
TV47	€ 15,50	1	024000763

T55

○97TTX T10-T15-T20
T25-T27-T30

330 g

C1 - C2

T55	€ 68,50	1	024240055
TV55	€ 15,50	1	024000766

T41

90 20x22-21x23
24x26-25x28
27x29 mm

1,5 kg

C2

T41	€ 104,50	1	024240041
TV41	€ 15,50	1	024000457

T50

○96T 2-2,5-3-3,5-4-4,5
5-6-7-8-10 mm

1,3 kg

C1 - C2

T50	€ 118,50	1	024240050
TV50	€ 21,00	1	024000764

T56

○96BP 2-3-4-5-6-8-10 mm
○97TX T20-T25-T30-T40-
T45-T50-T55

300 g

C1 - C2

T56	€ 89,00	1	024240056
TV56	€ 15,50	1	024249901

T45

142 8-9-10-11-12
13-14-15-16
17-18-19 mm

1,3 kg

C2

T45	€ 224,00	1	024240045
TV45	€ 15,50	1	024000498

T52

○96T 2-2,5-3-4-5-6 mm

350 g

C1 - C2

T52	€ 59,00	1	024240052
TV52	€ 15,50	1	024000765



T59



- 111 250 mm
- 920/40 ■ 1/2
- 951 2,5-3-4-5-6-8 mm
- 953 4-5-6-8 mm
- 1370 300 - 500 g

4,7 kg

C2

T59	€ 303,00	1	024240059
TV60	€ 33,00	1	024000420

T63



952 7-8-10-12-13-14-17-19 mm

3,8 kg

C1 - C2

T63	€ 234,50	1	024240063
TV63	€ 29,00	1	024000471

T64



- 952FTX E10-E12-E14
- 953TX T25-T27-T30-T40-T45

3,8 kg

C1 - C2

T64	€ 287,00	1	024240064
TV63	€ 29,00	1	024000471

T65



953 3-3,5-4-5-6-7-8-10 mm

2,8 kg

C1 - C2

T65	€ 217,50	1	024240065
TV63	€ 29,00	1	024000471

T68



951 2,5-3-4-5-6-8 mm

590 g

C1 - C2

T68	€ 100,50	1	024240068
TV68	€ 15,50	1	024000470

T73



930 6x7-8x9-10x11-12x13-14x15-16x17-18x19-20x22 mm

940/1

940/2

1,3 kg

C2

T73	€ 143,50	1	024240073
TV73	€ 15,50	1	024000418

T75



933 7-8-9-10-11-12-13-14-15-16-17-18-19-21-22-24 mm

4,2 kg

C2

T75	€ 318,00	1	024240075
TV75	€ 33,00	1	024000422

T76



932 7-8-9-10-11-12-13-14-15-16-17-18-19-21-22-24 mm

4,2 kg

C2

T76	€ 318,00	1	024240076
TV75	€ 33,00	1	024000422

T77



933 6-7-8-10-11-12-13-14-17-19 mm

1,4 kg

C2

T77	€ 160,00	1	024240077
TV77	€ 15,50	1	024000474

T79



80 8x9-10x11-12x13-14x15-16x17-18x19 mm

1,3 kg

C2

T79	€ 206,50	1	024240079
TV79	€ 15,50	1	024000490



T80



- 920A 10-11-12-13-14
15-16-17-18-19
20-21-22-23-24
26-27-30-32 mm
- 920ME 5-6-8-10-12 mm
- 920/21 125 mm
- 920/22 255 mm
- 920/25 305 mm
- 920/42 305 mm
- Ⓢ 920/55

4,1 kg

12"

C2



T80	€ 318,00	1	024240080
TV80	€ 21,00	1	024000403

T85



- 861LP 0,5x3 - 0,6x4,5 - 0,8x5,5 - 1x5,5 - 1,2x6,5 - 1,2x8 - 1,6x8 mm
- 861PE 2 - 2,5 - 3 - 4 - 5 - 6 - 8 - 10 mm
- ⊕ 861PH PH0 - PH1 - PH2 - PH3
- ⊕ 861PZ PZ1 - PZ2 - PZ3
- ⊕ 861TX T6-T7-T8-T9-T10-T15-T20-T25-T27-T30-T40
- ⊕ 861RTX T9-T10-T15-T20-T25-T27-T30-T40
- ⊕ 861TRW 1-2-3-4-5-6 mm
- ⊕ 861TQS 0-1-2-3-4-5-6-8 mm
- ⊕ 861SP 4-6-8-10-12 mm
- 851SR 230 mm
- 900 4-4,5-5-5,5-6-7-8-9
10-11-12-13-14 mm
- 900/21 150 mm
- 900/25 41 mm
- 900BG/30 176 mm
- 900/42 115 mm
- Ⓢ 900/55 125 mm
- 194 1/4x5/16

1,0 kg

14"

C1 - C2



T85	€ 253,00	1	024240085
TV85	€ 21,00	1	024000747

T100



- 920A 10-12-13-14-15
16-17-18-19-21
22-24 mm
- 920/21 125 mm
- 920/25 305 mm
- 920/42 305 mm
- Ⓢ 920/55

2,1 kg

12"

C2



T100	€ 178,00	1	024240100
TV100	€ 15,50	1	024000495

T81



- 920B 10-11-12-13-14
15-16-17-18-19
20-21-22-23-24
26-27-30-32 mm
- 920ME 5-6-8-10-12 mm
- 920/21 125 mm
- 920/22 255 mm
- 920/25 305 mm
- 920/42 305 mm
- Ⓢ 920/55

4,1 kg

12"

C2



T81	€ 318,00	1	024240081
TV80	€ 21,00	1	024000403

T101



- 920B 10-12-13-14-15
16-17-18-19-21
22-24 mm
- 920/21 125 mm
- 920/25 305 mm
- 920/42 305 mm
- Ⓢ 920/55

2,1 kg

12"

C2



T101	€ 178,00	1	024240101
TV100	€ 15,50	1	024000495

T82



- 920A 10-11-12-13-14
15-16-17-18-19
20-21-22-23-24
26-27-30-32 mm
- 920ME 5-6-8-10-12 mm
- 920AN/125 125 mm
- 920AN/250 250 mm
- 920/25 305 mm
- 920/42 305 mm
- Ⓢ 920/55

4,1 kg

12"

C2



T82	€ 331,00	1	024240082
TV80	€ 21,00	1	024000403

T91



- 900 4-4,5-5-5,5-6
7-8-9-10-11
12-13-14 mm
- 900ME 2,5-3-4-5-6-8 mm
- 900/20 50 mm
- 900/21 150 mm
- 900/25 115 mm
- 900BG/30 176 mm
- 900/42 115 mm
- Ⓢ 900/55

560 g

14"

C1 - C2



T91	€ 165,00	1	024240091
TV90	€ 15,50	1	024000447

T102



- 920AS 3/8-7/16-1/2
9/16-5/8-11/16
3/4-13/16-7/8
15/16-1.1/16
- 920/21 125 mm
- 920/25 305 mm
- 920/42 305 mm
- Ⓢ 920/55

2,1 kg

12"

C2



T102	€ 193,50	1	024240102
TV100	€ 15,50	1	024000495

T83



- 920A 10-11-12-13-14
15-16-17-18-19
20-21-22-23-24
26-27-30-32 mm
- 920/21 125 mm
- 920/22 255 mm
- 920/25 305 mm
- 920/42 305 mm
- Ⓢ 920/55

3,6 kg

12"

C2



T83	€ 251,00	1	024240083
TV83	€ 21,00	1	024000402

T92



- 910A 6-7-8-9-10-11-12-13
14-15-16-17-18-19
20-21-22 mm
- 910/21 125 mm
- 910/22 250 mm
- 910/25 210 mm
- 910/42 210 mm
- Ⓢ 910/55

1,5 kg

3/8"

C2



T92	€ 198,50	1	024240092
TV92	€ 15,50	1	024000458

T103



- 900L 6-7-8-9-10-11-12 mm
- 920AL 13-14-16-17-18-19
21-22-24-27 mm

1,1 kg

14"

12"

C1 - C2



T103	€ 233,50	1	024240103
TV103	€ 15,50	1	024000748

T105



○ 928A 22-24-27-30-32-34
36-38-41-46-50 mm

4,9 kg

3/4"

C2

€ 223,00
15,00

1 024240105
1 024000484

T105
TV105

T113



○ 920PE 5L-6L-7L-8L-10L
○ 920TX T40L-T45L
T55L-T70L
○ 920XZN M6L-M8L-M12L

1,5 kg

12"

C2

€ 198,50
15,50

1 024240113
1 024000489

T113
TV113

T135



◁ 1082MQ 160 mm
≡ 1150MQ 180 mm
● 1166MQ 160 mm

750 g

△ 1000 V

C1 - C2

€ 110,50
15,50

1 024240135
1 024000762

T135
TV135

T106



928/21 200 mm
928/22 380 mm
928/42 450 mm
928/55

4,5 kg

3/4"

C2

€ 222,50
15,00

1 024240106
1 024000485

T106
TV106

T120



606/20 40-200 Nm

1,1 kg

12"

C2

€ 191,50
15,00

1 024240120
1 024000483

T120
TV120

T136



1048MQ 250 mm
1777MQ/U

700 g

C1-C2

€ 72,50
15,50

1 024240136
1 024000438

T136
TV136

T110



○ 720 10-11-12-13-14
16-17-18-19-21
22-23-24 mm
720/21 125 mm

1,8 kg

12"

C2

€ 177,00
15,50

1 024240110
1 024000477

T110
TV110

T131



◁ 1084BM 160 mm
≡ 1150BM 180 mm
● 1166BM 160 mm

750 g

C1 - C2

€ 76,50
15,50

1 024240131
1 024000451

T131
TV130

T140



○ 1032 140x0,9 - 180 mm
○ 1034 170 mm
● 1036 140x1,3 - 175 mm
● 1038 175 mm
◁ 1084 160 mm
1128BM

1,1 kg

C1 - C2

€ 160,00
21,00

1 024240140
1 024000405

T140
TV140

T112



○ 861TX ● 1/4-T6+T15
○ 866TX ● 5/16-T20+T55
895/1 ○ 1/4x□1/4
895/6 ○ 5/16x□1/2
○ 900FTX □ 1/4-E4+E10
○ 920FTX □ 1/2-E12+E24
○ 920TX □ 1/2-T55L-T60-T70L

1,3 kg

14" 12"

C2

€ 220,50
15,50

1 024240112
1 024000480

T112
TV112

T132



◁ 1084 160 mm
≡ 1150 180 mm
● 1166 160 mm

650 g

C1 - C2

€ 60,00
15,50

1 024240132
1 024000451

T132
TV130

T142



1048 250 mm
1052 240 mm
1112 250 mm
≡ 1150 180 mm

1,8 kg

C1 - C2

€ 95,50
21,00

1 024240142
1 024000409

T142
TV143

T145



- 1032 180 mm
- 1034 170 mm
- 1036 175 mm
- 1038 175 mm

640 g

C1 - C2



T145	€ 86,50	1	024240145
TV145	€ 15,50	1	024000448

T146



- 1032 140x0,9 mm
- 1032 225 mm
- 1036 140x1,3 mm
- 1036 225 mm

700 g

C1 - C2



T146	€ 91,00	1	024240146
TV146	€ 15,50	1	024000449

T151



- 1047 240 mm
- 1057A 240 mm

1,3 kg

C2



T151	€ 78,50	1	024240151
TV150	€ 15,50	1	024000462

T153



- 1048 250 mm
- 1052 240 mm

1,1 kg

C1 - C2



T153	€ 53,00	1	024240153
TV150	€ 15,50	1	024000462

T154



- 1082 160 mm
- 1150 180 mm
- 1048 250 mm

1 kg

C1 - C2



T154	€ 67,00	1	024240154
TV148	€ 15,50	1	024000500

T155



- 1082BM 160 mm
- 1150BM 180 mm
- 1048BM 250 mm

1,1 kg

C1 - C2



T155	€ 85,50	1	024240155
TV148	€ 15,50	1	024000500

T160



- 1290 3x75
- 3x100
- 4x100
- 4x150
- 5,5x100
- 5,5x150
- 6,5x150
- 8x150
- 10x200 mm
- 1290N 4x30
- 6,5x30 mm

1,3 kg

C1 - C2



T160	€ 90,00	1	024240160
TV160	€ 21,00	1	024000706

T161



- 1292 PH0x60
- PH0x100
- PH1x80
- PH1x120
- PH2x100
- PH2x150
- PH3x150 mm
- 1292N PH1x30
- PH2x30 mm

1 kg

C1 - C2



T161	€ 71,00	1	024240161
TV161	€ 21,00	1	024000707

T164



- 952 8-10-13-17-19 mm
- 959 16 mm (5/8") - 20,8 mm (13/16")
- 1260 3x75-4x100-5,5x100
- 6,5x150-10x200 mm
- 1262 PH0x60-PH1x80
- PH2x100-PH3x150 mm

5 kg

C1 - C2



T164	€ 319,00	1	024240164
TV61	€ 33,00	1	024000721

T167



- 1260 3x75
- 3x100
- 4x100
- 4x150
- 5,5x100
- 5,5x150
- 6,5x150
- 8x150
- 10x200 mm
- 1260N 4x30
- 6,5x30 mm

1,3 kg

C1 - C2



T167	€ 72,00	1	024240167
TV160	€ 21,00	1	024000706

T168



- 1262 PH0x60
- PH0x100
- PH1x80
- PH1x120
- PH2x100
- PH2x150
- PH3x150 mm
- 1262N PH1x30
- PH2x30 mm

1 kg

C1 - C2



T168	€ 58,00	1	024240168
TV161	€ 21,00	1	024000707



T170**BetamaX**

- 1290 2,5x50
3x75
3,5x100
4x125
5,5x100
5,5x150
6,5x150 mm

450 g

C1 - C2

T170	€ 48,50	1	024240170
TV170	€ 15,50	1	024000741

T175**BetamaX**

- 1297TX T6-T7-T8-T9
T10-T15-T20

410 g

C1 - C2

T175	€ 74,50	1	024240175
TV175	€ 15,50	1	024000760

T183**BetamaX**

- 1292L PH1x400-PH2x400 mm
- 1294L 3x300-4x400-5x400 mm

580 g

C2

T183	€ 68,00	1	024240183
TV183	€ 15,00	1	024000497

T171**BetamaX**

- 1290 8x150
8x200
10x200 mm
- 1290N 4x30
6,5x30 mm

750 g

C1 - C2

T171	€ 54,00	1	024240171
TV171	€ 15,50	1	024000742

T176**BetamaX**

- 1297TX T25-T27-T30
T40-T45

640 g

C1 - C2

T176	€ 67,50	1	024240176
TV176	€ 15,50	1	024000761

T198

- 1260 3x75
4x100
5,5x150
6,5x150 mm
- 1269PZ PZ0 - PZ1 - PZ2

490 g

C1 - C2

T198	€ 43,00	1	024240198
TV170	€ 15,50	1	024000741

T172**BetamaX**

- 1292 PH0x60
PH0x100
PH1x80
PH1x120
PH2x100
PH2x150 mm

450 g

C1 - C2

T172	€ 44,50	1	024240172
TV172	€ 15,50	1	024000743

T177**BetamaX**

- 1298RTX T9-T10-T15
T20-T25-T27
T30-T40

680 g

C1 - C2

T177	€ 103,50	1	024240177
TV177	€ 15,50	1	024000759

T199

- 1260 2,5x50
3x75
3,5x100
4x125
5,5x100
5,5x150
6,5x150 mm

490 g

C1 - C2

T199	€ 38,50	1	024240199
TV170	€ 15,50	1	024000741

T173**BetamaX**

- 1292 PH3x150
PH4x200 mm
- 1292N PH1x30
PH2x30 mm

560 g

C1 - C2

T173	€ 44,00	1	024240173
TV173	€ 15,50	1	024000744

T180**BetamaX**

- 1290 3x75
4x100
5,5x150
6,5x150 mm
- 1292 PH0x60
PH1x80
PH2x100 mm

480 g

C1 - C2

T180	€ 50,50	1	024240180
TV180	€ 15,50	1	024000701

T201

- 1260 8x200
10x150
10x200 mm
- 1260N 4x30
6,5x30 mm

680 g

C1 - C2

T201	€ 42,50	1	024240201
TV171	€ 15,50	1	024000742

T202



- 1262 PH0x60
PH0x100
PH1x80
PH1x120
PH2x100
PH2x150 mm

490 g

C1 - C2



T202	€ 36,00	1	024240202
TV172	€ 15,50	1	024000743

T207



- 1268RTX T9-T10-T15
T20-T25-T27-T30

760 g

C1 - C2



T207	€ 67,00	1	024240207
TV207	€ 15,50	1	024000758

T210



- 1201 2,5x50
3x75
3,5x100
4x125
5,5x100
5,5x150
6,5x150 mm

490 g

C1 - C2



T210	€ 28,00	1	024240210
TV170	€ 15,50	1	024000741

T204



- 1262 PH3x150
PH4x200 mm
- 1262N PH1x30
PH2x30 mm

610 g

C1 - C2



T204	€ 35,50	1	024240204
TV173	€ 15,50	1	024000744

T208



- 1260 3x75
4x100
5,5x150
6,5x150 mm
- 1262 PH0x60
PH1x80
PH2x100 mm

530 g

C1 - C2



T208	€ 41,00	1	024240208
TV180	€ 15,50	1	024000701

T212



- 1202 PH0x60
PH1x80
PH1x120
PH2x100
PH2x150
PH3x150 mm

490 g

C1 - C2



T212	€ 29,50	1	024240212
TV212	€ 15,50	1	024000440

T205



- 1267TX T6-T7-T8-T9
T10-T15-T20

460 g

C1 - C2



T205	€ 55,00	1	024240205
TV175	€ 15,50	1	024000760

T209



- 1262L PH1x400-PH2x400 mm
- 1264L 3x300-4x400-5x400 mm

580 g

C2



T209	€ 52,00	1	024240209
TV183	€ 15,00	1	024000497

T215



- 1207TX T6-T7-T8-T9
T10-T15-T20

410 g

C1 - C2



T215	€ 41,00	1	024240215
TV175	€ 15,50	1	024000760

T206



- 1267TX T25-T27-T30
T40-T45

710 g

C1 - C2



T206	€ 54,00	1	024240206
TV176	€ 15,50	1	024000761

T220



- 1201 3x75
4x100
5,5x150
6,5x150 mm
- 1202 PH0x60
PH1x80
PH2x100 mm

530 g

C1 - C2



T220	€ 29,50	1	024240220
TV180	€ 15,50	1	024000701



T226

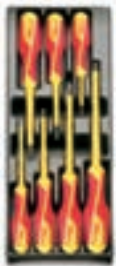

- 1274MQ 3x100
4x100
5,5x125
6,5x150 mm
- ⊕ 1272MQ PH0x60
PH1x80
PH2x100 mm

△1000 V

460 g



T226	€ 63,00	1	024240226
TV180	€ 15,50	1	024000701

T234



- 35 100-200 mm
- 1370 300 g
- 1390 Ø 35 mm

1,3 kg



T234	€ 62,50	1	024240234
TV232	€ 15,50	1	024000452

T227



- 944BX 5-6-7-8-10-13 mm

490 g



T227	€ 97,00	1	024240227
TV227	€ 15,50	1	024000705

T236



- 1719BMA/Q 200 mm
- ▲ 1719BMA/T 200 mm
- ▮ 1719BMA/P 200 mm
- ▷ 1719BMA/M 200 mm
- 1719BMA/R 200 mm

870 g



T236	€ 64,50	1	024240236
TV235	€ 15,50	1	024000453

T231



- 1370 400 g
- 1390 Ø 35 mm
- ▲ 1719BMA/T 200 mm
- ▮ 1719BMA/P 200 mm
- ▷ 1719BMA/M 200 mm

1,7 kg



T231	€ 77,00	1	024240231
TV230	€ 21,00	1	024000411

T239



- 31BM Ø 2-3-4-5-6-8 mm
- 32 Ø 4 mm

850 g



T239	€ 89,00	1	024240239
TV239	€ 15,50	1	024000439

T233



- 35 100-200 mm
- 1370F 32 mm
- 1390 Ø 35 mm

1,3 kg



T233	€ 71,50	1	024240233
TV232	€ 15,50	1	024000452

Beta

T241



- 1500N/1
- 1500N/3
- 1516/1

4,2 kg



T241	€ 198,00	1	024240241
TV241	€ 21,00	1	024000414

T250

Automotive



- 34 150 mm
- 83/S3 11x13-14x17
19x22 mm
- 1458 175 mm
- 1491
- 1603
- 1708/13 0,05±1 mm

1430 g



T250	€ 173,50	1	024240250
TV250	€ 21,00	1	024000408

T256

Automotive



- 956E 16 mm (5/8) - 20,8 mm (13/16)
- 956L 16 mm (5/8) - 20,8 mm (13/16)
- 959 16 mm (5/8) - 20,8 mm (13/16)
- 1164 200 mm
- 1708/20 0,05±1 mm

3,2 kg



T256	€ 286,00	1	024240256
TV256	€ 29,00	1	024000467

T259



- 96BP 2,5-3-4-5
6-8-10 mm
- 96N 12 mm
- 860MIX/A31
-
- ⊕
- ⊕
- ⊕
- 895/1

950 g

C2

T259	€ 107,00	1	024240259
TV263	€ 15,50	1	024000492

T264



- 1491 Ø 65+110 mm
- 1494 ■ 10 mm
- 1494E ○ 8-9-10-11-12-14-17 mm
- 1494Q □ 8-9,5-12-13 mm
- △ 1494T △ 9,5
- 1494XZN ○ 16
- 1496C ■ 8x ■ 10 mm

2,1 kg

C2

T264	€ 144,50	1	024240264
TV261	€ 15,50	1	024000466

T270



- 430 M3 - 4 - 5 - 6 - 7 - 8 - 9
10 - 12 - 14 - 16 - 18 - 20
- 433 M6x0,75 - M8x1 - M10x1,25
M12x1,5 - M14x1,5
M16x1,5 - M18x1,5
- 440 M3 - 4 - 5 - 6 - 7 - 8 - 9
- 440A M10 - 12 - 14 - 16 - 18 - 20
- 441 M6x0,75 - M8x1,0
- 441A M10x1,25 - M12x1,5
M14x1,5 - M16x1,5
M18x1,5

4,3 kg

C2

T270	€ 360,00	1	024240270
TV270	€ 21,00	1	024000481

T273



- 435/1,5 M3+M12
- 435/3 M5+M21
- 436/1 □ 2,0+5,0 mm
(M3+M8)
- 436/2 □ 4,6+8 mm
(M5+M12)
- 444/1 Ø 25,4 mm
- 444/2 Ø 38,1 mm
- 1707 W 62+4x1"

2,1 kg

C2

T273	€ 156,50	1	024240273
TV272	€ 21,00	1	024000482

T281



- 1741B 250 mm
- 1741RV2,9K 2,9x6 mm (100)
- 1741RV3,2K 3,2x8 mm (100)
- 1741RV3,8K 3,8x10 mm (100)
- 1741RV4K 4x12 mm (100)

1,4 kg

C2

T281	€ 49,00	1	024240281
TV280	€ 15,50	1	024000478

T285



- 1112 250 mm
- 1128BM -
- 1726 400 mm
- 1728BM (5)
- 1753 200 cc

1,5 kg

C2

T285	€ 79,50	1	024240285
TV285	€ 29,00	1	024000487

T286



- 1128BMX
- 1130BMX
- 1719BMA/S5 200 mm
- 1726BM 400 mm
- 1728BM
- 1778M 185 mm
- 1771 170 mm

2,9 kg

C2

T286	€ 180,00	1	024240286
TV286	€ 33,00	1	024249904

T289



- 1692 5 m
- 1725CR -
- 1755 30 cc
- 1771 -

500 g

C2

T289	€ 32,00	1	024240289
TV290	€ 15,50	1	024000455

T291



- 1479RB/1
- 1479RB/2
- 1479RB/3

600 g

C2

T291	€ 86,00	1	024240291
TV291	€ 15,50	1	024000472

T296



1651DGT
1682 300 mm
1691BG 5 m

490 g

C1 - C2



T296	€ 121,00	1	024240296
TV296	€ 15,50	1	024000749

VP1 - VP2

termoformati portaminuterie in materiale plastico per tutti i modelli di cassettiere: C22S, C23S, C23SC

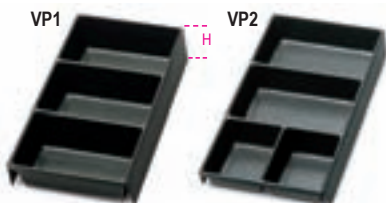

C1-C2



VP1	H mm 50	€ 7,20	1	088880351
VP2	H mm 35	€ 7,20	1	088880352

VP3 - VP4

termoformati portaminuterie in materiale plastico per tutti i modelli di cassettiere e per i carrelli

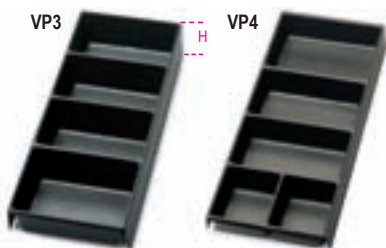

C1-C2



VP3	H mm 50	€ 8,30	1	088880353
VP4	H mm 35	€ 8,30	1	088880354

VP5

termoformato



C2



VP5	€ 11,30	1	088880355
-----	---------	---	-----------

VP6

termoformato



C2



VP6	€ 11,30	1	088880359
-----	---------	---	-----------

VP-3SC

termoformati portaminuterie in materiale plastico per cassetteria C38

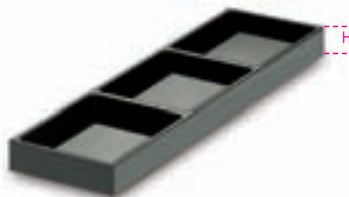

VP-3SC	H mm 45	€ 12,00	1	088880356
--------	---------	---------	---	-----------

VP-LS

termoformati portaminuterie in materiale plastico per cassetteria C38



VP-LS	H mm 45	€ 7,20	1	088880357
-------	---------	--------	---	-----------

VP-LD

termoformati portaminuterie in materiale plastico per cassetteria C38



VP-LD	H mm 45	€ 7,20	1	088880358
-------	---------	--------	---	-----------

GA/C38-C

guida angolare per C38



GA/C38-C	€ 8,50	5	088880370
----------	--------	---	-----------

GA/C38-SX

guida angolare per C38



GA/C38-SX	€ 6,20	5	088880372
-----------	--------	---	-----------

GA/C38-DX

guida angolare per C38



GA/C38-DX	€ 4,10	5	088880371
-----------	--------	---	-----------

SL/C38

separatore longitudinale per C38



SL/C38	€ 3,10	5	088880381
--------	--------	---	-----------

ST/C38-C

separatore trasversale per C38



ST/C38-C	€ 7,30	5	088880391
----------	--------	---	-----------

ST/C38-SX

separatore trasversale per C38



ST/C38-SX	€ 4,00	5	088880393
-----------	--------	---	-----------

ST/C38-DX

separatore trasversale per C38



ST/C38-DX	€ 2,50	5	088880392
-----------	--------	---	-----------

GA/C41

guida angolare per C41



GA/C41	€ 3,70	5	088880340
--------	--------	---	-----------

SL/C41

separatore longitudinale per C41



SL/C41	€ 2,20	5	088880341
--------	--------	---	-----------

ST/C41

separatore trasversale per C41

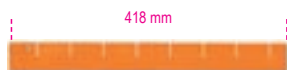

ST/C41	€ 3,20	5	088880346
--------	--------	---	-----------

Separatori per cassettiere e per carrelli

	H mm	LxP mm
C1	50	588x367
C2	70	588x367

Separatori per cassettiere:
C22S, C23S, C23SC

	H mm	LxP mm
C3	50	588x257
C4	70	588x257

GA

guida angolare

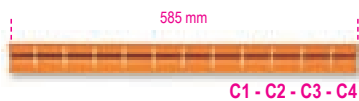

GA	€ 4,10	10	088880300
----	--------	----	-----------

SL1 - SL2

separatori longitudinali

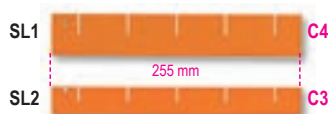

SL1	€ 1,80	10	088880301
SL2	€ 1,70	10	088880302

SL3 - SL4

separatori longitudinali



SL3	€ 2,70	10	088880303
SL4	€ 2,40	10	088880304

ST1 - ST2

separatori trasversali



ST1	€ 3,50	10	088880311
ST2	€ 3,10	10	088880312

GL1 - GL2

combinazioni di separatori paralleli



GL1	€ 17,50	1	088880321
GL2	€ 16,50	1	088880322

GL3 - GL4

combinazioni di separatori paralleli



GL3	€ 21,50	1	088880323
GL4	€ 20,50	1	088880324

TL1 - TL2

combinazioni di separatori incrociati



TL1	€ 16,50	1	088880331
TL2	€ 15,00	1	088880332

TL3 - TL4

combinazioni di separatori incrociati



TL3	€ 23,50	1	088880333
TL4	€ 21,50	1	088880334

SB

guide portabussole



SB	L mm	€		
SB1	210	2,60	10	088880201
SB2	280	2,90	10	088880202
SB3	360	3,10	10	088880203

MB

molle per guide SB



MB0	1/4	€ 0,70	50	088880210
MB1	3/8	€ 0,70	50	088880211
MB2	1/2	€ 0,70	50	088880212

TV - TOV

pannello in lamiera forata



con sostegno TV 46x75 cm	€ 90,00	2	088880001
senza sostegno TOV 46x75 cm	€ 75,00	2	088880002

KIT/GPS

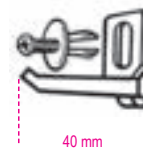

KIT/GPS	€ 0,80	50	088880119
---------	--------	----	-----------

VE1



VE1	€ 0,45	20	088880120
-----	--------	----	-----------

GM



Ø mm	€		
6,5	2,40	5	088880250
9,5	2,50	5	088880251
13	2,60	5	088880252
16	2,70	5	088880253
19	2,80	5	088880254
25	2,90	5	088880255

S55/8

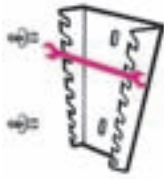

S55/8

55-55MP: 6x7-8x9-10x11
12x13-14x15-16x17
18x19-20x22 mm

€ 13,00  1 088880400

S55/12

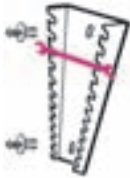

S55/12

55-55MP: 6x7-8x9-10x11
12x13-14x15-16x17
18x19-20x22-21x23
24x26-25x28-30x32 mm

€ 14,50  1 088880401

TSPP

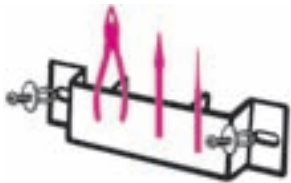

TSPP

€ 4,00  1 088880402

S952

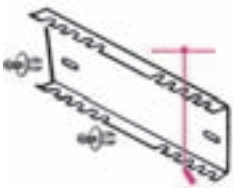

S952

952: 6-7-8-10-11
12-13-14-17-19 mm

€ 13,50  1 088880403

S1719BM



S1719BM

1719BMA: Q-T-P-M-R
1719BMD: Q-T-P-M-R

€ 9,50  1 088880404

SGN



SGN

1290N-1292N-1299N/PZ
1260N-1262N-1269N/PZ
1201N-1202N

€ 4,80  1 088880405

CB/2

solo per C54

12"

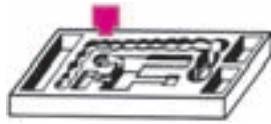

CB/2

920A/920B
10+24+26-27
28-30-32 mm

€ 13,50  1 088880411

S42/18

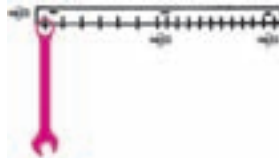

S42/18

42-42MP: 6+22+24 mm
42-42MP: 6+14+16-17
18-19-21-22-24-27-30 mm

€ 16,50  1 088880408

S951/6

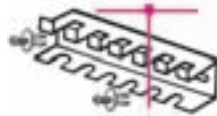

S951/6

951: 2,5-3-4-5-6-8 mm

€ 10,50  1 088880409

SP G9 - SP G11

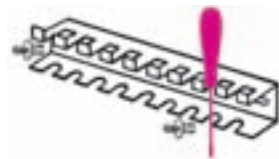

SP G9

n.6 Ø = 7 mm
n.2 Ø = 10 mm
n.1 Ø = 12 mm

€ 12,00  1 088880909

SP G11

n.8 Ø = 7 mm
n.2 Ø = 10 mm
n.1 Ø = 12 mm

€ 12,00 1 088880910

96T/SPV

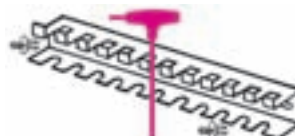

96T/SPV

€ 11,50  1 000960958

 **Beta**



Gamma blister *per la tua vendita a libero servizio!*



Efficienza espositiva

Migliore visibilità

Codice a barre

SUPPORTO BLISTER:

- **PVC Antistrappo**
- **3 formati**
- **Sistema di fissaggio di nuova generazione con fascetta elastica**

42K



mm	€		
6x6	6,30	5	000429006
7x7	6,40	5	000429007
8x8	6,55	5	000429008
9x9	6,75	5	000429009
10x10	7,50	5	000429010
11x11	7,80	5	000429011
12x12	8,05	5	000429012
13x13	8,25	5	000429013
14x14	8,75	5	000429014
15x15	9,65	5	000429015
16x16	10,30	5	000429016
17x17	10,80	5	000429017
18x18	11,90	5	000429018
19x19	12,10	5	000429019
20x20	13,10	3	000429020
21x21	13,80	3	000429021
22x22	14,30	3	000429022
23x23	15,60	3	000429023
24x24	16,70	3	000429024
25x25	17,60	2	000429025
26x26	18,30	2	000429026
27x27	19,30	2	000429027
28x28	20,80	2	000429028
29x29	22,10	2	000429029
30x30	23,20	2	000429030
32x32	26,00	2	000429032

55K



mm	€		
6x7	4,00	5	000559012
8x9	4,10	5	000559021
10x11	4,35	5	000559030
12x13	4,90	5	000559042
14x15	6,10	5	000559054
16x17	6,95	5	000559060
18x19	8,35	2	000559066
20x22	9,50	2	000559075
21x23	10,00	2	000559078
24x26	11,60	2	000559087
25x28	13,10	2	000559096
27x29	15,20	2	000559099
30x32	16,70	2	000559108

90K



mm	€		
6x7	7,80	5	000909006
8x9	8,35	5	000909012
10x11	8,75	5	000909018
12x13	9,65	5	000909027
14x15	10,40	5	000909033
16x17	12,10	5	000909039
18x19	14,10	5	000909045
20x22	16,00	3	000909051
21x23	17,50	2	000909057
24x26	19,90	2	000909063
25x28	22,40	2	000909070
30x32	28,00	2	000909080

93K



mm	€		
21x22	29,00	3	000939021

94K



mm	€		
8x10	13,80	2	000949008
11x13	15,50	2	000949011
17x19	20,10	2	000949017
19x22	20,80	2	000949019

96/SC9



mm	€		
96/SC9	15,30	1	000960374

96/ST6K



mm	€		
96/ST6K	11,60	3	000969370

96N/ST6K



mm	€		
96N/ST6K	8,35	3	000969640

96BPA/SC9



mm	€		
96BPA/SC9	36,00	1	000961974

96BPC/SC9



mm	€		
96BPC/SC9	33,50	1	000960354

96LBP/SC9



mm	€		
96LBP/SC9	38,00	1	000961354

96/BGS7



mm	€		
96/BGS7	22,00	1	000960367



96/BG7



96/BG7 € 23,50 1 000960368
2,5-3-4-5-6-8-10 mm

96TK



mm	€		
2	9,30	5	000969934
2,5	9,30	5	000969935
3	9,30	5	000969936
4	9,45	5	000969938
5	9,75	5	000969940
6	10,50	5	000969941

97BTX/SC8



97BTX/SC8 € 60,00 1 000970164
T9-T10-T15-T20-T25-T27-T30-T40

111K



L mm	€		
150	19,80	5	001119015
200	23,90	5	001119020
250	29,00	5	001119025
300	38,50	3	001119030

123/K4



123/K4 € 22,30 1 001230504

142K



L mm	€		
8	14,00	3	001429008
10	15,40	3	001429010
13	17,80	3	001429013
17	21,20	2	001429017
19	23,50	2	001429019

192/S2



192/S2 € 48,50 1 001920070
8x10/12x13
16x17/18x19 mm

195K



mm	€		
8x10	15,20	2	001959010
12x13	17,80	2	001959013
14x15	18,30	2	001959015
16x18	21,30	2	001959018
17x19	21,80	2	001959019

850MQ



L mm	€		
233	15,00	1	008500910

855P



L1 mm	€		
240	49,00	1	008550010

860/C27



860/C27 € 64,00 1 008600880

860MIX/A10



860MIX/A10 € 28,50 1 008600900

860TX/A10



860TX/A10 € 31,00 1 008600970

860MIX/A31



860MIX/A31 € 63,00 1 008600902

Beta



862F/A7



862F/A7 € 36,00 1 008620950

900K



mm	€		
4	3,35	10	009009040
4,5	3,35	10	009009045
5	3,35	10	009009050
5,5	3,35	10	009009055
6	3,35	10	009009060
7	3,35	10	009009070
8	3,35	10	009009080
9	3,35	10	009009090
10	3,35	10	009009100
11	3,35	10	009009110
12	3,35	10	009009120
13	3,35	10	009009130
14	3,35	10	009009140

900/20LK



L mm 100 € 7,60 5 009009819

900/25K



L mm 41 € 14,30 5 009009830

900BG/30K



L mm 128 € 6,40 5 009009834

900/55K



L mm 125 € 37,00 5 009009870

920AK



mm	€		
10	5,55	10	009209010
11	5,55	10	009209011
12	5,55	10	009209012
13	6,10	10	009209013
14	6,10	10	009209014
15	6,10	10	009209015
16	6,65	10	009209016
17	6,65	10	009209017
18	6,65	10	009209018
19	6,65	10	009209019
20	7,70	5	009209020
21	7,70	5	009209021
22	7,70	5	009209022
23	8,45	5	009209023
24	8,45	5	009209024
25	8,45	5	009209025
26	8,75	5	009209026
27	8,75	5	009209027
28	8,75	5	009209028
29	9,50	5	009209029
30	9,50	5	009209030
32	9,65	5	009209032

920/21K



L mm 125 € 12,10 5 009209822

920/25K



L mm 75 € 21,10 5 009209830

920/55K



L mm 275 € 49,00 3 009209882

935K



mm	€		
6x7	6,40	5	009359105
8x9	6,75	5	009359111
10x11	7,05	5	009359115
12x13	7,70	5	009359117
14x15	9,10	5	009359126
16x17	9,75	5	009359128
18x19	11,00	5	009359131
20x22	14,10	3	009359138

937K



mm	€		
6x6	6,10	5	009379006
7x7	6,40	5	009379007
8x8	6,75	5	009379008
9x9	7,30	5	009379009
10x10	7,40	5	009379010
11x11	7,80	5	009379011
12x12	8,75	5	009379012
13x13	9,00	5	009379013
14x14	9,65	5	009379014
15x15	10,80	5	009379015
16x16	11,80	5	009379016
17x17	12,10	5	009379017
18x18	12,30	5	009379018
19x19	13,10	5	009379019
20x20	14,20	5	009379020
21x21	15,70	3	009379021
22x22	16,90	3	009379022

951K



mm	€		
2,5	14,30	5	009519525
3	14,30	5	009519530
4	14,80	5	009519540
5	16,20	5	009519550
6	18,30	5	009519560
8	19,20	5	009519580

1032K



L mm 180 € 19,20 5 010329017

1034K

L	€		
mm			
170	21,30	5	010349017

1036K

L	€		
mm			
175	20,40	5	010369017

1038K

L	€		
mm			
175	22,40	5	010389017

1044K

L	€		
mm			
250	25,00	5	010449250

1044FK

L	€		
mm			
250	18,30	5	010449015

1046K

L	€		
mm			
240	28,00	5	010469240

1048K

L	€		
mm			
250	27,00	5	010489250

1048VK

L	€		
mm			
250	22,90	5	010489025

1052K

L	€		
mm			
190	22,90	3	010529019
240	23,90	3	010529024

1082BMK

L	€		
mm			
140	23,40	3	010829034
160	26,00	3	010829036

1084BMK

L	€		
mm			
160	27,50	3	010849036

1096K

L	€		
mm			
200	18,30	5	010969020

1098K

L	€		
mm			
190	15,70	5	010989190
220	16,70	5	010989220

1098PLK

L	€		
mm			
220	18,30	5	010989320

1112K

L	€		
mm			
200	18,70	2	011129020

1122K

L	€		
mm			
250	25,00	2	011229020

1123K

L	€		
mm			
250	25,00	2	011239020

1124K

L	€		
mm			
250	25,00	2	011249020

1128BCX

L mm	€		
155	21,00	5	011280080

1128BMX

L mm	€		
145	12,80	5	011280050

1128BSX

L mm	€		
145	21,50	5	011280060

1128BTX

L mm	€		
155	16,50	5	011280070

1130BMX

L mm	€		
200	20,50	1	011300000

1142BMK

L mm	€		
160	27,00	3	011429036

1149F

L mm	€		
175	12,00	1	011490010

1150BMK

L mm	€		
160	20,80	3	011509036
180	22,90	3	011509038
200	25,50	3	011509040
220	27,00	2	011509042

1162BMK

L mm	€		
160	22,90	3	011629036

1164BMK

L mm	€		
160	25,00	3	011649036

1166BMK

L mm	€		
160	22,90	3	011669036

1168BMK

L mm	€		
160	25,00	3	011689036

1201K

SxAxL mm	€		
0,4x2,5x50	2,93	5	012019003
0,5x3x75	3,15	5	012019009
0,5x3x100	3,40	5	012019012
0,6x3,5x100	3,55	5	012019021
0,8x4x100	3,60	5	012019030
0,8x4x125	3,80	5	012019033
1,0x5,5x100	4,35	5	012019039
1,0x5,5x150	4,70	5	012019042
1,2x6,5x150	5,35	5	012019051
1,2x8x150	6,85	3	012019057
1,6x10x200	8,45	3	012019066

1201NK

SxAxL mm	€		
0,8x4x30	4,10	3	012019103
1,2x6,5x30	4,35	3	012019106

1202K

PHxDxL mm	€		
0x3x60	3,05	5	012029003
1x4,5x80	4,05	5	012029009
1x4,5x120	4,30	5	012029012
2x6x100	5,30	5	012029018
2x6x150	5,70	5	012029021
3x8x150	7,15	3	012029024

1202NK

PHxDxL mm	€		
1x4,5x30	4,10	3	012029103
2x6x30	4,35	3	012029106

1204K

SxDxL mm	€		
0,4x2,5x60	2,93	5	012049003
0,5x3x100	3,15	5	012049009
0,8x4x100	3,60	5	012049012
1x5x125	4,35	5	012049018

1207TXK



	€	U	PC
T6	5,40	5	012079006
T7	5,45	5	012079007
T8	5,55	5	012079008
T9	5,80	5	012079009
T10	6,05	5	012079010
T15	6,15	5	012079015
T20	6,25	5	012079020
T25	6,55	5	012079025
T27	6,65	5	012079027
T30	7,05	5	012079030

1208RTXK



	€	U	PC
T9	5,90	5	012089009
T10	6,20	5	012089010
T15	6,60	5	012089015
T20	6,70	5	012089020
T25	6,80	5	012089025
T30	7,60	5	012089030

1209PZK



PZ	€	U	PC
0	3,65	5	012099000
1	4,70	5	012099003
2	6,15	5	012099006
3	9,40	3	012099009

1253



SxAxL mm	€	U	PC
0,5x3,5x100	5,50	5	012530001

1254



SxAxL mm	€	U	PC
0,5x3x44	6,50	5	012540001

1260K



SxAxL mm	€	U	PC
0,4x2,5x50	4,25	5	012609003
0,4x2,5x75	4,35	5	012609006
0,5x3x75	4,45	5	012609009
0,5x3x100	4,55	5	012609012
0,6x3,5x75	4,65	5	012609018
0,6x3,5x100	4,75	5	012609021
0,8x4x100	5,10	5	012609030
0,8x4x125	5,30	5	012609033
0,8x4x150	5,35	5	012609036
1x5,5x100	5,70	5	012609039
1x5,5x150	6,55	5	012609042
1,5x6,5x100	7,05	5	012609048
1,2x6,5x150	7,50	5	012609051
1,2x8x150	9,10	3	012609057
1,2x8x200	9,50	3	012609060
1,6x10x200	11,50	3	012609066

1260NK



SxAxL mm	€	U	PC
0,8x4x30	5,50	5	012609103
1,2x6,5x30	5,95	5	012609106

1260EK



SxAxL mm	€	U	PC
1,6x10x200	14,00	2	012609159
2x12x250	16,10	2	012609162

1262K



PHxDxL mm	€	U	PC
0x3x60	4,35	5	012629003
0x3x100	4,65	5	012629006
1x4,5x80	5,70	5	012629009
1x4,5x120	6,15	5	012629012
2x6x100	7,05	5	012629018
2x6x150	7,70	5	012629021
3x8x150	10,20	3	012629024
4x10x200	13,00	3	012629027

1262NK



PHxDxL mm	€	U	PC
1x4,5x30	5,50	5	012629103
2x6x30	5,95	5	012629106

1262EK



PHxDxL mm	€	U	PC
2x6x150	9,70	3	012629153
3x8x175	12,00	3	012629156

1264K



SxDxL mm	€	U	PC
0,5x2,5x60	4,25	5	012649003
0,6x3x75	4,45	5	012649006
0,8x4x100	5,20	5	012649012
1x5x125	5,90	5	012649018

1267TXK



	€	U	PC
T5	6,60	5	012679005
T6	6,80	5	012679006
T7	7,00	5	012679007
T8	7,35	5	012679008
T9	7,70	5	012679009
T10	8,05	5	012679010
T15	8,45	5	012679015
T20	8,90	5	012679020
T25	9,35	5	012679025
T27	9,60	5	012679027
T30	10,10	5	012679030
T40	10,80	2	012679040
T45	12,50	2	012679045

1268RTXK



	€	U	PC
T9	8,25	3	012689009
T10	8,55	3	012689010
T15	9,00	3	012689015
T20	9,45	3	012689020
T25	9,60	3	012689025
T27	10,10	3	012689027
T30	10,50	3	012689030
T40	11,50	2	012689040

1269PZK



PZ	€		
0	5,00	5	012699000
1	6,35	5	012699001
2	7,90	5	012699002

1269N/PZK



PZ	€		
1	5,50	5	012699011
2	5,95	5	012699012

1290K



SxAxL mm	€		
0,4x2,5x50	5,20	5	012909003
0,4x2,5x75	5,30	5	012909006
0,5x3x75	5,35	10	012909009
0,5x3x100	5,55	10	012909012
0,6x3,5x75	6,15	10	012909018
0,6x3,5x100	6,25	10	012909021
0,8x4x100	6,20	10	012909030
0,8x4x125	6,55	10	012909033
0,8x4x150	6,85	10	012909036
1x5,5x100	7,05	10	012909039
1x5,5x150	7,95	10	012909042
1,2x6,5x100	8,65	10	012909048
1,2x6,5x150	9,35	10	012909051
1,2x8x150	11,50	3	012909057
1,2x8x200	12,20	3	012909060
1,6x10x200	14,40	3	012909066

1290NK



SxAxL mm	€		
0,8x4x30	6,75	5	012909103
1,2x6,5x30	7,50	5	012909106

1292K



PHxDxL mm	€		
0x3x60	5,05	10	012929003
0x3x100	5,55	5	012929006
1x4,5x80	6,85	10	012929009
1x4,5x120	7,50	10	012929012
2x6x100	9,10	10	012929018
2x6x150	9,70	10	012929021
3x8x150	12,20	3	012929024
4x10x200	17,10	3	012929027

1292NK



PHxDxL mm	€		
1x4,5x30	6,40	5	012929103
2x6x30	7,10	5	012929106

1294K



SxDxL mm	€		
0,5x2,5x60	4,75	5	012949003
0,6x3x75	5,00	5	012949006
0,8x4x100	6,25	5	012949012
1x5x125	7,65	5	012949018

1298RTXK



	€		
T9	11,20	5	012989009
T10	11,50	5	012989010
T15	12,20	5	012989015
T20	12,30	5	012989020
T25	12,40	5	012989025
T27	13,20	5	012989027
T30	13,70	5	012989030
T40	14,10	2	012989040

1299PZK



PZ	€		
0	6,65	5	012999000
1	8,40	5	012999003
2	11,50	5	012999006

1299N/PZK



PZ	€		
1	8,45	5	012999021
2	9,30	5	012999024

1603BK



mm ²	€		
0÷8	43,50	2	016039010

1691BG



L m	S mm	€		
3	19	9,00	5	016910103
5	25	12,00	5	016910105
8	25	15,00	3	016910108
10	25	18,00	2	016910110

1692



L m	S mm	€		
2	16	5,50	5	016920052
3	16	7,00	5	016920053
5	19	10,00	5	016920055
8	25	14,50	5	016920058

1729CG



L mm	€		
310	15,50	2	017290200

1729DM 450



L mm	€		
450	17,50	4	017290450

1741B



Ø mm	2,4	3,2	4	4,8	5
Alluminio	•	•	•	•	•
Acciaio	•	•	•	•	•
Inox	•	•	•		

	€		
1741B	28,00	1	017410000

1741U

200 mm

Ø mm	2,4	3	3,2	4	4,8
Alluminio	•	•	•	•	•
Acciaio	•	•	•	•	•
Inox	•	•	•	•	•

1741U € 32,00 1 017410450

1762K

Ø mm
2-2,5-3 € 21,80 2 017629001
3,5-4-4,5

1771

18 mm

170 mm

1771 € 6,90 10 017710000

1770BM

L mm A mm € 8,50 10 017700050
140 9

1771BM

L mm A mm € 15,30 10 017710050
170 18

1773A

L mm A mm € 13,50 10 017730000
180 25

1777BMT

L mm L1 mm A mm € 18,00 5 017770050
170 80 25

1777T

L mm A mm L1 mm € 18,50 5 017770030
160 19 65

1783

L mm € 14,00 5 017830021
215
240 € 15,50 5 017830024

1834S

L mm € 26,00 1 018340010
150

1834M

L mm € 33,00 1 018340020
140

1834L

L mm € 50,00 1 018340025
210

1834XL

L mm € 61,00 1 018340030
315

1837

L mm € 54,00 1 018370001
450

1847K

L mm € 28,00 1 018470101
180



Beta
SHOP
in shop

Beta SHOP *in Shop*

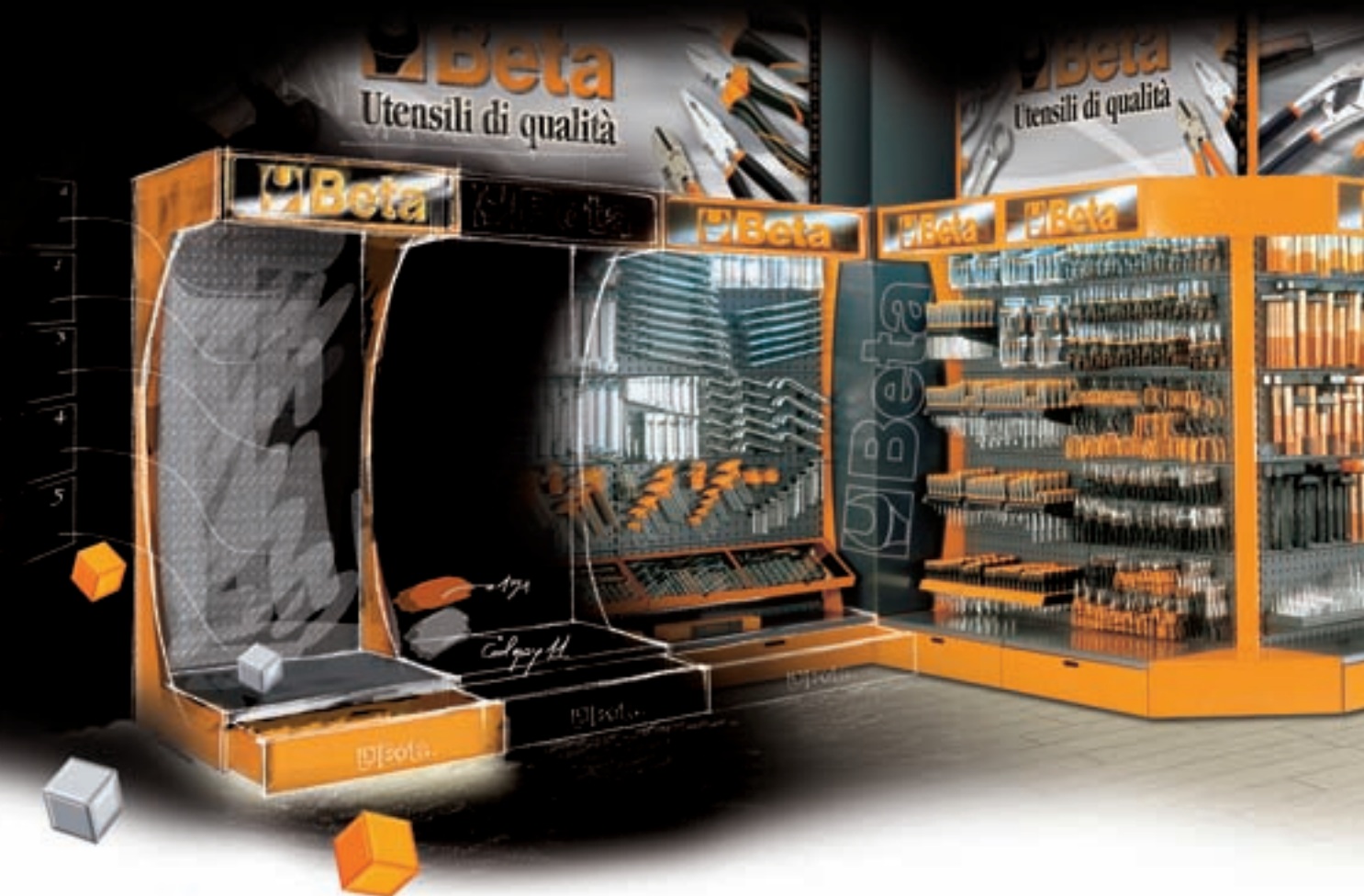

**SOLUZIONI
EPOSITIVE
PER IL PUNTO
VENDITA**

38/DS1

espositore da parete
con 75 utensili a percussione



495x260x332 mm

Espositore con assortimento
38/DS1 € 506,00 1 000380701

	n.	
30	Ø 2 - 3 - 4 - 5 - 6 mm	5
31	Ø 2 - 3 - 4 - 5 - 6 - 8 - 10 mm	5
32	Ø 3 - 4 - 5 mm	5

Espositore vuoto
38/DVS1 € 77,00 1 000380751

38/DS2

espositore da parete
con 65 utensili a percussione

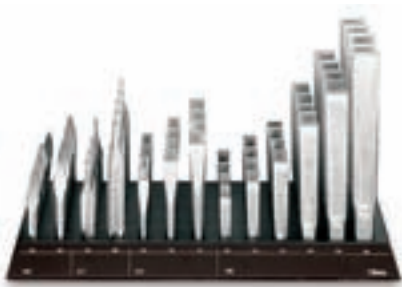

495x260x332 mm

Espositore con assortimento
38/DS2 € 925,00 1 000380702

	n.	
34	125 - 150 - 175 mm	5
35	100 - 125 - 150 - 200 - 250 - 300 mm	5
36	125 - 150 mm	5
37	150 - 200 mm	5

Espositore vuoto
38/DVS2 € 77,00 1 000380752

942BX/DG

espositore da parete
con 43 chiavi a bussola esagonale
con impugnatura tipo corto



330x260x332 mm

Espositore con assortimento
942BX/DG € 516,00 1 009420701

	n.	
942BX	5 - 5,5 mm	3
	6 - 7 mm	6
	8 - 9 - 10 mm	5
	11 mm	2
	12 mm	3
	13 mm	5

Espositore vuoto
942BX/DVG € 65,00 1 009420751

943BX/DG

espositore da parete
con 43 chiavi a bussola esagonale
con impugnatura tipo lungo



330x260x332 mm

Espositore con assortimento
943BX/DG € 559,00 1 009430701

	n.	
943BX	5 - 5,5 mm	3
	6 - 7 mm	6
	8 - 9 - 10 mm	5
	11 mm	2
	12 mm	3
	13 mm	5

Espositore vuoto
943BX/DVG € 65,00 1 009430751

943MQ/BG

espositore da parete
con 30 chiavi a bussola esagonale
con impugnatura



△ 1000 V

330x260x332 mm

Espositore con assortimento
943MQ/BG € 430,00 1 009430281

	n.	
943MQ	5,5 - 6 - 7 - 8 - 10 - 13 mm	5

Espositore vuoto
943BG-MQ/DV € 64,00 1 009430285

1203/E1P

espositore da parete
con 82 giravite



495x260x310 mm

Espositore con assortimento
1203/E1P € 327,00 1 012030301

	n.	
1201	0,4x2,5x50 - 0,5x3x75 - 0,6x3,5x100 0,8x4x100 - 0,8x4x125 mm	7
	1,0x5,5x100 - 1,0x5,5x150 - 1,2x6,5x150 mm	6
	1,2x8x150 mm	5
1202	PH0x3x60 mm	7
	PH1x4,5x80 - PH2x6x100 mm	6
	PH3x8x150 mm	5

Espositore vuoto
1203/EV1P € 77,00 1 012030351

1203/E4P

espositore da parete
con 85 giravite



495x260x310 mm

Espositore con assortimento
1203/E4P € 314,00 1 012030304

n.	
7	1201 0,4x2,5x50 - 0,5x3x75 - 0,8x4x125 mm
6	1,0x5,5x100 - 1,0x5,5x150 - 1,2x6,5x150 mm
7	1204 0,4x2,5x60 - 0,5x3x100 - 0,8x4x100 mm
6	1,0x5x125 mm
7	1209PZ PZ0x3x60 mm
6	PZ1x4,5x80 - PZ2x6x100 mm

Espositore vuoto
1203/EV4P € 77,00 1 012030354

1203/E5P

espositore da parete
con 82 giravite



495x260x310 mm

Espositore con assortimento
1203/E5P € 331,00 1 012030305

n.	
7	1202 PH0x3x60 mm
6	PH1x4,5x80 - PH1x4,5x120
5	PH2x6x100 - PH2x6x150 mm
5	PH3x8x150 mm
7	1204 0,4x2,5x60 - 0,5x3x100 - 0,8x4x100 mm
6	1,0x5x125 mm
7	1209PZ PZ0x3x60 mm
6	PZ1x4,5x80 - PZ2x6x100 mm

Espositore vuoto
1203/EV5P € 77,00 1 012030355

1203/E10P

espositore da parete
con 80 giravite



495x260x310 mm

Espositore con assortimento
1203/E10P € 471,00 1 012030310

n.	
4	1207TX T6
3	T7
7	T8
6	T9 - T10 - T15 - T20 - T25
3	T27 - T30
3	1208RTX T9 - T10
6	T15 - T20 - T25
3	T27 - T30

Espositore vuoto
1203/EV10P € 77,00 1 012030360

1263/E80

espositore da parete e da banco
con 80 giravite



467x325x450 mm

Espositore con assortimento
1263/E80 € 438,00 1 012630500

n.	
4	1260 2,5x50 mm
2	2,5x75 mm
5	3x75 mm
3	3x100 mm
4	3,5x100 mm
5	4x100 mm
3	4x125 mm
5	5,5x125 mm
3	5,5x150 - 6,5x125 mm
5	6,5x150 mm
2	8x200 mm
2	1260N 4x30 - 6,5x30 mm
5	1262 PH0x60 mm
3	PH0x100 mm
5	PH1x80 mm
4	PH1x120 mm
5	PH2x100 mm
4	PH2x150 mm
2	PH3x150 mm
2	1262N PH1x30 - PH2x30 mm

Espositore vuoto
1263/EV80 € 130,00 1 012630501

1263/E85

espositore da parete
con 85 giravite



495x260x377 mm

Espositore con assortimento
1263/E85 € 478,00 1 012630550

n.	
7	1260 2,5x50 mm
6	2,5x75 mm
7	3x75 - 3x100 - 3,5x100 mm
6	4x100 - 4x125 - 5,5x125
4	5,5x150 - 6,5x150 mm
4	8x150 mm
3	1260E 10x200 mm
2	12x250 mm
6	1260N 4x30 - 6,5x30 mm

Espositore vuoto
1263/EV85 € 77,00 1 012630551

1263/E70

espositore da parete
con 70 giravite



495x260x327 mm

Espositore con assortimento
1263/E70 € 474,00 1 012630560

n.	
7	1262 PH0x60 - PH0x100 mm
6	PH1x80 - PH1x120 mm
9	PH2x100 mm
5	PH2x150 - PH3x150 mm
4	PH4x200 mm
5	1262E PH2x150 mm
4	PH3x175 mm
6	1262N PH1x30 - PH2x30 mm

Espositore vuoto
1263/EV70 € 77,00 1 012630561

1263/E50

espositore da parete
con 50 giravite



330x260x269 mm

Espositore
con assortimento
1263/E50 € 249,00 1 012630570

n.		
● 1264	2,5x60 - 3x75 - 3x100 mm	7
	4x100 - 4x125 - 5x125 - 5x150 mm	6
	6,5x150 mm	5

Espositore
vuoto
1263/EV50 € 64,00 1 012630571

1263/E39

espositore da parete
con 39 giravite



330x260x257 mm

Espositore
con assortimento
1263/E39 € 343,00 1 012630595

n.		
⊕ 1268RTX	T9x60 - T10x80 - T15x80 T20x100 - T25x100 mm T27x115 mm	6
	T30x115 mm	3
	T40x130 mm	2

Espositore
vuoto
1263/EV39 € 64,00 1 012630596

1273MQ/E1

espositore da parete
con 40 giravite



⚡ 1000 V ⚡

330x260x332 mm

Espositore
con assortimento
1273MQ/E1 € 360,00 1 012730312

n.		
⊕ 1272MQ	PH0x60 - PH1x80 mm	5
	PH2x100 mm	3
	PH3x150 mm	2
● 1274MQ	3x100 - 4x100 - 5,5x125 - 6,5x150 mm	5
	8x175 mm	3
	10x200 mm	2

Espositore
vuoto
1273BG-MQ/DV € 64,00 1 012730651

1263/E62

espositore da parete
con 62 giravite



495x260x257 mm

Espositore
con assortimento
1263/E62 € 484,00 1 012630590

n.		
⊕ 1267TX	T5	5
	T6	6
	T7	5
	T8	6
	T9	5
	T10 - T15 - T20	6
	T25	5
	T27 - T30	4
	T40 - T45	2

Espositore
vuoto
1263/EV62 € 77,00 1 012630591

1263/E40

espositore da parete
con 40 giravite



330x260x327 mm

Espositore
con assortimento
1263/E40 € 288,00 1 012630580

n.		
⊕ 1269	PZ0x60 mm	7
	PZ1x80 mm	6
	PZ2x100 - PZ3x150 - PZ4x200 mm	5
⊕ 1269N	PZ1x30 - PZ2x30 mm	6

Espositore
vuoto
1263/EV40 € 64,00 1 012630581

1293BX/DA

espositore da parete
con 90 giravite



495x260x332 mm

Espositore
con assortimento
1293BX/DA € 635,00 1 012930701

n.		
● 1290	3x75 - 3,5x100 - 4x100 - 4x125 5,5x100 - 5,5x150 mm 6,5x150 mm	7
	8x150 mm	3
	10x200 mm	2
● 1290N	4x30 - 6,5x30 mm	3
⊕ 1292	PH0x60 - PH1x80 mm	7
	PH2x100 mm	6
	PH3x150 mm	5
⊕ 1292N	PH1x30 - PH2x30 mm	3

Espositore
vuoto
1293BX/DVA € 77,00 1 012930751

1293BX/DD

espositore da parete
con 48 giravite



330x260x332 mm

Espositore
con assortimento
1293BX/DD € 287,00 1 012930704

● 1294	2,5x60 - 3x75 - 3x100 - 4x100 4x150 - 5x125 mm 6,5x150 mm	7 6
--------	---	--------

Espositore
vuoto
1293BX/DVD € 64,00 1 012930754

1293BX/DE

espositore da parete
con 42 giravite



330x260x332 mm

Espositore
con assortimento
1293BX/DE € 457,00 1 012930705

⊕ 1299PZ	PZ0x60 - PZ1x80 mm PZ2x100 mm PZ3x150 - PZ4x200 mm	7 6 5
⊕ 1299N/PZ	PZ1x30 - PZ2x30 mm	6

Espositore
vuoto
1293BX/DVE € 64,00 1 012930755

1293BX/DF

espositore da parete
con 59 giravite



330x260x332 mm

Espositore
con assortimento
1293BX/DF € 629,00 1 012930706

⊙ 1297TX	T6 - T8 - T10 - T15 - T20 - T25 T27 - T30 T40	7 6 5
----------	---	-------------

Espositore
vuoto
1293BX/DVF € 64,00 1 012930756

C68

parete espositiva vuota Beta



1000x560x2200 mm

C68/1	1 m	€ 1.285,00	1 068000001
C68/2	2 m	€ 2.210,00	1 068000002
C68/3	3 m	€ 3.140,00	1 068000003
C68/4	4 m	€ 4.060,00	1 068000004
C68/5	5 m	€ 4.990,00	1 068000005
C68/6	6 m	€ 5.920,00	1 068000006
C68/7	7 m	€ 6.840,00	1 068000007
C68/8	8 m	€ 7.770,00	1 068000008
C68/9	9 m	€ 8.690,00	1 068000009
C68/10	10 m	€ 9.620,00	1 068000010

C68 G

gondola espositiva vuota



1000x1120x1600 mm

C68 G/1	1 m	€ 1.205,00	1 068000051
C68 G/2	2 m	€ 2.195,00	1 068000052
C68 G/3	3 m	€ 3.180,00	1 068000053
C68 G/4	4 m	€ 4.170,00	1 068000054

C88 R/1

parete espositiva vuota Robur



1000x560x2200 mm

C88 R/1 € 1.285,00 1 088000001



6888

ganci per espositori C60 - C61 - C68 - C88

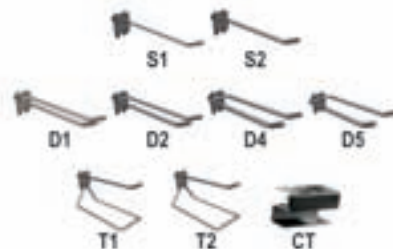

6888 S1	€ 3,10	10 068880011
6888 S2	€ 3,10	10 068880012
6888 D1	€ 5,00	5 068880021
6888 D2	€ 5,00	5 068880022
6888 D4	€ 5,20	5 068880024
6888 D5	€ 5,20	5 068880025
6888 T1	€ 7,20	5 068880031
6888 T2	€ 7,20	5 068880032
6888 CT	€ 9,50	1 068880044

6800 VE

vetrina per parete espositiva C68 e C68 R/1



		€		
6800 VE/1	1 m	725,00	1	068000401
6800 VE/2	2 m	1.100,00	1	068000402
6800 VE/3	3 m	1.475,00	1	068000403
6800 VE/4	4 m	1.850,00	1	068000404
6800 VE/5	5 m	2.225,00	1	068000405

ACCESSORI C68

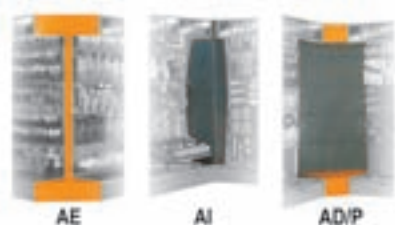

		€		
6800 AE		150,00	1	068000145
6800 AI		320,00	1	068000140
6800 AD/P		417,00	1	068000143



		€		
6800 CB/100		150,00	1	068000104
6800 FB/100		60,00	1	068000109
6800 FO/100		45,00	1	068000108
6800 PL		140,00	1	068000137
6800 RP/100		50,00	1	068000150
6800 GR/37		20,00	1	068000159

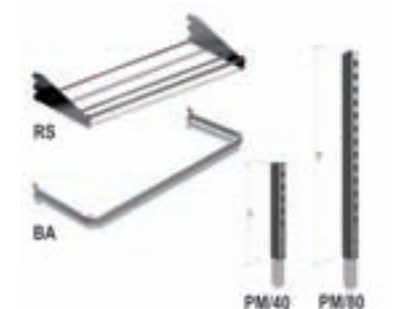

		€		
6800 BA		75,00	1	068000130
6800 RS		62,00	1	068000135
6800 PM/40		55,00	1	068000171
6800 PM/80		65,00	1	068000172

6600 M/10

assortimento 178 utensili, con ganci senza pannello

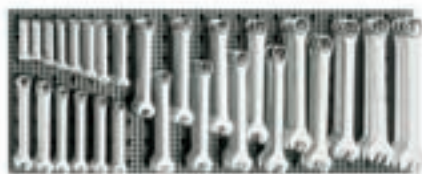

		€		
6600 M/10		1.820,00	1	066000010

6600 M/21

assortimento 127 utensili, con ganci senza pannello



		€		
6600 M/21		1.119,00	1	066000021

6600 M/27

assortimento 25 utensili, con ganci senza pannello



		€		
6600 M/27		748,00	1	066000027

6600 M/30

assortimento 18 utensili, con ganci senza pannello



		€		
6600 M/30		920,00	1	066000030

6600 M/38

assortimento di 107 utensili con ganci senza pannello



		€		
6600 M/38		1.300,00	1	066000038

6600 M/39

assortimento 77 utensili, con ganci senza pannello



		€		
6600 M/39		1.450,00	1	066000039

6600 M/40

assortimento 100 utensili, con ganci senza pannello



		€		
6600 M/40		1.965,00	1	066000040

6600 M/47

assortimento 65 utensili, con ganci senza pannello



		€		
6600 M/47		1.087,00	1	066000047

6600 M/51

assortimento di 257 utensili
con ganci senza pannello



6600 M/51 € 2.035,00 1 066000051

6600 M/52

assortimento di 176 utensili
con ganci senza pannello



6600 M/52 € 1.335,00 1 066000052

6600 M/58

assortimento di 150 utensili
con ganci senza pannello



6600 M/58 € 1.485,00 1 066000058



6600 M/60

assortimento 118 utensili,
con ganci senza pannello

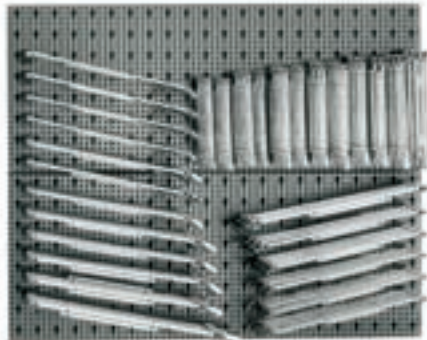

6600 M/60 € 2.690,00 1 066000060

6600 M/63

assortimento di 110 utensili
con ganci senza pannello

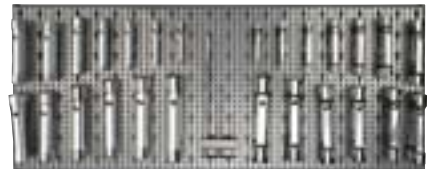

6600 M/63 € 1.620,00 1 066000063

6600 M/73

assortimento di 68 utensili
con ganci senza pannello



6600 M/73 € 1.138,00 1 066000073

6600 M/74

assortimento di 68 utensili
con ganci senza pannello



6600 M/74 € 1.138,00 1 066000074

6600 M/75

assortimento di 82 utensili
con ganci senza pannello



6600 M/75 € 997,00 1 066000075

6600 M/112

assortimento 329 utensili,
con ganci senza pannello

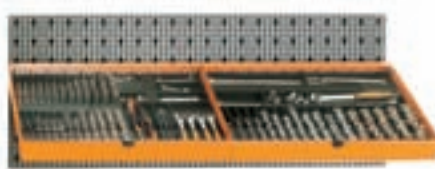

6600 M/112 € 2.015,00 1 066000112

6600 M/116

assortimento 306 utensili,
con ganci senza pannello



6600 M/116 € 1.875,00 1 066000116



6600 M/120

assortimento 163 utensili,
con ganci senza pannello



6600 M/120 € 1.400,00 1 066000120

6600 M/125

assortimento 133 utensili,
con ganci senza pannello



6600 M/125 € 1.200,00 1 066000125

6600 M/131

assortimento 92 utensili,
con ganci senza pannello



6600 M/131 € 2.155,00 1 066000131

6600 M/152

assortimento 12 utensili,
con ganci senza pannello



6600 M/152 € 2.890,00 1 066000152

6600 M/163

assortimento 30 utensili,
con ganci senza pannello



6600 M/163 € 3.930,00 1 066000163

6600 M/171

assortimento 13 utensili,
con ganci senza pannello



6600 M/171 € 2.950,00 1 066000171

6600 M/216

assortimento di 80 utensili
con ganci senza pannello



6600 M/216 € 2.035,00 1 066000216

6600 M/221

assortimento di 83 utensili
con ganci senza pannello



6600 M/221 € 1.650,00 1 066000221

6600 M/230

assortimento 78 utensili,
con ganci senza pannello



6600 M/230 € 1.730,00 1 066000230

6600 M/234

assortimento di 31 utensili
con ganci senza pannello



6600 M/234 € 982,00 1 066000234

6600 M/241

assortimento di 43 utensili,
con ganci senza pannello

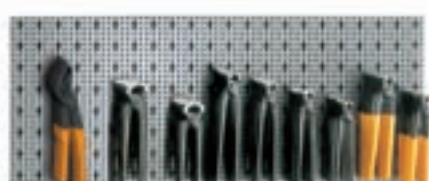

6600 M/241 € 810,00 1 066000241

6600 M/244

assortimento di 91 utensili
con ganci senza pannello



6600 M/244 € 1.975,00 1 066000244

6600 M/247

assortimento di 86 utensili
con ganci senza pannello



6600 M/247 € 2.115,00 1 066000247

6600 M/315

assortimento 149 utensili,
con ganci senza pannello

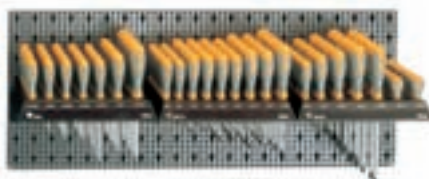

6600 M/315 € 1.370,00 1 066000315

6600 M/330

assortimento 110 utensili,
con ganci senza pannello

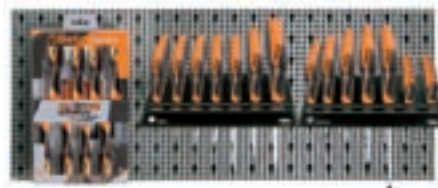

6600 M/330 € 642,00 1 066000330

6600 M/251

assortimento 26 utensili,
con ganci senza pannello



6600 M/251 € 746,00 1 066000251

6600 M/320

assortimento 98 utensili,
con ganci senza pannello

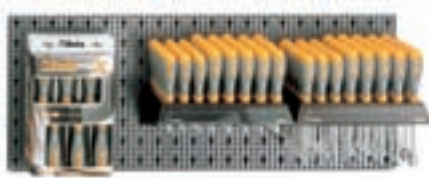

6600 M/320 € 1.230,00 1 066000320

6600 M/370

assortimento 162 utensili,
con ganci senza pannello

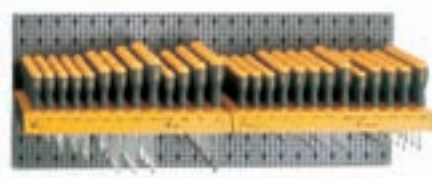

6600 M/370 € 797,00 1 066000370

6600 M/311

assortimento 114 utensili,
con ganci senza pannello



6600 M/311 € 817,00 1 066000311

6600 M/326

assortimento 155 utensili,
con ganci senza pannello



6600 M/326 € 953,00 1 066000326

6600 M/377

assortimento di 73 utensili
con ganci senza pannello



6600 M/377 € 535,00 1 066000377

6600 M/327

assortimento 101 utensili,
con ganci senza pannello

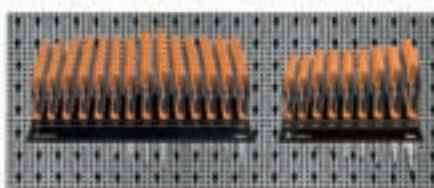

6600 M/327 € 827,00 1 066000327

6600 M/417

assortimento 43 utensili,
con ganci senza pannello



6600 M/417 € 738,00 1 066000417

 **Beta**



6600 M/418

assortimento 35 utensili,
con ganci senza pannello



6600 M/418 € 798,00 1 066000418

6600 M/427

assortimento 24 utensili,
con ganci senza pannello



6600 M/427 € 774,00 1 066000427

6600 M/430

assortimento 29 utensili,
con ganci senza pannello



6600 M/430 € 737,00 1 066000430

6600 M/440

assortimento 140 utensili,
con ganci senza pannello

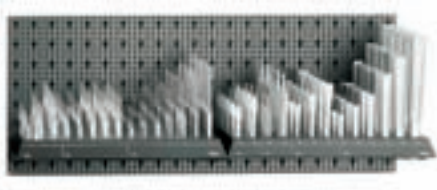

6600 M/440 € 1.430,00 1 066000440

6600 M/456

assortimento di 41 utensili,
con ganci senza pannello



6600 M/456 € 1.187,00 1 066000456

6600 M/464

assortimento 36 utensili,
con ganci senza pannello



6600 M/464 € 1.325,00 1 066000464

6600 M/472

assortimento di 33 utensili,
con ganci senza pannello



6600 M/472 € 1.155,00 1 066000472

6600 M/480

assortimento 18 utensili,
con ganci senza pannello



6600 M/480 € 872,00 1 066000480

6600 M/485

assortimento 12 utensili,
con ganci senza pannello

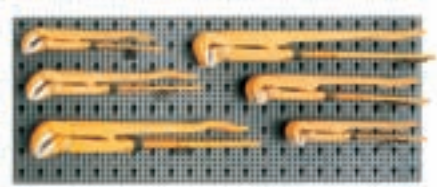

6600 M/485 € 616,00 1 066000485

6600 M/510

assortimento 16 utensili,
con ganci senza pannello



6600 M/510 € 837,00 1 066000510

6600 M/519

assortimento di 22 utensili,
con ganci senza pannello



6600 M/519 € 572,00 1 066000519

 **Beta**



6600 M/525

assortimento 73 utensili,
con ganci senza pannello



6600 M/525 € 1.740,00 1 066000525

6600 M/532

assortimento di 24 utensili
con ganci senza pannello



6600 M/532 € 664,00 1 066000532

6600 M/542

assortimento di 53 utensili,
con ganci senza pannello



6600 M/542 € 669,00 1 066000542

6600 M/550

assortimento 442 utensili,
con ganci senza pannello



6600 M/550 € 2.810,00 1 066000550

6600 M/561

assortimento 60 utensili,
con ganci senza pannello



6600 M/561 € 871,00 1 066000561

6600 M/583

assortimento di 22 utensili
con ganci senza pannello



6600 M/583 € 693,00 1 066000583

6600 M/617

assortimento di 67 utensili,
con ganci senza pannello



6600 M/617 € 2.070,00 1 066000617

6600 M/635

assortimento di 87 utensili,
con ganci senza pannello



6600 M/635 € 1.420,00 1 066000635

6600 M/650

assortimento 28 utensili,
con ganci senza pannello



6600 M/650 € 1.870,00 1 066000650

6600 M/657

assortimento 17 utensili,
con ganci senza pannello



6600 M/657 € 1.440,00 1 066000657

6600 M/658

assortimento di 14 utensili
con ganci senza pannello



6600 M/658 € 1.600,00 1 066000658

6600 M/714

assortimento 63 utensili,
con ganci senza pannello



6600 M/714 € 2.140,00 1 066000714

6600 M/724

assortimento 12 utensili,
con ganci senza pannello



6600 M/724 € 2.045,00 1 066000724

6600 M/818

assortimento 102 utensili,
con ganci senza pannello



6600 M/818 € 2.325,00 1 066000818

6600 M/824

assortimento di 37 utensili,
con ganci senza pannello



6600 M/824 € 1.139,00 1 066000824

6600 M/835

assortimento di 34 utensili,
con ganci senza pannello



6600 M/835 € 1.670,00 1 066000835



8600 R/10

assortimento 672 accessori per funi,
con ganci senza pannello

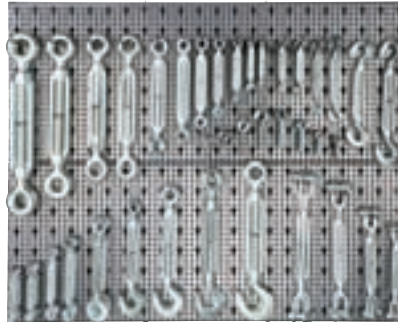

8600 R/10 € 1.900,00 1 086000010

8600 R/111

assortimento 1887 accessori per funi,
con ganci senza pannello

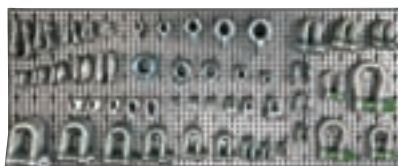

8600 R/111 € 2.390,00 1 086000111

8600 R/222

assortimento 57 accessori per funi,
con ganci senza pannello



8600 R/222 € 1.340,00 1 086000222

8600 R/411

assortimento di 551 accessori INOX per funi
con ganci senza pannello



8600 R/411 € 2.750,00 1 086000411

8600 E/R

assortimento di 3167 accessori per funi,
con ganci senza espositore



8600 E/R € 8.380,00 1 086000914



6600 E/A10

assortimento di 802 utensili
con ganci senza espositore



6600 E/A10 € 7.820,00 1 066000914

6600 E/A30

assortimento di 753 utensili
con ganci senza espositore



6600 E/A30 € 6.890,00 1 066000919

6600 E/B20

assortimento di 601 utensili
con ganci senza espositore



6600 E/B20 € 3.750,00 1 066000923

6600 E/A20

assortimento di 707 utensili
con ganci senza espositore



6600 E/A20 € 7.800,00 1 066000917

6600 E/B10

assortimento di 596 utensili
con ganci senza espositore



6600 E/B10 € 4.750,00 1 066000916

6600 E/C10

assortimento di 313 utensili
con ganci senza espositore



6600 E/C10 € 7.590,00 1 066000929

6600 E/D10

assortimento di 271 utensili
con ganci senza espositore



6600 E/D10 € 4.480,00 1 066000966

6600 E/K10

assortimento di 610 utensili
con ganci senza espositore



6600 E/K10 € 5.990,00 1 066000987

6600 E/K20

assortimento di 499 utensili
con ganci senza espositore



6600 E/K20 € 5.510,00 1 066000989

6600 E/E10

assortimento di 140 utensili
con ganci senza espositore



6600 E/E10 € 5.160,00 1 066000975



6600 E/P10

assortimento di 69 utensili
con ganci senza espositore



6600 E/P10 € 8.250,00 1 066000967

CALZATURE DI SICUREZZA

La linea di calzature di sicurezza ha conquistato nel corso degli anni la fiducia e la preferenza dei professionisti più esigenti. Il successo del prodotto ha generato la costante evoluzione e l'ampliamento della gamma di offerta.

NORMATIVE DI SICUREZZA

COME OTTIMIZZARE LA SCELTA DELLE CALZATURE DI SICUREZZA

Assicuratevi che la calzatura corrisponda alla categoria di protezione richiesta, in funzione del tipo e luogo di lavoro.

Di seguito riportiamo le norme Europee di riferimento con le eventuali caratteristiche supplementari.

NORME EUROPEE EN

EN ISO 20344: Metodologia di prova e requisiti generali.

EN ISO 20345: Calzature di sicurezza con puntale resistente a 200 Joule.

EN ISO 20346: Calzature di protezione con puntale resistente a 100 Joule.

EN ISO 20347: Calzature da lavoro, non prevista la presenza di puntale.

EN ISO 20345 Le calzature che rientrano in questa norma sono contraddistinte dalla lettera "S" (safety = sicurezza)

Per individuare la categoria di protezione la lettera "S" è seguita da lettere e/o numeri.

SB Requisiti minimi:

Puntale con resistenza di 200 Joule.

Tomaia in pelle crosta o similare.

Altezza minima della tomaia.

S1 Caratteristiche SB integrate da:

Antistaticità (A).

Assorbimento d'energia nella zona del tallone (E).

Calzatura chiusa posteriormente. (Anche calzatura bassa)

Antiscivolo UNI EN ISO 20345. Metodo secondo la norma EN 13287

S2 Caratteristiche S1 integrate da:

Impermeabilità della tomaia, resistenza all'acqua per minimo di 1h (WRU).

S3 Caratteristiche S2 integrate da:

Lamina od inserto antiperforazione (P).

Suola scolpita o tassellata.

S4 Caratteristiche S1 integrate da:

Resistenza agli idrocarburi (ORO).

S5 Caratteristiche S4 integrate da:

Lamina od inserto antiperforazione (P).

Suola scolpita o tassellata.

EN ISO 20346 Sono calzature sostanzialmente uguali a quelle di

sicurezza, ma avendo il puntale con una resistenza di 100 Joule

hanno una marcatura con la lettera "P" (Protective = protezione) e

quindi sono riconosciute come Calzature di protezione

Vengono utilizzate ove è sufficiente una protezione di soli 100 Joule.

EN ISO 20347 Sono calzature senza il puntale di protezione, la

marcatura avviene con la lettera "O" (Occupational = professionale),

quindi sono considerate calzature professionali.

Per facilitare l'identificazione delle caratteristiche tecniche delle calzature che più si addicono alle vostre esigenze vi consigliamo di prendere visione delle icone di seguito rappresentate.



Lamina o inserto antiperforazione.



Puntale in acciaio, in alluminio o in plastica.



Scarpa antistatica.



Assorbimento di energia nella zona del tallone.



Suola resistente ad olii, idrocarburi e solventi.



Suola antiscivolo.



Resistenza alle flessioni ripetute > 60.000.



Suola resistente al calore per contatto (300 °C/min).



Calzatura con ampia calzata per garantire maggiore comfort



Calzatura amagnetica, totalmente priva di componenti metallici



Calzatura sviluppata per assicurare la costante dissipazione delle cariche elettrostatiche dal corpo al suolo



Calzatura sviluppata per garantire l'isolamento dal freddo (CI)

AVVERTENZE

CONTROLLI PRELIMINARI ED UTILIZZO

Prima dell'uso effettuare un controllo visivo dello stato generale della calzatura verificando cuciture, stato della suola e sistemi di chiusura, controllando inoltre che la calzatura abbia tutte le caratteristiche indicate dall'etichetta, ed in

special modo se la calzatura prevede puntale e lamina antiperforazione.

IMPIEGHI SCONSIGLIATI

Sono tassativamente sconsigliati gli impieghi prolungati e/o ripetuti:

- a contatto con agenti organici, diserbanti, pesticidi ed acidi in forte concentrazione.
- a temperature estreme (oltre -10 °C e + 70 °C).
- di immersione completa in acqua, fango, malte e similari.

SCADENZA

A causa dei numerosi fattori (umidità durante l'immagazzinamento e modificazione della struttura dei materiali nel tempo) non è possibile stabilire con certezza la durata di immagazzinamento della scarpa. In generale, per calzature interamente in poliuretano o con fondo in poliuretano è comunque ipotizzabile una durata massima di tre anni. Per le altre tipologie di calzature è ipotizzabile una durata massima di cinque anni. Tale termine si intende per calzature nuove, imballate e conservate in condizioni controllate, evitando cioè forti escursioni termiche e di umidità relativa

7240B

scarpe in pelle senza lamina antiperforazione

- Puntale in acciaio
- Senza lamina antiperforazione

EN ISO 2011



EN 20345 S1 SRC



EU	UK	€		
35	2,5	32,00	1	072400235
36	3,5	32,00	1	072400236
37	4,5	32,00	1	072400237
38	5	32,00	1	072400238
39	6	32,00	1	072400239
40	6,5	32,00	1	072400240
41	7	32,00	1	072400241
42	8	32,00	1	072400242
43	9	32,00	1	072400243
44	10	32,00	1	072400244
45	10,5	32,00	1	072400245
46	11	32,00	1	072400246
47	12	32,00	1	072400247
48	13	32,00	1	072400248

7241B

scarpe in pelle con lamina antiperforazione

- Puntale in acciaio
- Lamina antiperforazione in acciaio elastico

EN ISO 2011



EN 20345 S1P SRC



EU	UK	€		
35	2,5	33,50	1	072410235
36	3,5	33,50	1	072410236
37	4,5	33,50	1	072410237
38	5	33,50	1	072410238
39	6	33,50	1	072410239
40	6,5	33,50	1	072410240
41	7	33,50	1	072410241
42	8	33,50	1	072410242
43	9	33,50	1	072410243
44	10	33,50	1	072410244
45	10,5	33,50	1	072410245
46	11	33,50	1	072410246
47	12	33,50	1	072410247
48	13	33,50	1	072410248

7246B

scarpe in pelle scamosciata, traforate

- Puntale in acciaio
- Lamina antiperforazione in acciaio elastico

EN ISO 2011



EN 20345 S1P SRC



EU	UK	€		
35	2,5	35,50	1	072460235
36	3,5	35,50	1	072460236
37	4,5	35,50	1	072460237
38	5	35,50	1	072460238
39	6	35,50	1	072460239
40	6,5	35,50	1	072460240
41	7	35,50	1	072460241
42	8	35,50	1	072460242
43	9	35,50	1	072460243
44	10	35,50	1	072460244
45	10,5	35,50	1	072460245
46	11	35,50	1	072460246
47	12	35,50	1	072460247
48	13	35,50	1	072460248

7247B

sandali in pelle traforata

- Puntale in acciaio
- Lamina antiperforazione in acciaio elastico

EN ISO 2011



EN 20345 S1P SRC



EU	UK	€		
35	2,5	35,00	1	072470235
36	3,5	35,00	1	072470236
37	4,5	35,00	1	072470237
38	5	35,00	1	072470238
39	6	35,00	1	072470239
40	6,5	35,00	1	072470240
41	7	35,00	1	072470241
42	8	35,00	1	072470242
43	9	35,00	1	072470243
44	10	35,00	1	072470244
45	10,5	35,00	1	072470245
46	11	35,00	1	072470246
47	12	35,00	1	072470247
48	13	35,00	1	072470248

7242B

scarpe alte in pelle senza lamina antiperforazione

- Puntale in acciaio
- Senza lamina antiperforazione



EU	UK	€		
35	2,5	33,00	1	072420235
36	3,5	33,00	1	072420236
37	4,5	33,00	1	072420237
38	5	33,00	1	072420238
39	6	33,00	1	072420239
40	6,5	33,00	1	072420240
41	7	33,00	1	072420241
42	8	33,00	1	072420242
43	9	33,00	1	072420243
44	10	33,00	1	072420244
45	10,5	33,00	1	072420245
46	11	33,00	1	072420246
47	12	33,00	1	072420247
48	13	33,00	1	072420248



EN 20345 S1 SRC



7243B

scarpe alte in pelle con lamina antiperforazione

- Puntale in acciaio
- Lamina antiperforazione in acciaio elastico



EU	UK	€		
35	2,5	34,50	1	072430235
36	3,5	34,50	1	072430236
37	4,5	34,50	1	072430237
38	5	34,50	1	072430238
39	6	34,50	1	072430239
40	6,5	34,50	1	072430240
41	7	34,50	1	072430241
42	8	34,50	1	072430242
43	9	34,50	1	072430243
44	10	34,50	1	072430244
45	10,5	34,50	1	072430245
46	11	34,50	1	072430246
47	12	34,50	1	072430247
48	13	34,50	1	072430248



EN 20345 S1P SRC



7243C

scarpe alte in pelle pieno fiore con lamina antiperforazione e rapido sfilamento

- Puntale in acciaio
- Lamina antiperforazione in acciaio elastico



EU	UK	€		
35	2,5	36,00	1	072430335
36	3,5	36,00	1	072430336
37	4,5	36,00	1	072430337
38	5	36,00	1	072430338
39	6	36,00	1	072430339
40	6,5	36,00	1	072430340
41	7	36,00	1	072430341
42	8	36,00	1	072430342
43	9	36,00	1	072430343
44	10	36,00	1	072430344
45	10,5	36,00	1	072430345
46	11	36,00	1	072430346
47	12	36,00	1	072430347
48	13	36,00	1	072430348



EN 20345 S3 RS SRC



7245B

scarpe "saldatore" stringate in pelle pieno fiore idrorepellente con rapido sfilamento e protezione frontale con chiusura a strappo

- Puntale in acciaio
- Lamina antiperforazione in acciaio elastico



EU	UK	€		
35	2,5	42,00	1	072450235
36	3,5	42,00	1	072450236
37	4,5	42,00	1	072450237
38	5	42,00	1	072450238
39	6	42,00	1	072450239
40	6,5	42,00	1	072450240
41	7	42,00	1	072450241
42	8	42,00	1	072450242
43	9	42,00	1	072450243
44	10	42,00	1	072450244
45	10,5	42,00	1	072450245
46	11	42,00	1	072450246
47	12	42,00	1	072450247
48	13	42,00	1	072450248



EN 20345 S3 RS SRC



7200BKK

scarpe in pelle pieno fiore idrorepellente

- Puntale in composito
- Lamina antiperforazione in fibra composita

EN ISO 2011



EN 20345 S3 SRC



EU	UK	€		
35	2,5	53,00	1	072000235
36	3,5	53,00	1	072000236
37	4,5	53,00	1	072000237
38	5	53,00	1	072000238
39	6	53,00	1	072000239
40	6,5	53,00	1	072000240
41	7	53,00	1	072000241
42	8	53,00	1	072000242
43	9	53,00	1	072000243
44	10	53,00	1	072000244
45	10,5	53,00	1	072000245
46	11	53,00	1	072000246
47	12	53,00	1	072000247
48	13	53,00	1	072000248

7201BKK

scarpe alte in pelle pieno fiore idrorepellente

- Puntale in composito
- Lamina antiperforazione in fibra composita

EN ISO 2011



EN 20345 S3 SRC



EU	UK	€		
35	2,5	56,00	1	072010435
36	3,5	56,00	1	072010436
37	4,5	56,00	1	072010437
38	5	56,00	1	072010438
39	6	56,00	1	072010439
40	6,5	56,00	1	072010440
41	7	56,00	1	072010441
42	8	56,00	1	072010442
43	9	56,00	1	072010443
44	10	56,00	1	072010444
45	10,5	56,00	1	072010445
46	11	56,00	1	072010446
47	12	56,00	1	072010447
48	13	56,00	1	072010448

7205BKK

scarpe in pelle pieno fiore idrorepellente, ampia calzata

- Puntale in composito
- Lamina antiperforazione in fibra composita

EN ISO 2011



EN 20345 S3 SRC



EU	UK	€		
35	2,5	54,00	1	072050235
36	3,5	54,00	1	072050236
37	4,5	54,00	1	072050237
38	5	54,00	1	072050238
39	6	54,00	1	072050239
40	6,5	54,00	1	072050240
41	7	54,00	1	072050241
42	8	54,00	1	072050242
43	9	54,00	1	072050243
44	10	54,00	1	072050244
45	10,5	54,00	1	072050245
46	11	54,00	1	072050246
47	12	54,00	1	072050247
48	13	54,00	1	072050248

7206BKK

scarpe alte in pelle pieno fiore idrorepellente con rapido sfilamento, ampia calzata

- Puntale in composito
- Lamina antiperforazione in fibra composita

EN ISO 2011



EN 20345 S3 RS SRC



EU	UK	€		
35	2,5	57,50	1	072060235
36	3,5	57,50	1	072060236
37	4,5	57,50	1	072060237
38	5	57,50	1	072060238
39	6	57,50	1	072060239
40	6,5	57,50	1	072060240
41	7	57,50	1	072060241
42	8	57,50	1	072060242
43	9	57,50	1	072060243
44	10	57,50	1	072060244
45	10,5	57,50	1	072060245
46	11	57,50	1	072060246
47	12	57,50	1	072060247
48	13	57,50	1	072060248

7210BKK

scarpe in morbida pelle scamosciata traforata

- Puntale in composito
- Lamina antiperforazione in fibra composita



EU	UK	€		
35	2,5	50,00	1	072100335
36	3,5	50,00	1	072100336
37	4,5	50,00	1	072100337
38	5	50,00	1	072100338
39	6	50,00	1	072100339
40	6,5	50,00	1	072100340
41	7	50,00	1	072100341
42	8	50,00	1	072100342
43	9	50,00	1	072100343
44	10	50,00	1	072100344
45	10,5	50,00	1	072100345
46	11	50,00	1	072100346
47	12	50,00	1	072100347
48	13	50,00	1	072100348



EN 20345 S1P SRC

EN ISO 2011



7211BK

scarpe in morbida pelle scamosciata traforata, senza lamina antiperforazione

- Puntale in composito
- Senza lamina antiperforazione



EU	UK	€		
35	2,5	46,50	1	072110335
36	3,5	46,50	1	072110336
37	4,5	46,50	1	072110337
38	5	46,50	1	072110338
39	6	46,50	1	072110339
40	6,5	46,50	1	072110340
41	7	46,50	1	072110341
42	8	46,50	1	072110342
43	9	46,50	1	072110343
44	10	46,50	1	072110344
45	10,5	46,50	1	072110345
46	11	46,50	1	072110346
47	12	46,50	1	072110347
48	13	46,50	1	072110348



EN 20345 S1 SRC

EN ISO 2011



7216BKK

sandali in morbida pelle scamosciata con chiusura a strappo

- Puntale in composito
- Lamina antiperforazione in fibra composita



EU	UK	€		
35	2,5	53,00	1	072160335
36	3,5	53,00	1	072160336
37	4,5	53,00	1	072160337
38	5	53,00	1	072160338
39	6	53,00	1	072160339
40	6,5	53,00	1	072160340
41	7	53,00	1	072160341
42	8	53,00	1	072160342
43	9	53,00	1	072160343
44	10	53,00	1	072160344
45	10,5	53,00	1	072160345
46	11	53,00	1	072160346
47	12	53,00	1	072160347
48	13	53,00	1	072160348



EN 20345 S1P SRC

EN ISO 2011



7208RK

scarpe alte in pelle pieno fiore con suola in gomma

- Puntale in acciaio
- Lamina antiperforazione in fibra composita



EU	UK	€		
39	6	71,00	1	072080139
40	6,5	71,00	1	072080140
41	7	71,00	1	072080141
42	8	71,00	1	072080142
43	9	71,00	1	072080143
44	10	71,00	1	072080144
45	10,5	71,00	1	072080145
46	11	71,00	1	072080146
47	12	71,00	1	072080147



EN 20345 S3 HRO SRC

EN ISO 2011



7310BKK

scarpe "saldatore" stringate in pelle pieno fiore idrorepellente con rapido sfilamento e protezione frontale con chiusura a strappo.

Suola in gomma ad alta resistenza

- Puntale in acciaio
- Lamina antiperforazione in fibra composita

EN ISO 2011



EN 20345 S3 RS HRO SRC



EU	UK	€		
38	5	88,00	1	073100238
39	6	88,00	1	073100239
40	6,5	88,00	1	073100240
41	7	88,00	1	073100241
42	8	88,00	1	073100242
43	9	88,00	1	073100243
44	10	88,00	1	073100244
45	10,5	88,00	1	073100245
46	11	88,00	1	073100246
47	12	88,00	1	073100247

7329B

stivali in pelle pieno fiore idrorepellente con cerniera

- Puntale acciaio
- Lamina antiperforazione in acciaio inox

EN ISO 2011



EN 20345 S3 SRA



EU	UK	€		
38	5	60,00	1	073290538
39	6	60,00	1	073290539
40	6,5	60,00	1	073290540
41	7	60,00	1	073290541
42	8	60,00	1	073290542
43	9	60,00	1	073290543
44	10	60,00	1	073290544
45	10,5	60,00	1	073290545
46	11	60,00	1	073290546
47	12	60,00	1	073290547

7330B

stivali in pelle pieno fiore idrorepellente con cerniera, foderati in lana sintetica

- Puntale acciaio
- Lamina antiperforazione in acciaio inox

EN ISO 2011



EN 20345 S3 SRA



EU	UK	€		
38	5	62,00	1	073300538
39	6	62,00	1	073300539
40	6,5	62,00	1	073300540
41	7	62,00	1	073300541
42	8	62,00	1	073300542
43	9	62,00	1	073300543
44	10	62,00	1	073300544
45	10,5	62,00	1	073300545
46	11	62,00	1	073300546
47	12	62,00	1	073300547

 **Beta**

7254NA

scarpe in pelle scamosciata idrorepellente con inserti in nylon

- Puntale in composito
- Lamina antiperforazione in fibra composita



EU	UK	€		
38	5	62,00	1	072540138
39	6	62,00	1	072540139
40	6,5	62,00	1	072540140
41	7	62,00	1	072540141
42	8	62,00	1	072540142
43	9	62,00	1	072540143
44	10	62,00	1	072540144
45	10,5	62,00	1	072540145
46	11	62,00	1	072540146
47	12	62,00	1	072540147



EN 20345 S3 SRC

EN ISO 2011



7255NA

scarpe alte in pelle scamosciata idrorepellente con inserti in nylon

- Puntale in composito
- Lamina antiperforazione in fibra composita



EU	UK	€		
38	5	68,00	1	072550138
39	6	68,00	1	072550139
40	6,5	68,00	1	072550140
41	7	68,00	1	072550141
42	8	68,00	1	072550142
43	9	68,00	1	072550143
44	10	68,00	1	072550144
45	10,5	68,00	1	072550145
46	11	68,00	1	072550146
47	12	68,00	1	072550147



EN 20345 S3 SRC

EN ISO 2011



7263RK

scarpe basse in pelle scamosciata idrorepellente con inserti in pelle gofrata e suola in gomma HRO

- Puntale in alluminio con membrana traspirante
- Lamina antiperforazione in fibra composita



EU	UK	€		
38	5	84,00	1	072630138
39	6	84,00	1	072630139
40	6,5	84,00	1	072630140
41	7	84,00	1	072630141
42	8	84,00	1	072630142
43	9	84,00	1	072630143
44	10	84,00	1	072630144
45	10,5	84,00	1	072630145
46	11	84,00	1	072630146
47	12	84,00	1	072630147



EN 20345 S3 HRO SRC

EN ISO 2011



7264RK

scarpe alte in pelle scamosciata idrorepellente con inserti in pelle gofrata e suola in gomma HRO

- Puntale in alluminio con membrana traspirante
- Lamina antiperforazione in fibra composita



EU	UK	€		
38	5	87,50	1	072640138
39	6	87,50	1	072640139
40	6,5	87,50	1	072640140
41	7	87,50	1	072640141
42	8	87,50	1	072640142
43	9	87,50	1	072640143
44	10	87,50	1	072640144
45	10,5	87,50	1	072640145
46	11	87,50	1	072640146
47	12	87,50	1	072640147



EN 20345 S3 HRO SRC

EN ISO 2011



7250NKK

scarpe basse in pelle scamosciata idrorepellente con inserti in microfibra

- Puntale in materiale composito con membrana traspirante
- Lamina antiperforazione in fibra composita

EN ISO 2011



EN 20345 S1P SRC



EU	UK	€		
38	5	84,00	1	072500238
39	6	84,00	1	072500239
40	6,5	84,00	1	072500240
41	7	84,00	1	072500241
42	8	84,00	1	072500242
43	9	84,00	1	072500243
44	10	84,00	1	072500244
45	10,5	84,00	1	072500245
46	11	84,00	1	072500246
47	12	84,00	1	072500247

7251NKK

scarpe alte in pelle scamosciata idrorepellente con inserti in microfibra

- Puntale in materiale composito con membrana traspirante
- Lamina antiperforazione in fibra composita

EN ISO 2011



EN 20345 S1P SRC



EU	UK	€		
38	5	87,00	1	072510238
39	6	87,00	1	072510239
40	6,5	87,00	1	072510240
41	7	87,00	1	072510241
42	8	87,00	1	072510242
43	9	87,00	1	072510243
44	10	87,00	1	072510244
45	10,5	87,00	1	072510245
46	11	87,00	1	072510246
47	12	87,00	1	072510247

7252NKK

scarpe basse in pelle nabuk idrorepellente con inserti in microfibra idrorepellente

- Puntale in materiale composito con membrana traspirante
- Lamina antiperforazione in fibra composita

EN ISO 2011



EN 20345 S3 SRC



EU	UK	€		
38	5	99,00	1	072520138
39	6	99,00	1	072520139
40	6,5	99,00	1	072520140
41	7	99,00	1	072520141
42	8	99,00	1	072520142
43	9	99,00	1	072520143
44	10	99,00	1	072520144
45	10,5	99,00	1	072520145
46	11	99,00	1	072520146
47	12	99,00	1	072520147

Beta

7290AKK

scarpe in pelle pieno fiore idrorepellente ad alta traspirazione

- Puntale in composito
- Lamina antiperforazione in fibra composita



EU	UK	€		
38	5	119,00	1	072900238
39	6	119,00	1	072900239
40	6,5	119,00	1	072900240
41	7	119,00	1	072900241
42	8	119,00	1	072900242
43	9	119,00	1	072900243
44	10	119,00	1	072900244
45	10,5	119,00	1	072900245
46	11	119,00	1	072900246
47	12	119,00	1	072900247
48	13	119,00	1	072900248



EN 20345 S3 SRC

7291AKK

scarpe alte in pelle pieno fiore idrorepellente ad alta traspirazione

- Puntale in composito
- Lamina antiperforazione in fibra composita



EU	UK	€		
38	5	127,00	1	072910238
39	6	127,00	1	072910239
40	6,5	127,00	1	072910240
41	7	127,00	1	072910241
42	8	127,00	1	072910242
43	9	127,00	1	072910243
44	10	127,00	1	072910244
45	10,5	127,00	1	072910245
46	11	127,00	1	072910246
47	12	127,00	1	072910247
48	13	127,00	1	072910248



EN 20345 S3 SRC

7293RK

scarpe in pelle Nabuk ingrassata con torsion control e suola in gomma ad alta resistenza

- Puntale in acciaio
- Lamina antiperforazione in fibra composita



EU	UK	€		
39	6	110,00	1	072930339
40	6,5	110,00	1	072930340
41	7	110,00	1	072930341
42	8	110,00	1	072930342
43	9	110,00	1	072930343
44	10	110,00	1	072930344
45	10,5	110,00	1	072930345
46	11	110,00	1	072930346
47	12	110,00	1	072930347



EN 20345 S3 HRO SRC

7294RK

scarpe alte in pelle Nabuk ingrassata con torsion control e suola in gomma ad alta resistenza

- Puntale in acciaio
- Lamina antiperforazione in fibra composita



EU	UK	€		
39	6	115,00	1	072940339
40	6,5	115,00	1	072940340
41	7	115,00	1	072940341
42	8	115,00	1	072940342
43	9	115,00	1	072940343
44	10	115,00	1	072940344
45	10,5	115,00	1	072940345
46	11	115,00	1	072940346
47	12	115,00	1	072940347



EN 20345 S3 HRO SRC

7293NKK

scarpe in pelle Nabuk ingrassata
con dynamic control e suola in gomma VIBRAM®
ad alta resistenza

- Puntale in composito
- Lamina antiperforazione in fibra composita

EN ISO 2011



EU	UK	€	
38	5	137,00	1 072930138
39	6	137,00	1 072930139
40	6,5	137,00	1 072930140
41	7	137,00	1 072930141
42	8	137,00	1 072930142
43	9	137,00	1 072930143
44	10	137,00	1 072930144
45	10,5	137,00	1 072930145
46	11	137,00	1 072930146
47	12	137,00	1 072930147
48	13	137,00	1 072930148



EN 20345 S3 HRO SRC

7294NKK

scarpe alte in pelle Nabuk ingrassata
con dynamic control e suola in gomma VIBRAM® ad alta
resistenza

- Puntale in composito
- Lamina antiperforazione in fibra composita

EN ISO 2011



EU	UK	€	
38	5	145,00	1 072940138
39	6	145,00	1 072940139
40	6,5	145,00	1 072940140
41	7	145,00	1 072940141
42	8	145,00	1 072940142
43	9	145,00	1 072940143
44	10	145,00	1 072940144
45	10,5	145,00	1 072940145
46	11	145,00	1 072940146
47	12	145,00	1 072940147
48	13	145,00	1 072940148



EN 20345 S3 HRO SRC

7293TKK

scarpe in pelle Nabuk ingrassata
con membrana in Thinsulate™, dynamic control e suola in
gomma VIBRAM® ad alta resistenza

- Puntale in composito
- Lamina antiperforazione in fibra composita

EN ISO 2011



EU	UK	€	
38	5	138,00	1 072930238
39	6	138,00	1 072930239
40	6,5	138,00	1 072930240
41	7	138,00	1 072930241
42	8	138,00	1 072930242
43	9	138,00	1 072930243
44	10	138,00	1 072930244
45	10,5	138,00	1 072930245
46	11	138,00	1 072930246
47	12	138,00	1 072930247
48	13	138,00	1 072930248



EN 20345 S3 HRO SRC

7294TKK

scarpe alte in pelle Nabuk ingrassata
con membrana in Thinsulate™, dynamic control e suola in
gomma VIBRAM® ad alta resistenza

- Puntale in composito
- Lamina antiperforazione in fibra composita

EN ISO 2011



EU	UK	€	
38	5	146,00	1 072940238
39	6	146,00	1 072940239
40	6,5	146,00	1 072940240
41	7	146,00	1 072940241
42	8	146,00	1 072940242
43	9	146,00	1 072940243
44	10	146,00	1 072940244
45	10,5	146,00	1 072940245
46	11	146,00	1 072940246
47	12	146,00	1 072940247
48	13	146,00	1 072940248



EN 20345 S3 HRO SRC

7239V

scarpe alte in pelle pieno fiore idrorepellente con suola in gomma VIBRAM® ad alta resistenza

- Puntale in composito
- Lamina antiperforazione in fibra composita



EU	UK	€		
38	5	160,00	1	072390138
39	6	160,00	1	072390139
40	6,5	160,00	1	072390140
41	7	160,00	1	072390141
42	8	160,00	1	072390142
43	9	160,00	1	072390143
44	10	160,00	1	072390144
45	10,5	160,00	1	072390145
46	11	160,00	1	072390146
47	12	160,00	1	072390147
48	13	160,00	1	072390148



EN 20345 S3 HRO SRC

7295TNV

polacchini in pelle pieno fiore idrorepellente con membrana in Thinsulate™ e suola in gomma VIBRAM® ad alta resistenza

- Puntale in composito
- Lamina antiperforazione in fibra composita



EU	UK	€		
38	5	173,00	1	072950038
39	6	173,00	1	072950039
40	6,5	173,00	1	072950040
41	7	173,00	1	072950041
42	8	173,00	1	072950042
43	9	173,00	1	072950043
44	10	173,00	1	072950044
45	10,5	173,00	1	072950045
46	11	173,00	1	072950046
47	12	173,00	1	072950047
48	13	173,00	1	072950048



EN 20345 S3 HRO SRC

7326NKK

scarpe alte waterproof in pelle con membrana termosaldata idrorepellente e suola in gomma ad alta resistenza

- Puntale in composito
- Lamina antiperforazione in fibra composita



EU	UK	€		
39	6	146,00	1	073260039
40	6,5	146,00	1	073260040
41	7	146,00	1	073260041
42	8	146,00	1	073260042
43	9	146,00	1	073260043
44	10	146,00	1	073260044
45	10,5	146,00	1	073260045
46	11	146,00	1	073260046
47	12	146,00	1	073260047



EN 20345 S3 HRO SRA

7330NV

stivali in pelle nabuk ingrassata idrorepellente con membrana in Thinsulate™ e suola in gomma VIBRAM® ad alta resistenza. Foderati in pelliccia di vera lana

- Puntale in composito
- Lamina antiperforazione in fibra composita



EU	UK	€		
38	5	173,00	1	073300438
39	6	173,00	1	073300439
40	6,5	173,00	1	073300440
41	7	173,00	1	073300441
42	8	173,00	1	073300442
43	9	173,00	1	073300443
44	10	173,00	1	073300444
45	10,5	173,00	1	073300445
46	11	173,00	1	073300446
47	12	173,00	1	073300447
48	13	173,00	1	073300448



EN 20345 S3 HRO SRC

7327NKK

stivali "POLAR" in pelle pieno fiore idrorepellente, con scarpetta estraibile

- Puntale in composito
- Lamina antiperforazione in fibra composita

EN ISO 2011



EU	UK	€		
39	6	168,00	1	073270039
40	6,5	168,00	1	073270040
41	7	168,00	1	073270041
42	8	168,00	1	073270042
43	9	168,00	1	073270043
44	10	168,00	1	073270044
45	10,5	168,00	1	073270045
46	11	168,00	1	073270046



EN 20345 S3 HRO SRA

7327R

scarpette interne per stivali 7327NKK



EU	UK	€		
39	6	52,00	1	073270939
40	6,5	52,00	1	073270940
41	7	52,00	1	073270941
42	8	52,00	1	073270942
43	9	52,00	1	073270943
44	10	52,00	1	073270944
45	10,5	52,00	1	073270945
46	11	52,00	1	073270946



7328EA

stivali di sicurezza "alta visibilità"

- Puntale in acciaio
- Lamina antiperforazione in acciaio elastico

EN ISO 2011



EU	UK	€		
38	5	28,00	1	073280538
39	6	28,00	1	073280539
40	6,5	28,00	1	073280540
41	7	28,00	1	073280541
42	8	28,00	1	073280542
43	9	28,00	1	073280543
44	10	28,00	1	073280544
45	10,5	28,00	1	073280545
46	11	28,00	1	073280546
47	12	28,00	1	073280547



EN 20345 S5 SRC

7328EN

stivali di sicurezza

- Puntale in acciaio
- Lamina antiperforazione in acciaio elastico

EN ISO 2011



EU	UK	€		
38	5	28,00	1	073280738
39	6	28,00	1	073280739
40	6,5	28,00	1	073280740
41	7	28,00	1	073280741
42	8	28,00	1	073280742
43	9	28,00	1	073280743
44	10	28,00	1	073280744
45	10,5	28,00	1	073280745
46	11	28,00	1	073280746
47	12	28,00	1	073280747



EN 20345 S5 SRC

7300B

scarpe "free time" in pelle pieno fiore idrorepellente, senza puntale e lamina antiperforazione

- Senza puntale
- Senza lamina antiperforazione



EU	UK	€		
36	3,5	110,00	1	073000536
37	4,5	110,00	1	073000537
38	5	110,00	1	073000538
39	6	110,00	1	073000539
40	6,5	110,00	1	073000540
41	7	110,00	1	073000541
42	8	110,00	1	073000542
43	9	110,00	1	073000543
44	10	110,00	1	073000544
45	10,5	110,00	1	073000545
46	11	110,00	1	073000546
47	12	110,00	1	073000547
48	13	110,00	1	073000548



EN 20347 O2 FO SRC

7300BKK

scarpe in pelle pieno fiore ad alta traspirazione

- Puntale in composito
- Lamina antiperforazione in fibra composita



EU	UK	€		
36	3,5	110,00	1	073000236
37	4,5	110,00	1	073000237
38	5	110,00	1	073000238
39	6	110,00	1	073000239
40	6,5	110,00	1	073000240
41	7	110,00	1	073000241
42	8	110,00	1	073000242
43	9	110,00	1	073000243
44	10	110,00	1	073000244
45	10,5	110,00	1	073000245
46	11	110,00	1	073000246
47	12	110,00	1	073000247
48	13	110,00	1	073000248



EN 20345 S3 SRC

7318ESD

scarpe in pelle scamosciata traforata, ESD

- Puntale in composito
- Lamina antiperforazione in fibra composita



EU	UK	€		
36	3,5	115,00	1	073180136
37	4,5	115,00	1	073180137
38	5	115,00	1	073180138
39	6	115,00	1	073180139
40	6,5	115,00	1	073180140
41	7	115,00	1	073180141
42	8	115,00	1	073180142
43	9	115,00	1	073180143
44	10	115,00	1	073180144
45	10,5	115,00	1	073180145
46	11	115,00	1	073180146
47	12	115,00	1	073180147
48	13	115,00	1	073180148



EN 20345 S1P SRC

Beta



7313KK

scarpe "light" in pelle scamosciata ed inserti in mesh, suola racing

- Puntale in composito
- Lamina antiperforazione in fibra composita

EN ISO 2011



EN 20345 S1P SRC



EU	UK	€		
35	2,5	62,00	1	073130335
36	3,5	62,00	1	073130336
37	4,5	62,00	1	073130337
38	5	62,00	1	073130338
39	6	62,00	1	073130339
40	6,5	62,00	1	073130340
41	7	62,00	1	073130341
42	8	62,00	1	073130342
43	9	62,00	1	073130343
44	10	62,00	1	073130344
45	10,5	62,00	1	073130345
46	11	62,00	1	073130346
47	12	62,00	1	073130347
48	13	62,00	1	073130348

7313KKB

scarpe "light" in pelle scamosciata ed inserti in mesh, suola racing

- Puntale in composito
- Lamina antiperforazione in fibra composita

EN ISO 2011



EN 20345 S1P SRC



EU	UK	€		
35	2,5	62,00	1	073130435
36	3,5	62,00	1	073130436
37	4,5	62,00	1	073130437
38	5	62,00	1	073130438
39	6	62,00	1	073130439
40	6,5	62,00	1	073130440
41	7	62,00	1	073130441
42	8	62,00	1	073130442
43	9	62,00	1	073130443
44	10	62,00	1	073130444
45	10,5	62,00	1	073130445
46	11	62,00	1	073130446
47	12	62,00	1	073130447
48	13	62,00	1	073130448

7313KKC

scarpe "light" in materiale antiabrasione con inserti in carbon e mesh, suola racing

- Puntale in composito
- Lamina antiperforazione in fibra composita

EN ISO 2011



EN 20345 S1P SRC



EU	UK	€		
35	2,5	65,00	1	073130535
36	3,5	65,00	1	073130536
37	4,5	65,00	1	073130537
38	5	65,00	1	073130538
39	6	65,00	1	073130539
40	6,5	65,00	1	073130540
41	7	65,00	1	073130541
42	8	65,00	1	073130542
43	9	65,00	1	073130543
44	10	65,00	1	073130544
45	10,5	65,00	1	073130545
46	11	65,00	1	073130546
47	12	65,00	1	073130547
48	13	65,00	1	073130548

7314KK

scarpe "light" in pelle scamosciata, suola racing

- Puntale in composito
- Lamina antiperforazione in fibra composita

EN ISO 2011



EN 20345 S1P SRC



EU	UK	€		
35	2,5	62,00	1	073140135
36	3,5	62,00	1	073140136
37	4,5	62,00	1	073140137
38	5	62,00	1	073140138
39	6	62,00	1	073140139
40	6,5	62,00	1	073140140
41	7	62,00	1	073140141
42	8	62,00	1	073140142
43	9	62,00	1	073140143
44	10	62,00	1	073140144
45	10,5	62,00	1	073140145
46	11	62,00	1	073140146
47	12	62,00	1	073140147
48	13	62,00	1	073140148

7334KK

mocassini "light" in morbida pelle scamosciata, suola racing

- Puntale in composito
- Lamina antiperforazione in fibra composita

EN ISO 2011



EU	UK	€		
35	2,5	61,00	1	073340235
36	3,5	61,00	1	073340236
37	4,5	61,00	1	073340237
38	5	61,00	1	073340238
39	6	61,00	1	073340239
40	6,5	61,00	1	073340240
41	7	61,00	1	073340241
42	8	61,00	1	073340242
43	9	61,00	1	073340243
44	10	61,00	1	073340244
45	10,5	61,00	1	073340245
46	11	61,00	1	073340246
47	12	61,00	1	073340247
48	13	61,00	1	073340248



EN 20345 S1P SRC

7320KK

scarpe "light" in pelle nabuk idrorepellente, suola racing

- Puntale in composito
- Lamina antiperforazione in fibra composita

EN ISO 2011



EU	UK	€		
35	2,5	81,00	1	073200235
36	3,5	81,00	1	073200236
37	4,5	81,00	1	073200237
38	5	81,00	1	073200238
39	6	81,00	1	073200239
40	6,5	81,00	1	073200240
41	7	81,00	1	073200241
42	8	81,00	1	073200242
43	9	81,00	1	073200243
44	10	81,00	1	073200244
45	10,5	81,00	1	073200245
46	11	81,00	1	073200246
47	12	81,00	1	073200247
48	13	81,00	1	073200248



EN 20345 S3 SRC

7316KK

scarpe "light" in pelle pieno fiore bottalata idrorepellente, suola racing

- Puntale in composito
- Lamina antiperforazione in fibra composita

EN ISO 2011



EU	UK	€		
35	2,5	79,00	1	073160235
36	3,5	79,00	1	073160236
37	4,5	79,00	1	073160237
38	5	79,00	1	073160238
39	6	79,00	1	073160239
40	6,5	79,00	1	073160240
41	7	79,00	1	073160241
42	8	79,00	1	073160242
43	9	79,00	1	073160243
44	10	79,00	1	073160244
45	10,5	79,00	1	073160245
46	11	79,00	1	073160246
47	12	79,00	1	073160247
48	13	79,00	1	073160248



EN 20345 S3 SRC

Beta



7344RP

scarpe in pelle "VINTAGE" ingrassata e idrorepellente con suola in gomma e anello in morbido PU

- Puntale in composito
- Lamina antiperforazione in fibra composita

EN ISO 2011



EN 20345 S3 HRO SRC



EU	UK	€		
38	5	124,00	1	073440138
39	6	124,00	1	073440139
40	6,5	124,00	1	073440140
41	7	124,00	1	073440141
42	8	124,00	1	073440142
43	9	124,00	1	073440143
44	10	124,00	1	073440144
45	10,5	124,00	1	073440145
46	11	124,00	1	073440146
47	12	124,00	1	073440147

7345RP

scarpe alte in pelle "VINTAGE" ingrassata e idrorepellente con suola in gomma e anello in morbido PU

- Puntale in composito
- Lamina antiperforazione in fibra composita

EN ISO 2011



EN 20345 S3 HRO SRC



EU	UK	€		
38	5	127,00	1	073450138
39	6	127,00	1	073450139
40	6,5	127,00	1	073450140
41	7	127,00	1	073450141
42	8	127,00	1	073450142
43	9	127,00	1	073450143
44	10	127,00	1	073450144
45	10,5	127,00	1	073450145
46	11	127,00	1	073450146
47	12	127,00	1	073450147

7349RP

scarpe in crosta nabukata idrorepellente con suola in gomma e anello in morbido PU

- Puntale in composito
- Lamina antiperforazione in fibra composita

EN ISO 2011



EN 20345 S3 HRO SRC



EU	UK	€		
38	5	124,00	1	073490138
39	6	124,00	1	073490139
40	6,5	124,00	1	073490140
41	7	124,00	1	073490141
42	8	124,00	1	073490142
43	9	124,00	1	073490143
44	10	124,00	1	073490144
45	10,5	124,00	1	073490145
46	11	124,00	1	073490146
47	12	124,00	1	073490147

7350RP

scarpe alte in crosta nabukata idrorepellente con suola in gomma e anello in morbido PU

- Puntale in composito
- Lamina antiperforazione in fibra composita

EN ISO 2011



EN 20345 S3 HRO SRC



EU	UK	€		
38	5	127,00	1	073500138
39	6	127,00	1	073500139
40	6,5	127,00	1	073500140
41	7	127,00	1	073500141
42	8	127,00	1	073500142
43	9	127,00	1	073500143
44	10	127,00	1	073500144
45	10,5	127,00	1	073500145
46	11	127,00	1	073500146
47	12	127,00	1	073500147

7346RP

mocassini in pelle scamosciata con inserti in mesh, chiusura a strappo, suola in gomma e anello in morbido PU

- Puntale in composito
- Lamina antiperforazione in fibra composita

EN ISO 2011



EU	UK	€		
38	5	113,00	1	073460138
39	6	113,00	1	073460139
40	6,5	113,00	1	073460140
41	7	113,00	1	073460141
42	8	113,00	1	073460142
43	9	113,00	1	073460143
44	10	113,00	1	073460144
45	10,5	113,00	1	073460145
46	11	113,00	1	073460146
47	12	113,00	1	073460147



EN 20345 S1P HRO SRC

7347RP

scarpe in pelle scamosciata traforata con suola in gomma e anello in morbido PU

- Puntale in composito
- Lamina antiperforazione in fibra composita

EN ISO 2011



EU	UK	€		
38	5	113,00	1	073470138
39	6	113,00	1	073470139
40	6,5	113,00	1	073470140
41	7	113,00	1	073470141
42	8	113,00	1	073470142
43	9	113,00	1	073470143
44	10	113,00	1	073470144
45	10,5	113,00	1	073470145
46	11	113,00	1	073470146
47	12	113,00	1	073470147



EN 20345 S1P HRO SRC

7348RP

scarpe in pelle scamosciata con inserti in mesh, suola in gomma e anello in morbido PU

- Puntale in composito
- Lamina antiperforazione in fibra composita

EN ISO 2011



EU	UK	€		
38	5	120,00	1	073480138
39	6	120,00	1	073480139
40	6,5	120,00	1	073480140
41	7	120,00	1	073480141
42	8	120,00	1	073480142
43	9	120,00	1	073480143
44	10	120,00	1	073480144
45	10,5	120,00	1	073480145
46	11	120,00	1	073480146
47	12	120,00	1	073480147



EN 20345 S1P HRO SRC

 **Beta**



7360BKK

scarpe basse in pelle scamosciata con inserti in canvas

- Puntale in alluminio con membrana traspirante
- Lamina antiperforazione in fibra composita

EN ISO 2011



EU	UK	€		
38	5	80,00	1	073600238
39	6	80,00	1	073600239
40	6,5	80,00	1	073600240
41	7	80,00	1	073600241
42	8	80,00	1	073600242
43	9	80,00	1	073600243
44	10	80,00	1	073600245
45	10,5	80,00	1	073600244
46	11	80,00	1	073600246
47	12	80,00	1	073600247



EN 20345 S1P SRC

7361DKK

scarpe basse in pelle scamosciata con inserti in canvas

- Puntale in alluminio con membrana traspirante
- Lamina antiperforazione in fibra composita

EN ISO 2011



EU	UK	€		
38	5	80,00	1	073610038
39	6	80,00	1	073610039
40	6,5	80,00	1	073610040
41	7	80,00	1	073610041
42	8	80,00	1	073610042
43	9	80,00	1	073610043
44	10	80,00	1	073610044
45	10,5	80,00	1	073610045
46	11	80,00	1	073610046
47	12	80,00	1	073610047



EN 20345 S1P SRC

7361GKK

scarpe basse in pelle scamosciata con inserti in canvas

- Puntale in alluminio con membrana traspirante
- Lamina antiperforazione in fibra composita

EN ISO 2011



EU	UK	€		
38	5	80,00	1	073610138
39	6	80,00	1	073610139
40	6,5	80,00	1	073610140
41	7	80,00	1	073610141
42	8	80,00	1	073610142
43	9	80,00	1	073610143
44	10	80,00	1	073610144
45	10,5	80,00	1	073610145
46	11	80,00	1	073610146
47	12	80,00	1	073610147



EN 20345 S1P SRC

7365GKK

scarpe alte in pelle scamosciata con inserti in canvas

- Puntale in alluminio con membrana traspirante
- Lamina antiperforazione in fibra composita

EN ISO 2011



EU	UK	€		
38	5	86,00	1	073650138
39	6	86,00	1	073650139
40	6,5	86,00	1	073650140
41	7	86,00	1	073650141
42	8	86,00	1	073650142
43	9	86,00	1	073650143
44	10	86,00	1	073650144
45	10,5	86,00	1	073650145
46	11	86,00	1	073650146
47	12	86,00	1	073650147



EN 20345 S1P SRC

7367G

scarpe alte in pelle "VINTAGE" ingrassata e idrorepellente, senza puntale e lamina antiperforazione

- Senza puntale
- Senza lamina antiperforazione



EU	UK	€		
38	5	79,00	1	073670038
39	6	79,00	1	073670039
40	6,5	79,00	1	073670040
41	7	79,00	1	073670041
42	8	79,00	1	073670042
43	9	79,00	1	073670043
44	10	79,00	1	073670044
45	10,5	79,00	1	073670045
46	11	79,00	1	073670046
47	12	79,00	1	073670047



EN 20347 O2 SRC



7368NKK

scarpe alte in pelle "VINTAGE" ingrassata e idrorepellente

- Puntale in alluminio con membrana traspirante
- Lamina antiperforazione in fibra composita



EU	UK	€		
38	5	91,00	1	073680038
39	6	91,00	1	073680039
40	6,5	91,00	1	073680040
41	7	91,00	1	073680041
42	8	91,00	1	073680042
43	9	91,00	1	073680043
44	10	91,00	1	073680044
45	10,5	91,00	1	073680045
46	11	91,00	1	073680046
47	12	91,00	1	073680047



EN 20345 S3 SRC



7368BKK

scarpe alte in pelle "VINTAGE" ingrassata e idrorepellente

- Puntale in alluminio con membrana traspirante
- Lamina antiperforazione in fibra composita



EU	UK	€		
38	5	91,00	1	073680138
39	6	91,00	1	073680139
40	6,5	91,00	1	073680140
41	7	91,00	1	073680141
42	8	91,00	1	073680142
43	9	91,00	1	073680143
44	10	91,00	1	073680144
45	10,5	91,00	1	073680145
46	11	91,00	1	073680146
47	12	91,00	1	073680147



EN 20345 S3 SRC



7368GKK

scarpe alte in pelle "VINTAGE" ingrassata e idrorepellente

- Puntale in alluminio con membrana traspirante
- Lamina antiperforazione in fibra composita



EU	UK	€		
38	5	91,00	1	073680238
39	6	91,00	1	073680239
40	6,5	91,00	1	073680240
41	7	91,00	1	073680241
42	8	91,00	1	073680242
43	9	91,00	1	073680243
44	10	91,00	1	073680244
45	10,5	91,00	1	073680245
46	11	91,00	1	073680246
47	12	91,00	1	073680247



EN 20345 S3 SRC



7369BKK

scarpe alte in pelle "VINTAGE" ingrassata idrorepellente con inserti in tessuto tecnico camouflage

- Puntale in alluminio con membrana traspirante
- Lamina antiperforazione in fibra composita

EN ISO 2011



EN 20345 S3 SRC



EU	UK	€		
38	5	96,00	1	073690038
39	6	96,00	1	073690039
40	6,5	96,00	1	073690040
41	7	96,00	1	073690041
42	8	96,00	1	073690042
43	9	96,00	1	073690043
44	10	96,00	1	073690044
45	10,5	96,00	1	073690045
46	11	96,00	1	073690046
47	12	96,00	1	073690047

7369GKK

scarpe alte in pelle nabuk bottalato idrorepellente con inserti in tessuto tecnico camouflage

- Puntale in alluminio con membrana traspirante
- Lamina antiperforazione in fibra composita

EN ISO 2011



EN 20345 S3 SRC



EU	UK	€		
38	5	99,50	1	073690138
39	6	99,50	1	073690139
40	6,5	99,50	1	073690140
41	7	99,50	1	073690141
42	8	99,50	1	073690142
43	9	99,50	1	073690143
44	10	99,50	1	073690144
45	10,5	99,50	1	073690145
46	11	99,50	1	073690146
47	12	99,50	1	073690147



7398 TNT

sottopiedi intercambiabili in CARBON



EU	UK	€	👤	📦
35	2,5	2,80	1	073980035
36	3,5	2,80	1	073980036
37	4,5	2,80	1	073980037
38	5	2,80	1	073980038
39	6	2,80	1	073980039
40	6,5	2,80	1	073980040
41	7	2,80	1	073980041
42	8	2,80	1	073980042
43	9	2,80	1	073980043
44	10	2,80	1	073980044
45	10,5	2,80	1	073980045
46	11	2,80	1	073980046
47	12	2,80	1	073980047
48	13	2,80	1	073980048

7398BF

sottopiedi anatomici "BLOW-FEET"



EU	UK	€	👤	📦
36	3,5	12,00	1	073980336
37	4,5	12,00	1	073980337
38	5	12,00	1	073980338
39	6	12,00	1	073980339
40	6,5	12,00	1	073980340
41	7	12,00	1	073980341
42	8	12,00	1	073980342
43	9	12,00	1	073980343
44	10	12,00	1	073980344
45	10,5	12,00	1	073980345
46	11	12,00	1	073980346
47	12	12,00	1	073980347
48	13	12,00	1	073980348

7398ST

sottopiedi anatomici On Steam



EU	UK	€	👤	📦
35	2,5	9,00	1	073981035
36	3,5	9,00	1	073981036
37	4,5	9,00	1	073981037
38	5	9,00	1	073981038
39	6	9,00	1	073981039
40	6,5	9,00	1	073981040
41	7	9,00	1	073981041
42	8	9,00	1	073981042
43	9	9,00	1	073981043
44	10	9,00	1	073981044
45	10,5	9,00	1	073981045
46	11	9,00	1	073981046
47	12	9,00	1	073981047
48	13	9,00	1	073981048

7398GEL

sottopiedi anatomici con inserto in gel



EU	UK	€	👤	📦
35	2,5	2,90	1	073980835
36	3,5	2,90	1	073980836
37	4,5	2,90	1	073980837
38	5	2,90	1	073980838
39	6	2,90	1	073980839
40	6,5	2,90	1	073980840
41	7	2,90	1	073980841
42	8	2,90	1	073980842
43	9	2,90	1	073980843
44	10	2,90	1	073980844
45	10,5	2,90	1	073980845
46	11	2,90	1	073980846
47	12	2,90	1	073980847
48	13	2,90	1	073980848

7398CX

sottopiedi anatomici Coolmax®



EU	UK	€	👤	📦
35	2,5	8,00	1	073980935
36	3,5	8,00	1	073980936
37	4,5	8,00	1	073980937
38	5	8,00	1	073980938
39	6	8,00	1	073980939
40	6,5	8,00	1	073980940
41	7	8,00	1	073980941
42	8	8,00	1	073980942
43	9	8,00	1	073980943
44	10	8,00	1	073980944
45	10,5	8,00	1	073980945
46	11	8,00	1	073980946
47	12	8,00	1	073980947
48	13	8,00	1	073980948

7398AL

sottopiedi per basse temperature in feltro alluminizzato



EU	UK	€	👤	📦
38	5	10,50	1	073980538
39	6	10,50	1	073980539
40	6,5	10,50	1	073980540
41	7	10,50	1	073980541
42	8	10,50	1	073980542
43	9	10,50	1	073980543
44	10	10,50	1	073980544
45	10,5	10,50	1	073980545
46	11	10,50	1	073980546
47	12	10,50	1	073980547
48	13	10,50	1	073980548

7399 A/N...

confezione 10 paia di stringhe



	cm	€		
7399 A/N100	100	12,20	1	073990010
7399 A/N120	120	14,30	1	073990012
7399 A/N140	140	18,40	1	073990017

I prezzi indicati sono relativi a 10 paia

7399G...

confezione 10 paia di stringhe grigie



	cm	€		
7399G 110	110	10,00	1	073990018

I prezzi indicati sono relativi a 10 paia

7399M...

confezione 10 paia di stringhe marroni

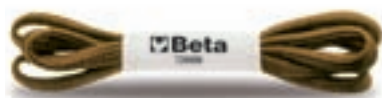

	cm	€		
7399M 90	90	11,20	1	073990013
7399M 120	120	14,30	1	073990014

I prezzi indicati sono relativi a 10 paia

7399B...

confezione 10 paia di stringhe beige



	cm	€		
7399B 90	90	11,20	1	073990015
7399B 120	120	14,30	1	073990016

I prezzi indicati sono relativi a 10 paia

7410

calzini in polipropilene con piede in cotone e Cupron®



	EU	€		
S	37-39	16,50	1	074100001
M	40-42	16,50	1	074100002
L	43-45	16,50	1	074100003
XL	46-48	16,50	1	074100004

7413

calzini in spugna e poliammide.
calzata destra e sinistra



	EU	€		
S	37-39	10,00	1	074130001
M	40-42	10,00	1	074130002
L	43-45	10,00	1	074130003
XL	46-48	10,00	1	074130004

7415

calzini in Coolmax®, Dryarn® e Cordura®



	EU	€		
S	37-39	11,50	1	074150001
M	40-42	11,50	1	074150002
L	43-45	11,50	1	074150003
XL	46-48	11,50	1	074150004

7416

calze in Coolmax®, Dryarn® e Cordura®



	EU	€		
S	37-39	12,50	1	074160001
M	40-42	12,50	1	074160002
L	43-45	12,50	1	074160003
XL	46-48	12,50	1	074160004

7417

calzini in Tactel®



	EU	€		
S	37-39	9,00	1	074170001
M	40-42	9,00	1	074170002
L	43-45	9,00	1	074170003
XL	46-48	9,00	1	074170004

7418

calzini in Meryl Skinlife® antibatterico



	EU	€		
S	37-39	9,00	1	074180001
M	40-42	9,00	1	074180002
L	43-45	9,00	1	074180003
XL	46-48	9,00	1	074180004

Beta



La linea di abbigliamento da lavoro ha conquistato nel corso degli anni la fiducia e la preferenza dei professionisti più esigenti. Il successo del prodotto ha generato la costante evoluzione e l'ampliamento della gamma di offerta.

I capi di abbigliamento prodotti da Beta Utensili S.p.a. sono conformi alla seguente normativa:

EN 340/1

Il DPI protegge l'utilizzatore dai rischi fisici di lieve entità come: piccole abrasioni, raggi solari, vento, freddo polveri non nocive ed imbrattamento da materiali non tossici. Tale protezione è riconducibile alla prima categoria del DDL 475 del 04/12/1992.

ISTRUZIONI PER L'UTILIZZO E LA CONSERVAZIONE

Il capo va indossato correttamente in modo che possa proteggere le parti del corpo dell'utilizzatore. Il capo va conservato in un luogo fresco ed asciutto, nel suo imballaggio originale, al riparo da fonti di calore, luce solare, polvere ed agenti atmosferici.

CONFEZIONAMENTO

- **ABBIGLIAMENTO DA LAVORO:** busta appendibile
- **ABBIGLIAMENTO TEMPO LIBERO:** busta non appendibile

RESTRINGIMENTO

Tutte le fibre naturali si restringono dopo il lavaggio in acqua. Il restringimento può variare dall'1% al 5% in funzione di diversi parametri, in particolare il tipo di fibra e la temperatura dell'acqua.



	I	F	D	E	UK	USA
XS	46	38	42	40	30	32
S	48	40	44	42	32	34
M	50	42	46	44	34	36
L	52	44	48	46	36	38
XL	54	46	50	48	38	40
XXL	56	48	52	50	40	42
XXXL	58	50	54	52	42	44
4XL	60	52	56	54	44	46

Beta EN340/1

	XS	S	M	L	XL	2XL	3XL	4XL
A	88-92	92-96	96-104	104-108	108-116	116-124	124-132	132-140
B	79-83	83-87	87-91	91-95	95-100	100-107	107-112	112-120
H	156-164	164-170	170-178	178-182	182-188	188-194	194-200	200-206



7505DG

pantaloni multitasche in 100% cotone twill
prelavato 260 g, verde militare

CE



	€		
XS	78,50	1	075050046
S	78,50	1	075050048
M	78,50	1	075050050
L	78,50	1	075050052
XL	78,50	1	075050054
XXL	78,50	1	075050056
XXXL	78,50	1	075050058

7505B

pantaloni multitasche in 100% cotone twill
prelavato 260 g, beige

CE



	€		
XS	78,50	1	075050146
S	78,50	1	075050148
M	78,50	1	075050150
L	78,50	1	075050152
XL	78,50	1	075050154
XXL	78,50	1	075050156
XXXL	78,50	1	075050158

7505M

pantaloni multitasche mimetici
in 100% cotone twill 260 g

CE



	€		
XS	78,50	1	075050246
S	78,50	1	075050248
M	78,50	1	075050250
L	78,50	1	075050252
XL	78,50	1	075050254
XXL	78,50	1	075050256
XXXL	78,50	1	075050258

7525

jeans da lavoro elasticizzati prelavati
in 68% cotone denim, 29% poliestere,
3% tessuto elasticizzato, 100Z

CE



	€		
XS	44,00	1	075250046
S	44,00	1	075250048
M	44,00	1	075250050
L	44,00	1	075250052
XL	44,00	1	075250054
XXL	44,00	1	075250056
XXXL	44,00	1	075250058

7515DG

bermuda multitasche in 100% cotone twill
prelavato 260 g, verde militare

CE



	€		
XS	66,00	1	075150046
S	66,00	1	075150048
M	66,00	1	075150050
L	66,00	1	075150052
XL	66,00	1	075150054
XXL	66,00	1	075150056
XXXL	66,00	1	075150058

7515B

bermuda multitasche in 100% cotone twill
prelavato 260 g, beige

CE



	€		
XS	66,00	1	075150146
S	66,00	1	075150148
M	66,00	1	075150150
L	66,00	1	075150152
XL	66,00	1	075150154
XXL	66,00	1	075150156
XXXL	66,00	1	075150158

7515M

bermuda multitasche mimetici
in 100% cotone twill 260 g

CE



	€		
XS	66,00	1	075150246
S	66,00	1	075150248
M	66,00	1	075150250
L	66,00	1	075150252
XL	66,00	1	075150254
XXL	66,00	1	075150256
XXXL	66,00	1	075150258

7546BL

polo 3 bottoni
in cotone piqué 220 g, blu

CE



taglia	€	pacchetto	codice
XS	30,00	2	075460000
S	30,00	2	075460001
M	30,00	2	075460002
L	30,00	2	075460003
XL	30,00	2	075460004
XXL	30,00	2	075460005
XXXL	30,00	2	075460006

75460

polo 3 bottoni
in cotone piqué 220 g, arancio

CE



taglia	€	pacchetto	codice
XS	30,00	2	075460300
S	30,00	2	075460301
M	30,00	2	075460302
L	30,00	2	075460303
XL	30,00	2	075460304
XXL	30,00	2	075460305
XXXL	30,00	2	075460306

7548BL

t-shirt work in 100% cotone jersey 180 g, blu

CE



taglia	€	pacchetto	codice
XS	17,00	5	075480000
S	17,00	5	075480001
M	17,00	5	075480002
L	17,00	5	075480003
XL	17,00	5	075480004
XXL	17,00	5	075480005
XXXL	17,00	5	075480006

7546G

polo 3 bottoni
in cotone piqué 220 g, grigio

CE



taglia	€	pacchetto	codice
XS	30,00	2	075460100
S	30,00	2	075460101
M	30,00	2	075460102
L	30,00	2	075460103
XL	30,00	2	075460104
XXL	30,00	2	075460105
XXXL	30,00	2	075460106

7547BL

polo tecnica in CoolDry® 155 g, blu

CE



taglia	€	pacchetto	codice
XS	43,00	2	075470000
S	43,00	2	075470001
M	43,00	2	075470002
L	43,00	2	075470003
XL	43,00	2	075470004
XXL	43,00	2	075470005
XXXL	43,00	2	075470006

7548G

t-shirt work in 100% cotone jersey 180 g,
grigio

CE



taglia	€	pacchetto	codice
XS	17,00	5	075480100
S	17,00	5	075480101
M	17,00	5	075480102
L	17,00	5	075480103
XL	17,00	5	075480104
XXL	17,00	5	075480105
XXXL	17,00	5	075480106

7546N

polo 3 bottoni
in cotone piqué 220 g, nero

CE



taglia	€	pacchetto	codice
XS	30,00	2	075460200
S	30,00	2	075460201
M	30,00	2	075460202
L	30,00	2	075460203
XL	30,00	2	075460204
XXL	30,00	2	075460205
XXXL	30,00	2	075460206

7547G

polo tecnica in CoolDry® 155 g, grigio

CE



taglia	€	pacchetto	codice
XS	43,00	2	075470100
S	43,00	2	075470101
M	43,00	2	075470102
L	43,00	2	075470103
XL	43,00	2	075470104
XXL	43,00	2	075470105
XXXL	43,00	2	075470106

7548N

t-shirt work in 100% cotone jersey 180 g, nero

CE



taglia	€	pacchetto	codice
XS	17,00	5	075480200
S	17,00	5	075480201
M	17,00	5	075480202
L	17,00	5	075480203
XL	17,00	5	075480204
XXL	17,00	5	075480205
XXXL	17,00	5	075480206

75480

t-shirt work in 100% cotone jersey 180 g, arancio

CE



	€		
XS	17,00	5	075480300
S	17,00	5	075480301
M	17,00	5	075480302
L	17,00	5	075480303
XL	17,00	5	075480304
XXL	17,00	5	075480305
XXXL	17,00	5	075480306

7577N

gilet in 100% poliestere microfibra 50D imbottito e foderato, nero
Inserto elastico sul giromanica

CE



	€		
XS	41,00	1	075770000
S	41,00	1	075770001
M	41,00	1	075770002
L	41,00	1	075770003
XL	41,00	1	075770004
XXL	41,00	1	075770005
XXXL	41,00	1	075770006

7632G

pull in pile 280 g con inserti in poliestere, grigio antracite/nero

CE



	€		
XS	37,00	1	076320000
S	37,00	1	076320001
M	37,00	1	076320002
L	37,00	1	076320003
XL	37,00	1	076320004
XXL	37,00	1	076320005
XXXL	37,00	1	076320006

7555

gilet multitasche leggero in twill T/C 180 g, blu

CE



	€		
S	32,00	1	075550101
M	32,00	1	075550102
L	32,00	1	075550103
XL	32,00	1	075550104
XXL	32,00	1	075550105

7578G

gilet in nylon ripstop impermeabilizzato imbottito e foderato, grigio antracite.
Giromanica elasticizzata

CE



	€		
XS	56,00	1	075780000
S	56,00	1	075780001
M	56,00	1	075780002
L	56,00	1	075780003
XL	56,00	1	075780004
XXL	56,00	1	075780005
XXXL	56,00	1	075780006

7634N

micropile zip lunga 180 g, nero

CE



	€		
XS	32,00	1	076340000
S	32,00	1	076340001
M	32,00	1	076340002
L	32,00	1	076340003
XL	32,00	1	076340004
XXL	32,00	1	076340005
XXXL	32,00	1	076340006

7575A

gilet in ripstop impermeabilizzato 200 g imbottito e foderato, nero

CE



	€		
XS	50,00	1	075750200
S	50,00	1	075750201
M	50,00	1	075750202
L	50,00	1	075750203
XL	50,00	1	075750204
XXL	50,00	1	075750205
XXXL	50,00	1	075750206

7622G

giacca in pile 280 g con inserti in poliestere, grigio antracite/nero

CE



	€		
XS	41,00	1	076220000
S	41,00	1	076220001
M	41,00	1	076220002
L	41,00	1	076220003
XL	41,00	1	076220004
XXL	41,00	1	076220005
XXXL	41,00	1	076220006

7635N

micropile zip corta 180 g nero

CE



	€		
XS	25,00	1	076350500
S	25,00	1	076350501
M	25,00	1	076350502
L	25,00	1	076350503
XL	25,00	1	076350504
XXL	25,00	1	076350505
XXXL	25,00	1	076350506

7635G

micropile zip corta 180 g
grigio antracite

CE



	€	👤	📄
XS	25,00	1	076350510
S	25,00	1	076350511
M	25,00	1	076350512
L	25,00	1	076350513
XL	25,00	1	076350514
XXL	25,00	1	076350515
XXXL	25,00	1	076350516

7675N

giacca in softshell bilaminato elasticizzato 280 g,
foderata in pile, nero

CE



	€	👤	📄
XS	64,00	1	076750000
S	64,00	1	076750001
M	64,00	1	076750002
L	64,00	1	076750003
XL	64,00	1	076750004
XXL	64,00	1	076750005
XXXL	64,00	1	076750006

7780N

giaccone in 100% poliestere dooby 230T
impermeabilizzato, imbottito e foderato, nero
Cappuccio e maniche staccabili

CE



	€	👤	📄
XS	79,00	1	077800000
S	79,00	1	077800001
M	79,00	1	077800002
L	79,00	1	077800003
XL	79,00	1	077800004
XXL	79,00	1	077800005
XXXL	79,00	1	077800006

7641BL

felpa zip lunga con cappuccio
in 80% cotone, 20% poliestere 320 g, blu

CE



	€	👤	📄
XS	69,00	1	076410000
S	69,00	1	076410001
M	69,00	1	076410002
L	69,00	1	076410003
XL	69,00	1	076410004
XXL	69,00	1	076410005
XXXL	69,00	1	076410006

7682BL

giacca in softshell bilaminato elasticizzato 320 g
impermeabilizzata e foderata in pile, blu/nero
Cappuccio staccabile

CE



	€	👤	📄
S	79,00	1	076820001
M	79,00	1	076820002
L	79,00	1	076820003
XL	79,00	1	076820004
XXL	79,00	1	076820005
XXXL	79,00	1	076820006

7815N

pantaloni da lavoro multitasche
in T/C canvas ritorto 280 g
con inserti in poliestere, nero

CE

**7641G**

felpa zip lunga con cappuccio
in 80% cotone, 20% poliestere 320 g, grigio

CE



	€	👤	📄
XS	69,00	1	076410100
S	69,00	1	076410101
M	69,00	1	076410102
L	69,00	1	076410103
XL	69,00	1	076410104
XXL	69,00	1	076410105
XXXL	69,00	1	076410106

7681BL

giacca in softshell bilaminato elasticizzato 285 g,
foderata in pile, blu

CE



	€	👤	📄
S	86,50	1	076810001
M	86,50	1	076810002
L	86,50	1	076810003
XL	86,50	1	076810004
XXL	86,50	1	076810005
XXXL	86,50	1	076810006

	€	👤	📄
XS	69,00	1	078150000
S	69,00	1	078150001
M	69,00	1	078150002
L	69,00	1	078150003
XL	69,00	1	078150004
XXL	69,00	1	078150005
XXXL	69,00	1	078150006

7817N

gilet da lavoro multitasche in T/C canvas ritorto 280 g con inserti in mesh, nero

CE



Dimensione	€	Articolo	Quantità
XS	45,00	1 078170000	1
S	45,00	1 078170001	1
M	45,00	1 078170002	1
L	45,00	1 078170003	1
XL	45,00	1 078170004	1
XXL	45,00	1 078170005	1
XXXL	45,00	1 078170006	1

7820

pantaloni da lavoro in T/C canvas ritorto 280 g, inserti in Cordura® e Reflex 3M Scotchlite™, nero/grigio

CE



Dimensione	€	Articolo	Quantità
XS	73,00	1 078200000	1
S	73,00	1 078200001	1
M	73,00	1 078200002	1
L	73,00	1 078200003	1
XL	73,00	1 078200004	1
XXL	73,00	1 078200005	1
XXXL	73,00	1 078200006	1
XXXL	73,00	1 078200007	1

7821

bermuda da lavoro in T/C canvas ritorto 280 g, nero/grigio

CE



Dimensione	€	Articolo	Quantità
XS	54,00	1 078210000	1
S	54,00	1 078210001	1
M	54,00	1 078210002	1
L	54,00	1 078210003	1
XL	54,00	1 078210004	1
XXL	54,00	1 078210005	1
XXXL	54,00	1 078210006	1
XXXL	54,00	1 078210007	1

7823

salopette da lavoro in T/C canvas ritorto 280 g, inserti in Cordura® e Reflex 3M Scotchlite™, nero/grigio

CE



Dimensione	€	Articolo	Quantità
XS	88,00	1 078230000	1
S	88,00	1 078230001	1
M	88,00	1 078230002	1
L	88,00	1 078230003	1
XL	88,00	1 078230004	1
XXL	88,00	1 078230005	1
XXXL	88,00	1 078230006	1
XXXL	88,00	1 078230007	1

7825

tuta da lavoro in T/C canvas ritorto 280 g, inserti in Cordura® e Reflex 3M Scotchlite™, nero/grigio

CE



Dimensione	€	Articolo	Quantità
XS	113,00	1 078250000	1
S	113,00	1 078250001	1
M	113,00	1 078250002	1
L	113,00	1 078250003	1
XL	113,00	1 078250004	1
XXL	113,00	1 078250005	1
XXXL	113,00	1 078250006	1
XXXL	113,00	1 078250007	1

7827

gilet da lavoro in T/C canvas ritorto 280 g, inserti Reflex 3M Scotchlite™, nero/grigio

CE



Dimensione	€	Articolo	Quantità
XS	54,00	1 078270000	1
S	54,00	1 078270001	1
M	54,00	1 078270002	1
L	54,00	1 078270003	1
XL	54,00	1 078270004	1
XXL	54,00	1 078270005	1
XXXL	54,00	1 078270006	1
XXXL	54,00	1 078270007	1

7829

giacca da lavoro in T/C canvas ritorto 280 g, inserti in Cordura® e Reflex 3M Scotchlite™, nero/grigio

CE



	€		
XS	81,00	1	078290000
S	81,00	1	078290001
M	81,00	1	078290002
L	81,00	1	078290003
XL	81,00	1	078290004
XXL	81,00	1	078290005
XXXL	81,00	1	078290006
XXXXL	81,00	1	078290007

7860E

Pantaloni leggeri da lavoro in T/C twill 180 g con inserti in Oxford, grigio

CE



	€		
XS	39,50	1	078600900
S	39,50	1	078600901
M	39,50	1	078600902
L	39,50	1	078600903
XL	39,50	1	078600904
XXL	39,50	1	078600905
XXXL	39,50	1	078600906
XXXXL	39,50	1	078600907

7861E

bermuda leggeri da lavoro in T/C twill 180 g, grigio

CE



	€		
XS	32,50	1	078610900
S	32,50	1	078610901
M	32,50	1	078610902
L	32,50	1	078610903
XL	32,50	1	078610904
XXL	32,50	1	078610905
XXXL	32,50	1	078610906
XXXXL	32,50	1	078610907

7863E

salopette leggera da lavoro in T/C twill 180 g con inserti in Oxford, grigio

CE



	€		
XS	47,50	1	078630900
S	47,50	1	078630901
M	47,50	1	078630902
L	47,50	1	078630903
XL	47,50	1	078630904
XXL	47,50	1	078630905
XXXL	47,50	1	078630906
XXXXL	47,50	1	078630907

7865E

tuta leggera da lavoro in T/C twill 180 g con inserti in Oxford, grigio

CE



	€		
XS	61,00	1	078650900
S	61,00	1	078650901
M	61,00	1	078650902
L	61,00	1	078650903
XL	61,00	1	078650904
XXL	61,00	1	078650905
XXXL	61,00	1	078650906
XXXXL	61,00	1	078650907

7867E

gilet multitasche leggero da lavoro in T/C twill 180 g con inserti in Oxford, grigio

CE



	€		
XS	36,00	1	078670900
S	36,00	1	078670901
M	36,00	1	078670902
L	36,00	1	078670903
XL	36,00	1	078670904
XXL	36,00	1	078670905
XXXL	36,00	1	078670906
XXXXL	36,00	1	078670907

7869E

giacca leggera da lavoro in T/C twill 180 g
con inserti in Oxford, grigio

CE

Beta EASY

LIGHT



	€		
XS	42,00	1	078690900
S	42,00	1	078690901
M	42,00	1	078690902
L	42,00	1	078690903
XL	42,00	1	078690904
XXL	42,00	1	078690905
XXXL	42,00	1	078690906
XXXXL	42,00	1	078690907

7870

pantaloni da lavoro in T/C twill 180 g
con inserti in T/C Ripstop, blu

CE



	€		
XS	50,00	1	078700000
S	50,00	1	078700001
M	50,00	1	078700002
L	50,00	1	078700003
XL	50,00	1	078700004
XXL	50,00	1	078700005
XXXL	50,00	1	078700006

7871

bermuda da lavoro in T/C twill 180 g
con inserti in T/C Ripstop, blu

CE



	€		
XS	40,50	1	078710000
S	40,50	1	078710001
M	40,50	1	078710002
L	40,50	1	078710003
XL	40,50	1	078710004
XXL	40,50	1	078710005
XXXL	40,50	1	078710006

7873

salopette da lavoro in T/C twill 180 g,
inserti in T/C Ripstop, blu

CE



	€		
XS	60,00	1	078730000
S	60,00	1	078730001
M	60,00	1	078730002
L	60,00	1	078730003
XL	60,00	1	078730004
XXL	60,00	1	078730005
XXXL	60,00	1	078730006

7875

tuta leggera da lavoro in T/C twill 180 g
con inserti in T/C Ripstop, blu

CE



	€		
XS	86,50	1	078750000
S	86,50	1	078750001
M	86,50	1	078750002
L	86,50	1	078750003
XL	86,50	1	078750004
XXL	86,50	1	078750005
XXXL	86,50	1	078750006

7877

gilet da lavoro in T/C twill 180 g
con inserti in T/C Ripstop, blu

CE



	€		
XS	40,00	1	078770000
S	40,00	1	078770001
M	40,00	1	078770002
L	40,00	1	078770003
XL	40,00	1	078770004
XXL	40,00	1	078770005
XXXL	40,00	1	078770006

Beta

Beta

7879

giacca da lavoro in T/C twill 180 g
con inserti in T/C Ripstop, blu

CE



Dimensione	€	Articolo
XS	65,00	1 078790000
S	65,00	1 078790001
M	65,00	1 078790002
L	65,00	1 078790003
XL	65,00	1 078790004
XXL	65,00	1 078790005
XXXL	65,00	1 078790006

7900E

pantaloni da lavoro multitasche
in T/C canvas 260 g, inserti in Oxford, grigio

CE



Dimensione	€	Articolo
XS	42,50	1 079000900
S	42,50	1 079000901
M	42,50	1 079000902
L	42,50	1 079000903
XL	42,50	1 079000904
XXL	42,50	1 079000905
XXXL	42,50	1 079000906
XXXXL	42,50	1 079000907

**7901E**

bermuda da lavoro in T/C canvas 260 g, grigio

CE



Dimensione	€	Articolo
XS	34,50	1 079010900
S	34,50	1 079010901
M	34,50	1 079010902
L	34,50	1 079010903
XL	34,50	1 079010904
XXL	34,50	1 079010905
XXXL	34,50	1 079010906
XXXXL	34,50	1 079010907

7903E

salopette da lavoro in T/C canvas 260 g,
inserti in Oxford, grigio

CE



Dimensione	€	Articolo
XS	52,00	1 079030900
S	52,00	1 079030901
M	52,00	1 079030902
L	52,00	1 079030903
XL	52,00	1 079030904
XXL	52,00	1 079030905
XXXL	52,00	1 079030906
XXXXL	52,00	1 079030907

7904E

bomber da lavoro imbottito e foderato
in T/C canvas 260 g, inserti in "Oxford", grigio

CE



Dimensione	€	Articolo
XS	91,00	1 079040900
S	91,00	1 079040901
M	91,00	1 079040902
L	91,00	1 079040903
XL	91,00	1 079040904
XXL	91,00	1 079040905
XXXL	91,00	1 079040906
XXXXL	91,00	1 079040907

7905E

tuta da lavoro in T/C canvas 260 g,
inserti in Oxford, grigio

CE



Dimensione	€	Articolo
XS	65,50	1 079050900
S	65,50	1 079050901
M	65,50	1 079050902
L	65,50	1 079050903
XL	65,50	1 079050904
XXL	65,50	1 079050905
XXXL	65,50	1 079050906
XXXXL	65,50	1 079050907



7907E

gilet multitasche da lavoro in T/C canvas 260 g, inserti in Oxford, grigio

CE

Beta EASY



Taglie	€	Art.	Art.
XS	39,00	1	079070900
S	39,00	1	079070901
M	39,00	1	079070902
L	39,00	1	079070903
XL	39,00	1	079070904
XXL	39,00	1	079070905
XXXL	39,00	1	079070906
XXXXL	39,00	1	079070907

7909E

giacca da lavoro in T/C canvas 260 g, inserti in Oxford, grigio

CE

Beta EASY



Taglie	€	Art.	Art.
XS	46,00	1	079090900
S	46,00	1	079090901
M	46,00	1	079090902
L	46,00	1	079090903
XL	46,00	1	079090904
XXL	46,00	1	079090905
XXXL	46,00	1	079090906
XXXXL	46,00	1	079090907

Beta

7910Y

pantaloni da lavoro in twill di cotone prelavato elasticizzato 240 g, marrone fango

CE



Taglie	€	Art.	Art.
XS	81,00	1	079100100
S	81,00	1	079100101
M	81,00	1	079100102
L	81,00	1	079100103
XL	81,00	1	079100104
XXL	81,00	1	079100105
XXXL	81,00	1	079100106

7911Y

bermuda da lavoro in twill di cotone elasticizzato prelavato 240 g, marrone fango

CE



Taglie	€	Art.	Art.
XS	60,00	1	079110100
S	60,00	1	079110101
M	60,00	1	079110102
L	60,00	1	079110103
XL	60,00	1	079110104
XXL	60,00	1	079110105
XXXL	60,00	1	079110106

7913Y

salopette da lavoro in twill di cotone elasticizzato prelavato 240 g, marrone fango

CE



Taglie	€	Art.	Art.
XS	94,00	1	079130100
S	94,00	1	079130101
M	94,00	1	079130102
L	94,00	1	079130103
XL	94,00	1	079130104
XXL	94,00	1	079130105
XXXL	94,00	1	079130106

7930P

pantaloni da lavoro in 100% cotone 260 g, grigio payne

CE



Taglie	€	Art.	Art.
XS	50,00	1	079300100
S	50,00	1	079300101
M	50,00	1	079300102
L	50,00	1	079300103
XL	50,00	1	079300104
XXL	50,00	1	079300105
XXXL	50,00	1	079300106

Beta

7933P

salopette da lavoro in 100% cotone 260 g, grigio payne

CE



taglia	€	1	079330100
XS	60,00	1	079330100
S	60,00	1	079330101
M	60,00	1	079330102
L	60,00	1	079330103
XL	60,00	1	079330104
XXL	60,00	1	079330105
XXXL	60,00	1	079330106

7935P

tuta da lavoro in 100% cotone 260 g, grigio payne

CE



taglia	€	1	079350100
XS	78,50	1	079350100
S	78,50	1	079350101
M	78,50	1	079350102
L	78,50	1	079350103
XL	78,50	1	079350104
XXL	78,50	1	079350105
XXXL	78,50	1	079350106

7937P

gilet da lavoro in 100% cotone 260 g, grigio payne

CE



taglia	€	1	079370100
XS	39,50	1	079370100
S	39,50	1	079370101
M	39,50	1	079370102
L	39,50	1	079370103
XL	39,50	1	079370104
XXL	39,50	1	079370105
XXXL	39,50	1	079370106

7939P

giacca da lavoro in 100% cotone 260 g, grigio payne

CE



taglia	€	1	079390100
XS	60,00	1	079390100
S	60,00	1	079390101
M	60,00	1	079390102
L	60,00	1	079390103
XL	60,00	1	079390104
XXL	60,00	1	079390105
XXXL	60,00	1	079390106

7930IP

pantaloni da lavoro in 100% cotone 260 g, foderati in flanella di cotone 115 g, grigio payne

CE



taglia	€	1	079300200
XS	80,00	1	079300200
S	80,00	1	079300201
M	80,00	1	079300202
L	80,00	1	079300203
XL	80,00	1	079300204
XXL	80,00	1	079300205
XXXL	80,00	1	079300206

7931P

bermuda da lavoro in 100% cotone 260 g, grigio payne

CE



taglia	€	1	079310100
XS	37,50	1	079310100
S	37,50	1	079310101
M	37,50	1	079310102
L	37,50	1	079310103
XL	37,50	1	079310104
XXL	37,50	1	079310105
XXXL	37,50	1	079310106

7930D

pantaloni da lavoro in 100% cotone 260 g, grigio davy

CE



	€		
XS	50,00	1	079300000
S	50,00	1	079300001
M	50,00	1	079300002
L	50,00	1	079300003
XL	50,00	1	079300004
XXL	50,00	1	079300005
XXXL	50,00	1	079300006

7931D

bermuda da lavoro in 100% cotone 260 g, grigio davy

CE



	€		
XS	37,50	1	079310000
S	37,50	1	079310001
M	37,50	1	079310002
L	37,50	1	079310003
XL	37,50	1	079310004
XXL	37,50	1	079310005
XXXL	37,50	1	079310006

7933D

salopette da lavoro in 100% cotone 260 g, grigio davy

CE



	€		
XS	60,00	1	079330000
S	60,00	1	079330001
M	60,00	1	079330002
L	60,00	1	079330003
XL	60,00	1	079330004
XXL	60,00	1	079330005
XXXL	60,00	1	079330006

7935D

tuta da lavoro in 100% cotone 260 g, grigio davy

CE



	€		
XS	78,50	1	079350000
S	78,50	1	079350001
M	78,50	1	079350002
L	78,50	1	079350003
XL	78,50	1	079350004
XXL	78,50	1	079350005
XXXL	78,50	1	079350006

7937D

gilet da lavoro in 100% cotone 260 g, grigio davy

CE



	€		
XS	39,50	1	079370000
S	39,50	1	079370001
M	39,50	1	079370002
L	39,50	1	079370003
XL	39,50	1	079370004
XXL	39,50	1	079370005
XXXL	39,50	1	079370006

7939D

giacca da lavoro in 100% cotone 260 g, grigio davy

CE



	€		
XS	60,00	1	079390000
S	60,00	1	079390001
M	60,00	1	079390002
L	60,00	1	079390003
XL	60,00	1	079390004
XXL	60,00	1	079390005
XXXL	60,00	1	079390006

7970

pantaloni impermeabili in PVC Tricot,
blu

CE



	€		
XS	30,00	1	079700000
S	30,00	1	079700001
M	30,00	1	079700002
L	30,00	1	079700003
XL	30,00	1	079700004
XXL	30,00	1	079700005
XXXL	30,00	1	079700006

7973

salopette impermeabile in PVC Tricot,
blu

CE



	€		
XS	37,00	1	079730000
S	37,00	1	079730001
M	37,00	1	079730002
L	37,00	1	079730003
XL	37,00	1	079730004
XXL	37,00	1	079730005
XXXL	37,00	1	079730006

7979

giacca impermeabile in PVC Tricot,
blu

CE



	€		
S	50,00	1	079790001
M	50,00	1	079790002
L	50,00	1	079790003
XL	50,00	1	079790004
XXL	50,00	1	079790005
XXXL	50,00	1	079790006

7971E

pantaloni impermeabili in poliestere spalmato PVC
con cuciture termonastrate, blu

CE



	€		
XS	13,50	1	079710000
S	13,50	1	079710001
M	13,50	1	079710002
L	13,50	1	079710003
XL	13,50	1	079710004
XXL	13,50	1	079710005
XXXL	13,50	1	079710006

**7978E**

giacca impermeabile in poliestere spalmato PVC
con cuciture termonastrate, blu

CE



	€		
XS	19,00	1	079780000
S	19,00	1	079780001
M	19,00	1	079780002
L	19,00	1	079780003
XL	19,00	1	079780004
XXL	19,00	1	079780005
XXXL	19,00	1	079780006

7991N

calzamaglia intima tecnica
in 100% poliestere 130 g, nero

CE



	€		
S	14,00	1	079910001
M	14,00	1	079910002
L	14,00	1	079910003
XL	14,00	1	079910004
XXL	14,00	1	079910005

7992N

maglia intima tecnica maniche lunghe
in 100% poliestere 130 g, nero

CE



	€		
S	18,00	1	079920001
M	18,00	1	079920002
L	18,00	1	079920003
XL	18,00	1	079920004
XXL	18,00	1	079920005

7993

calzamaglia intima tecnica
in 74% poliammide, 24% poliestere, 2%
spandex, nero
Realizzata con tecnologia "seamless" che
svolge un'azione contenitiva e favorisce i
movimenti

CE



	€		
S	27,00	1	079930001
M/L	27,00	1	079930002
XL/XXL	27,00	1	079930004

7994

maglia intima tecnica maniche lunghe
in 75% nylon, 25% poliestere, nero/grigio
Realizzata con tecnologia "seamless" che

CE



	€		
S	38,00	1	079940001
M/L	38,00	1	079940002
XL/XXL	38,00	1	079940004

7995

maglia intima tecnica maniche corte
in 75% nylon, 25% poliestere, nero/grigio
Realizzata con tecnologia "seamless" che svolge
un'azione contenitiva e favorisce i movimenti

CE



	€		
S	33,00	1	079950001
M/L	33,00	1	079950002
XL/XXL	33,00	1	079950004

7984

cintura da lavoro in 90% poliestere, 10%
cotone
taglia unica 130 cm accorciabile, larghezza
35 mm
grigio antracite



7984	11,00	1	079840130
------	-------	---	-----------

7800G

coppia ginocchiere da lavoro



7800G	8,50	1	078000500
-------	------	---	-----------

7980

cappello anti-pioggia tascabile
in PU nylon, nero

CE



	€		
M	14,00	5	079800002
L	14,00	5	079800003
XL	14,00	5	079800004

7981

berretto in lana e Thinsulate™ 150 g,
nero

CE



	€		
M	19,00	5	079810002
XL	19,00	5	079810004

7982G

cappellino in T/C canvas 270 g, grigio

CE



7982	10,00	5	079820009
------	-------	---	-----------

7982B

cappellino in T/C canvas 280 g, nero

CE



7982N	10,00	5	079820109
-------	-------	---	-----------



7061TC

occhiali di protezione con lenti in policarbonato trasparente

CE

EASY



7061TC € 6,50 1 070610001

7071BC

occhiali di protezione con lenti in policarbonato trasparente

CE

AIR



EN166F - 1F

7071BC € 11,00 1 070710009

7071BD

occhiali di protezione con lenti in policarbonato

CE

AIR



EN166 - 1F

7071BD € 11,00 1 070710019

7076BC

occhiali di protezione con lenti in policarbonato trasparente

CE

SPORT

EN166F-1F
EN170
UV 5-3.1

7076BC € 14,00 1 070760009

7076BD

occhiali di protezione con lenti in policarbonato trasparente

CE

SPORT

EN166F-1F
EN170
UV 5-2.5

7076BD € 14,00 1 070760019

7076BP

occhiali di protezione con lenti in policarbonato polarizzato

CE

SPORT



EN1836-2005

7076BP € 24,00 1 070760029

7091BC

occhiali di protezione con lenti in policarbonato semitrasparente

CE

DRIVE

EN166F - 1F
EN170
EN172
UV 5-3.1

7091BC € 21,00 1 070910002

7091BD

occhiali di protezione con lenti in policarbonato scuro

CE

DRIVE

EN166F - 1F
EN170
EN172
UV 5-2.5

7091BD € 21,00 1 070910012

7093BC

occhiali di protezione con lenti in policarbonato trasparente

CE

IMPACT

EN166F-1F
EN170
UV400

7093BC € 22,50 1 070930009

7093BD

occhiali di protezione con lenti in policarbonato scuro

CE

IMPACT

EN166F-1F
EN172
UV5-2.5

7093BD € 22,50 1 070930019

7051MP

maschera di protezione con visiera in policarbonato

CE



EN166

7051MP € 6,50 5 070510001

7190C

cuffie antirumore in PVC

- attenuazione da 15,5 dB a 63 Hz sino a 37 dB a 8000 Hz

CE



EN 352-1

7190C € 8,50 2 071900002

7195A

mascherine antipolvere FFP1



7195A € 3,90 071950004

C62M/W

espositore a manichino

185
cm

65 cm

C62M/W € 330,00 1 062000360

C62EV/CP

espositore per calzature, 15 posizioni



C62EV/CP € 155,00 1 062000401

C62E/B

espositore per abbigliamento

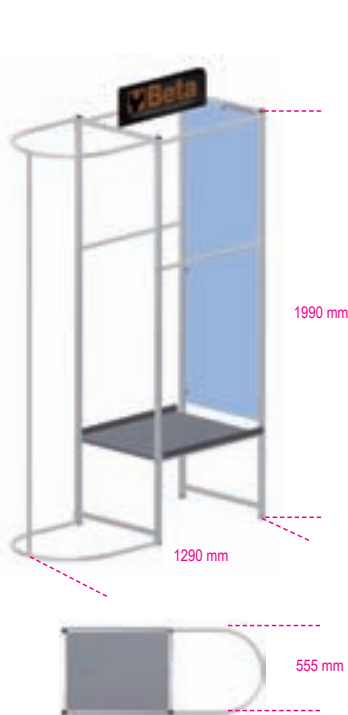

C62E/B € 640,00 1 062000550

C62E/B2

espositore per abbigliamento confezionato

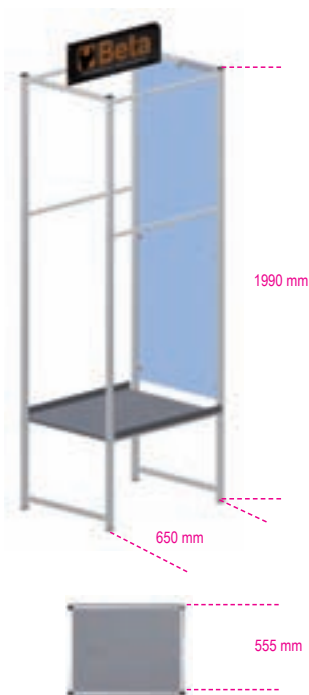

C62E/B2 € 490,00 1 062000552

C62E/D

espositore per abbigliamento con camerino

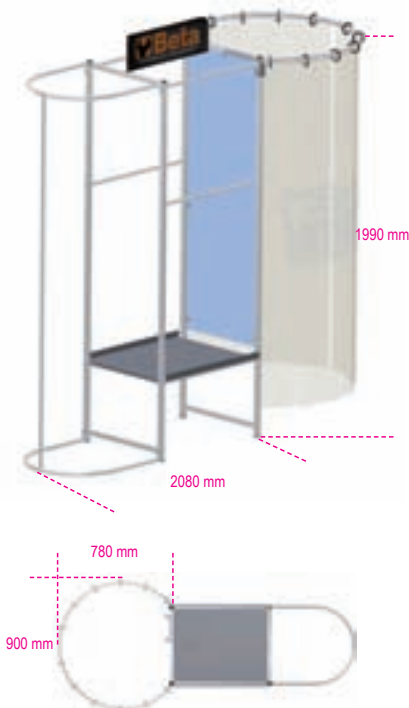

C62E/D € 850,00 1 062000600

C62

espositore per abbigliamento con predisposizione per calzature



		€		
C62/1	1 m	780,00	1	062000001
C62/2	2 m	1.380,00	1	062000002
C62/3	3 m	1.980,00	1	062000003
C62/4	4 m	2.580,00	1	062000004

ACCESSORI C62

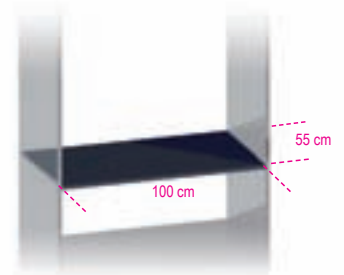

C62/R € 110,00 1 062000050

6200AP/S10

set da 10 grucce



6200AP/S10 € 30,00 1 062000331

Robur



Dal 1930, Robur produce linee di accessori per funi allineandosi alla riconosciuta qualità di Beta Utensili, di cui è complemento produttivo.

Esperienza, organizzazione e tecnologia sono i requisiti di un continuo sviluppo determinato dall'attenzione alle esigenze del mercato.

Dal 1984, Robur ha sede in un moderno stabilimento a Sulmona.

CARICHI

WLL: carico massimo di esercizio
(per accessori di sollevamento)

WFL: forza limite di lavoro
(per accessori non destinati al sollevamento)

BF: forza massima raggiunta dall'articolo durante la prova di trazione statica

LC: tensione di ancoraggio

Guida alla lettura

8240F

numero articolo

golfari maschi FORGIATI
acciaio inox A4

CE



DIN 580:2010

misura	Ø mm	WLL kg	€	numero codice
* M10	1,5	400		1 082400410
* M12	1,75	600	8,65	1 082400412
* M14	2	1000	14,00	1 082400414
* M16	2	1200	22,70	1 082400416
* M20	2,5	2000	22,70	1 082400420
* M24	3	2700	36,50	1 082400424
* M30	3,5	3200	68,00	1 082400430

(*) WLL incrementato rispetto a norma DIN
in base a Fascicolo Tecnico R/FT/8240F
(garantito per accoppiamenti inox-inox)

4 diverse tipologie di certificazione

140 specifiche tecniche costantemente aggiornate

Articolo	Rapporto di Prova 2.2 (UNI EN 10204)	Certificato di Controllo 3.1 (UNI EN 10204)	Certificato del fabbricante	Dichiarazione di Conformità CE
8001Z	✓	✓		✓
8002ZD	✓			
8003ZD	✓			
8004ND	✓			
8005Z	✓			✓
8006Z	✓			✓
8007Z	✓			✓
8008N	✓			✓
8009FD	✓			
8009Z	✓			✓
8010Z	✓			✓
8016	✓			✓
8016DA	✓			✓
8016DF	✓			✓
8016FR	✓			
8016U	✓		✓	✓
8018E	✓			
8018T	✓			
8020	✓			
8021	✓			
8025	✓	✓		✓
8026A	✓	✓		✓
8028	✓	✓		✓
8029	✓	✓		✓
8029R	✓	✓		✓
8030	✓	✓		✓
8031	✓	✓		✓
8040EN	✓	✓		✓
8040EZ	✓	✓		✓
8042EN	✓	✓		✓
8042EZ	✓	✓		✓
8044	✓	✓		✓
8048	✓			
8049	✓	✓		✓
8051S	✓	✓		✓
8055S	✓	✓		✓
8057	✓	✓		✓
8058	✓	✓		✓
8060	✓	✓		✓
8061F	✓	✓		✓
8062	✓	✓		✓
8064S	✓	✓		✓
8065SC	✓	✓		✓
8074	✓			
8080	✓			

Articolo	Rapporto di Prova 2.2 (UNI EN 10204)	Certificato di Controllo 3.1 (UNI EN 10204)	Certificato del fabbricante	Dichiarazione di Conformità CE
8085	✓	✓		✓
8086	✓	✓		✓
8090	✓	✓		✓
8090F	✓	✓		✓
8091			✓	✓
8092			✓	✓
8094			✓	✓
8096			✓	✓
8097			✓	✓
8098			✓	✓
8100	✓	✓		✓
8105	✓			
8109	✓			
8114	✓			
8116	✓			
8150	✓		✓	✓
8153	✓		✓	✓
8156	✓		✓	✓
8157	✓		✓	✓
8158	✓		✓	✓
8159	✓		✓	✓
8160	✓		✓	✓
8161	✓		✓	✓
8166	✓			
8170	✓		✓	✓
8173	✓		✓	✓
8176	✓		✓	✓
8177	✓		✓	✓
8178	✓		✓	✓
8180	✓			
8181	✓			
8182	✓			
8182S	✓			
8185	✓			
8186	✓			
8187	✓			
8188C	✓			
8188CG/25	✓			
8188F	✓			
8188F/35	✓			
8188FG2	✓			
8188FG3	✓			
8302Z	✓			
8303Z	✓			

Articolo	Rapporto di Prova 2.2 (UNI EN 10204)	Certificato di Controllo 3.1 (UNI EN 10204)	Certificato del fabbricante	Dichiarazione di Conformità CE
8317DZ	✓			
8317SZ	✓			
8381SL	✓			
8381SP	✓			
8383C	✓			
8383P	✓			
8515V	✓			
8515Z	✓			
8531	✓			
8532	✓			
8535	✓			
8205	✓			
8206	✓			
8207	✓			
8209	✓			
8210	✓			
8216	✓			✓
8220	✓			
8225	✓			
8227	✓			
8228	✓			
8240	✓			
8240F	✓	✓		✓
8242	✓			
8242F	✓	✓		✓
8249	✓			
8250	✓			
8264	✓			
8267	✓			
8272	✓			
8273	✓			
8274	✓			
8274G	✓			
8276	✓			
8276G	✓			
8278	✓			
8280	✓			
8282	✓			
8284	✓			
8285	✓			
8286	✓			
8287	✓			
8290	✓			
8381SX	✓			

8001Z

canaile per tenditori
zincate



Ø mm	Ø "	L mm	WFL kg	€		
M5	3/16	80	115	0,95	1	080010105
M6	1/4	80	160	1,10	1	080010106
M8	5/16	105	300	1,55	1	080010108
M10	3/8	125	470	1,85	1	080010110
M11	7/16	135	580	2,35	1	080010111
M12	1/2	140	690	2,55	1	080010112
M14	9/16	170	940	3,70	1	080010114
M16	5/8	190	1290	5,05	1	080010116
M18	11/16	205	1660	7,70	1	080010118
M20	3/4	220	2130	8,80	1	080010120
M22	7/8	240	2630	11,60	1	080010122
M24	1"	260	3060	13,70	1	080010124
M27	1 1/8	270	4000	22,50	1	080010127
M30	1 3/16	280	4860	28,00	1	080010130
M33	1 1/4	290	6040	29,50	1	080010133
M36*	1 3/8	300	6500	39,00	1	080010198
M39*	1 1/2	300	7900	47,50	1	080010199

* filettatura Whitworth

8001TZ

canaile a tubo per tenditori
zincate



DIN 1478

Ø mm	Ø "	L mm	WFL kg	€		
M12	1/2	125	690	4,00	1	080010512
M16	5/8	170	1290	6,50	1	080010516
M20	3/4	200	2130	9,00	1	080010520
M24	1"	255	3060	16,00	1	080010524
M30	1.3/16	255	4860	26,00	1	080010530

8002ZD

anelli per tenditori,
filettatura destra, zincati

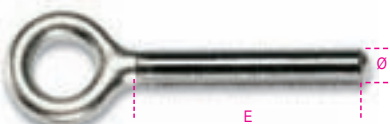

Ø mm	Ø "	E mm	WFL kg	€		
M5	3/16	37	115	0,35	200	080020105
M6	1/4	40	160	0,40	150	080020106
M8	5/16	52	300	0,60	100	080020108
M10	3/8	60	470	0,90	100	080020110
M11	7/16	65	580	1,20	1	080020111
M12	1/2	72	690	1,50	50	080020112
M14	9/16	85	940	1,90	1	080020114
M16	5/8	95	1290	3,30	1	080020116
M18	11/16	103	1660	4,60	1	080020118
M20	3/4	110	2130	5,10	1	080020120
M22	7/8	120	2630	7,50	1	080020122
M24	1"	130	3060	9,80	1	080020124
M27	1 1/8	135	4000	14,20	1	080020127
M30	1 3/16	140	4860	16,40	1	080020130
M33	1 1/4	148	6040	20,00	1	080020133
M36*	1 3/8	150	6500	24,70	1	080020198
M39*	1 1/2	150	7900	28,50	1	080020199

* filettatura Whitworth

filetto sinistrorso

Ø mm	Ø "	E mm	WFL kg	€		
M5	3/16	37	115	0,35	1	080020305
M6	1/4	40	160	0,40	1	080020306
M8	5/16	52	300	0,60	1	080020308
M10	3/8	60	470	0,90	1	080020310

Ø mm	Ø "	E mm	WFL kg	€		
M11	7/16	65	580	1,20	1	080020311
M12	1/2	72	690	1,50	1	080020312
M14	9/16	85	940	1,90	1	080020314
M16	5/8	95	1290	3,30	1	080020316
M18	11/16	103	1660	4,60	1	080020318
M20	3/4	110	2130	5,10	1	080020320
M22	7/8	120	2630	7,50	1	080020322
M24	1"	130	3060	9,80	1	080020324
M27	1 1/8	135	4000	14,20	1	080020327
M30	1 3/16	140	4860	16,40	1	080020330
M33	1 1/4	148	6040	20,00	1	080020333
M36*	1 3/8	150	6500	24,70	1	080020398
M39*	1 1/2	150	7900	28,50	1	080020399

* filettatura Whitworth

8004ND

tronchi per tenditori
destri - neri

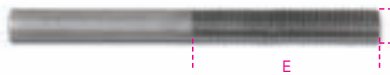

Ø mm	Ø "	E mm	WFL kg	€		
M5	3/16	40	115	0,40	1	080040005
M6	1/4	44	160	0,45	1	080040006
M8	5/16	53	300	0,55	1	080040008
M10	3/8	63	470	0,70	1	080040010
M11	7/16	68	580	1,10	1	080040011
M12	1/2	70	690	1,25	1	080040012
M14	9/16	85	940	1,50	1	080040014
M16	5/8	95	1290	2,00	1	080040016
M18	11/16	103	1660	2,70	1	080040018
M20	3/4	110	2130	3,50	1	080040020
M22	7/8	120	2630	4,30	1	080040022
M24	1"	130	3060	6,00	1	080040024
M27	1 1/8	135	4000	9,70	1	080040027
M30	1 3/16	140	4860	12,30	1	080040030
M33	1 1/4	150	6040	12,60	1	080040033
M36*	1 3/8	150	6500	16,50	1	080040098
M39*	1 1/2	150	7900	18,00	1	080040099

* filettatura Whitworth

filetto sinistrorso

Ø mm	Ø "	E mm	WFL kg	€		
M5	3/16	40	115	0,40	1	080040105
M6	1/4	44	160	0,45	1	080040106
M8	5/16	53	300	0,55	1	080040108
M10	3/8	63	470	0,70	1	080040110
M11	7/16	68	580	1,10	1	080040111
M12	1/2	70	690	1,25	1	080040112
M14	9/16	85	940	1,50	1	080040114
M16	5/8	95	1290	2,00	1	080040116
M18	11/16	103	1660	2,70	1	080040118
M20	3/4	110	2130	3,50	1	080040120
M22	7/8	120	2630	4,30	1	080040122
M24	1"	130	3060	6,00	1	080040124
M27	1 1/8	135	4000	9,70	1	080040127
M30	1 3/16	140	4860	12,30	1	080040130
M33	1 1/4	150	6040	12,60	1	080040133
M36*	1 3/8	150	6500	16,50	1	080040198
M39*	1 1/2	150	7900	18,00	1	080040199

* filettatura Whitworth

8003ZD

ganci per tenditori,
filettatura destra, zincati



Ø mm	Ø "	E mm	WFL kg	€		
M5	3/16	40	25	0,50	150	080030105
M6	1/4	40	45	0,55	120	080030106
M8	5/16	52	95	0,75	100	080030108
M10	3/8	60	140	1,20	70	080030110
M11	7/16	65	165	1,60	1	080030111
M12	1/2	70	300	2,00	30	080030112
M14	9/16	85	420	3,10	1	080030114
M16	5/8	95	570	4,80	1	080030116
M18	11/16	103	700	6,35	1	080030118
M20	3/4	110	900	8,70	1	080030120
M22	7/8	120	1100	11,20	1	080030122
M24	1"	130	1300	17,90	1	080030124
M27	1 1/8	135	2300	21,60	1	080030127

filetto sinistrorso

Ø mm	Ø "	WFL kg	E mm	€		
M5	3/16	40	25	0,50	1	080030305
M6	1/4	40	45	0,55	1	080030306
M8	5/16	52	95	0,75	1	080030308
M10	3/8	60	140	1,20	1	080030310
M11	7/16	65	165	1,60	1	080030311
M12	1/2	70	300	2,00	1	080030312
M14	9/16	85	420	3,10	1	080030314
M16	5/8	95	570	4,80	1	080030316
M18	11/16	103	700	6,35	1	080030318
M20	3/4	110	900	8,70	1	080030320
M22	7/8	120	1100	11,20	1	080030322
M24	1"	130	1300	17,90	1	080030324
M27	1 1/8	135	2300	21,60	1	080030327

8009FD

forcelle per tenditori
destra - zincate

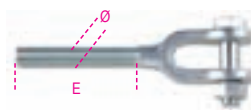

Ø mm	Ø "	E mm	WFL kg	€		
M8	5/16	53	300	4,30	1	080090208
M10	3/8	63	470	4,95	1	080090210
M12	1/2	70	690	6,40	1	080090212
M14	9/16	85	940	8,50	1	080090214
M16	5/8	95	1290	9,45	1	080090216
M18	11/16	103	1660	12,90	1	080090218
M20	3/4	110	2130	13,20	1	080090220
M22	7/8	120	2630	17,80	1	080090222
M24	1"	130	3060	23,60	1	080090224
M27	1 1/8	135	4000	39,50	1	080090227
M30	1 3/16	140	4860	50,00	1	080090230

filetto sinistrorso

Ø mm	Ø "	E mm	WFL kg	€		
M8	5/16	53	300	4,30	1	080090408
M10	3/8	63	470	4,95	1	080090410
M12	1/2	70	690	6,40	1	080090412
M14	9/16	85	940	8,50	1	080090414
M16	5/8	95	1290	9,45	1	080090416
M18	11/16	103	1660	12,90	1	080090418
M20	3/4	110	2130	13,20	1	080090420
M22	7/8	120	2630	17,80	1	080090422
M24	1"	130	3060	23,60	1	080090424
M27	1 1/8	135	4000	39,50	1	080090427
M30	1 3/16	140	4860	50,00	1	080090430

Robur

8005Z

tenditori a due occhi
zincati

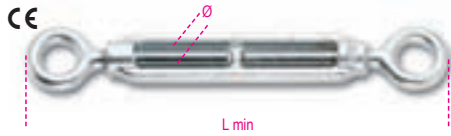

Ø mm	Ø "	L min mm	WFL kg	€	📦	🚚
M5	3/16	118	115	1,60	400	080050105
M6	1/4	130	160	1,90	300	080050106
M8	5/16	158	300	2,70	200	080050108
M10	3/8	192	470	3,80	100	080050110
M11	7/16	206	580	5,00	80	080050111
M12	1/2	226	690	5,60	60	080050112
M14	9/16	256	940	7,90	15	080050114
M16	5/8	290	1290	12,00	1	080050116
M18	11/16	358	1660	18,30	1	080050118
M20	3/4	358	2130	19,80	1	080050120
M22	7/8	400	2630	27,00	1	080050122
M24	1"	436	3060	33,50	1	080050124
M27	1 1/8	474	4000	51,50	1	080050125
M30	1 3/16	498	4860	61,50	1	080050130
M33	1 1/4	516	6040	67,00	1	080050126
M36*	1 3/8	532	6500	89,00	1	080050136
M39*	1 1/2	544	7900	103,00	1	080050139

* filettatura Whitworth

confezioni speciali

Ø mm	Ø "	📦	€	📦	🚚
M5	3/16	30	48,00	1	080050705
M6	1/4	30	57,00	1	080050706
M8	5/16	20	54,00	1	080050708
M10	3/8	15	57,00	1	080050710
M11	7/16	15	75,00	1	080050711
M12	1/2	15	84,00	1	080050712

8005TZ

tenditori a due occhi, canaule a tubo
zincati



DIN 1478

Ø mm	Ø "	WFL kg	€	📦	🚚
M12	1/2	690	9,00	1	080050512
M16	5/8	1290	13,00	1	080050516
M20	3/4	2130	20,00	1	080050520
M24	1"	3060	36,00	1	080050524
M30	1.3/16	4860	60,00	1	080050530

8006Z

tenditori ad occhio e gancio
zincati

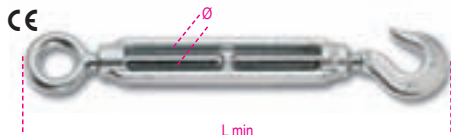

Ø mm	Ø "	L min mm	WFL kg	€	📦	🚚
M5	3/16	121	25	1,80	400	080060105
M6	1/4	132	45	2,00	250	080060106
M8	5/16	170	95	2,80	180	080060108
M10	3/8	204	140	4,00	100	080060110
M11	7/16	221	165	5,20	70	080060111
M12	1/2	244	300	6,20	15	080060112
M14	9/16	284	420	8,90	1	080060114
M16	5/8	322	570	13,20	1	080060116
M18	11/16	373	700	19,50	1	080060118
M20	3/4	391	900	23,00	1	080060120
M22	7/8	433	1100	30,50	1	080060122
M24	1"	470	1300	41,50	1	080060124
M27	1 1/8	503	2300	57,00	1	080060127

confezioni speciali

Ø mm	"	📦	€	📦	🚚
M5	3/16	30	54,00	1	080060705
M6	1/4	30	60,00	1	080060706
M8	5/16	20	56,00	1	080060708
M10	3/8	15	60,00	1	080060710
M11	7/16	15	78,00	1	080060711

8007Z

tenditori a due ganci
zincati

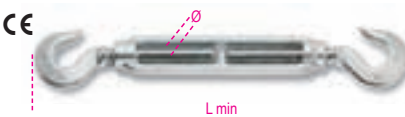

Ø mm	Ø "	L min mm	WFL kg	€	📦	🚚
M5	3/16	124	25	2,00	30	080070105
M6	1/4	134	45	2,20	30	080070106
M8	5/16	181	95	2,90	20	080070108
M10	3/8	211	140	4,30	15	080070110
M11	7/16	231	165	5,60	15	080070111
M12	1/2	262	300	6,60	15	080070112
M14	9/16	312	420	9,80	1	080070114
M16	5/8	354	570	14,30	1	080070116
M18	11/16	388	700	20,00	1	080070118
M20	3/4	424	900	26,00	1	080070120
M22	7/8	466	1100	33,50	1	080070122
M24	1"	504	1300	48,00	1	080070124
M27	1 1/8	532	2300	63,50	1	080070127

8008N

tenditori a due tronchi
neri

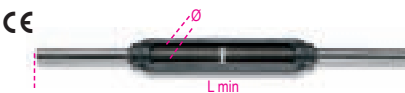

Ø mm	Ø "	L min mm	WFL kg	€	📦	🚚
M5	3/16	160	115	1,70	1	080080205
M6	1/4	180	160	1,80	1	080080206
M8	5/16	210	300	2,50	1	080080208
M10	3/8	250	470	3,20	1	080080210
M11	7/16	270	580	3,60	1	080080211
M12	1/2	280	690	4,40	1	080080212
M14	9/16	340	940	6,30	1	080080214
M16	5/8	380	1290	8,50	1	080080216
M18	11/16	410	1660	12,70	1	080080218
M20	3/4	440	2130	14,80	1	080080220
M22	7/8	480	2630	20,00	1	080080222
M24	1"	520	3060	23,50	1	080080224
M27	1 1/8	560	4000	39,00	1	080080227
M30	1 3/16	560	4860	48,00	1	080080230
M33	1 1/4	600	6040	49,00	1	080080233
M36*	1 3/8	600	6500	62,50	1	080080236
M39*	1 1/2	600	7900	74,50	1	080080239

* filettatura Whitworth

8009Z

tenditori a due forcelle
zincati

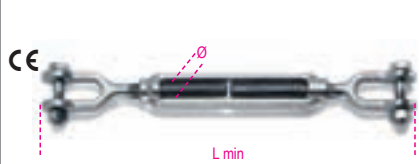

Ø mm	Ø "	L min mm	WFL kg	€	📦	🚚
M8	5/16	192	300	10,10	1	080090008
M10	3/8	234	470	11,60	1	080090010
M12	1/2	274	690	15,50	1	080090012
M14	9/16	342	940	21,20	1	080090014
M16	5/8	372	1290	24,50	1	080090016
M18	11/16	406	1660	34,00	1	080090018
M20	3/4	406	2130	36,50	1	080090020
M22	7/8	466	2630	51,50	1	080090022
M24	1"	486	3060	59,50	1	080090024
M27	1 1/8	510	4000	99,00	1	080090027
M30	1 3/16	566	4860	123,50	1	080090030

8010Z

tenditori ad occhio e forcella
zincati

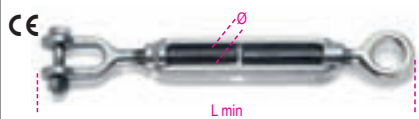

Ø mm	Ø "	L min mm	WFL kg	€	📦	🚚
M8	5/16	175	300	6,20	1	080100008
M10	3/8	215	470	7,60	1	080100010
M12	1/2	250	690	10,10	1	080100012
M14	9/16	299	940	13,80	1	080100014
M16	5/8	331	1290	17,30	1	080100016
M18	11/16	382	1660	26,00	1	080100018
M20	3/4	382	2130	29,00	1	080100020
M22	7/8	433	2630	39,50	1	080100022
M24	1"	461	3060	46,50	1	080100024
M27	1 1/8	492	4000	74,00	1	080100027
M30	1 3/16	529	4860	94,50	1	080100030

8105

tenditori a due occhi ad alta resistenza
zincati a caldo

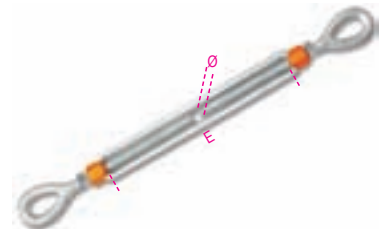

ØxL "	≈ mm	WFL kg	€	📦	🚚
3/8x6	M10x150	540	8,20	1	081050010
1/2x9	M12x230	1000	17,30	1	081050012
5/8x9	M16x230	1590	26,00	1	081050016
3/4x9	M20x230	2360	39,50	1	081050020
7/8x12	M22x300	3270	66,00	1	081050022
1"x6	M24x150	4540	69,00	1	081050024
1"x12	M24x300	4540	98,00	1	081050025
1 1/4x12	M33x300	6890	166,00	1	081050031

Altre misure disponibili a richiesta



8109

tenditori a due forcelle ad alta resistenza zincati a caldo

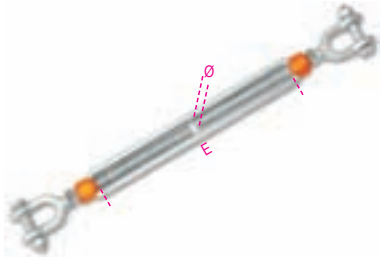

ØxL " mm	WFL kg	€	📦	🚚
3/8x6 M10x150	540	10,90	1	081090010
1/2x9 M12x230	1000	21,70	1	081090012
5/8x9 M16x230	1590	39,00	1	081090016
3/4x9 M20x230	2360	53,00	1	081090020
7/8x12 M22x300	3270	86,00	1	081090022
1"x6 M24x150	4540	87,00	1	081090024
1"x12 M24x300	4540	121,50	1	081090025
1"x1/4x12 M33x300	6890	198,00	1	081090031

Altre misure disponibili a richiesta

8016U

morsetti EN 13411-5, tipo A corpo in ghisa malleabile zincati

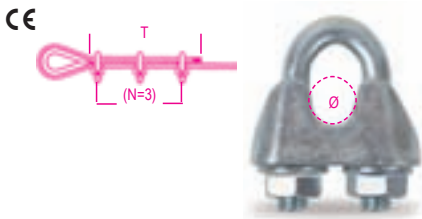

EN 13411-5

Ø mm	Ø "	N x T	Nm	€	📦	🚚
5	3/16	3x156	2,0	0,40	300	080160605
6,5	1/4	3x192	3,5	0,65	150	080160606
8	5/16	4x320	6	1,20	70	080160608
10	3/8	4x320	9	1,35	60	080160610
12	1/2	4x384	20	2,45	25	080160612
14	9/16	4x448	33	3,15	15	080160614
16	5/8	4x512	49	4,55	10	080160616
19	3/4	4x512	68	5,10	15	080160619
22	7/8	5x680	107	6,85	10	080160622
26	1"	5x760	147	11,50	15	080160626
30	1 1/8	6x984	212	14,60	5	080160630
34	1 1/4	6x1080	296	19,80	5	080160634
40	1 1/2	6x1176	363	24,80	3	080160640

8016

morsetti in acciaio zincati

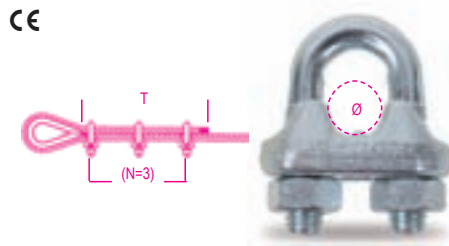

Ø mm	Ø "	N x T	Nm	€	📦	🚚
3	1/8	3x80	1,25	0,40	500	080160003
5	3/16	3x110	2,46	0,55	300	080160005
6	1/4	3x120	4,24	0,60	200	080160006
8	5/16	5x210	4,24	0,75	150	080160008
10	3/8	5x240	10,20	1,05	70	080160010
11	7/16	5x260	10,20	1,20	70	080160011
12-13	1/2	5x300	20,11	1,60	40	080160013
14	9/16	5x295	20,11	1,75	35	080160014
16	5/8	5x335	20,11	2,05	30	080160016
18	11/16	5x380	34,43	2,80	30	080160018
20	3/4	5x540	34,43	3,00	30	080160020
22	7/8	7x595	34,43	3,45	25	080160022
24-26	1"	7x700	54,77	4,80	15	080160026
28	1 1/16	8x840	54,77	5,60	1	080160028
30-32	1 1/8	8x990	54,77	6,00	1	080160030
34-36	1 1/4	8x1155	85,14	8,00	1	080160034
38-40	1 1/2	8x1320	85,14	10,50	1	080160040

confezioni speciali

Ø mm	"	📦	€	🚚
3	1/8	100	40,00	1 080160703
5	3/16	50	27,50	1 080160705
6	1/4	50	30,00	1 080160706
8	5/16	30	22,50	1 080160708
10	3/8	30	31,50	1 080160710
11	7/16	25	30,00	1 080160711
12-13	1/2	15	24,00	1 080160713

8016DA

morsetti in acciaio, dado alto zincati

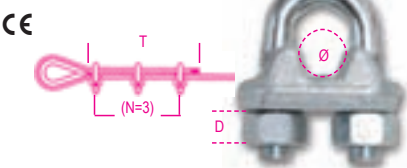

Ø mm	N x T	Nm	D mm	€	📦	🚚
5	3x110	2,46	5	0,70	300	080160093
6	3x120	4,24	6	0,75	200	080160092
8	5x210	4,24	6	0,90	150	080160098
10	5x240	10,20	8	1,25	70	080160096

8016DF

morsetti in acciaio, dado flangiato zincati

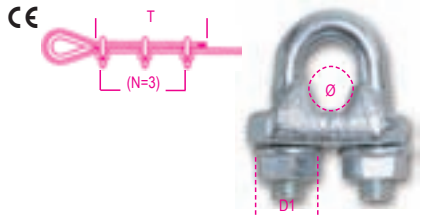

Ø mm	N x T	Nm	D1 mm	€	📦	🚚
6	3x120	4,24	14,2	0,70	200	080160066
8	5x210	4,24	14,2	0,85	150	080160068
10	5x240	10,20	17,9	1,30	70	080160070

8016FR

morsetti in acciaio, corpo stampato a freddo zincati

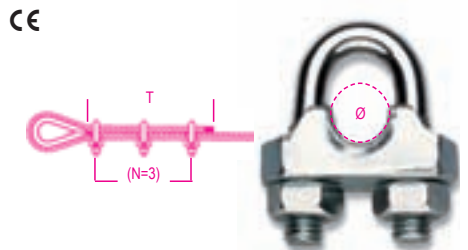

Ø mm	Ø "	N x T	Nm	€	📦	🚚
3	1/8	3x80	1,25	0,40	500	080160253
5	3/16	3x110	2,46	0,50	300	080160255
6	1/4	3x120	4,24	0,60	200	080160256
8	5/16	5x210	4,24	0,70	150	080160258
10	3/8	5x240	10,20	1,00	70	080160260
12-13	1/2	5x300	20,11	1,40	40	080160263

8018E

morsetti tipo ENEL corpo in acciaio zincato a caldo



Ø mm	A mm	L mm	Nm	€	📦	🚚
4÷6	M6	34	4,24	0,75	100	080180001

8018T

morsetti tipo TELECOM, corpo in ghisa malleabile zincato a caldo



Ø mm	A mm	L mm	Nm	€	📦	🚚
8÷10	M8	42	10,20	0,80	200	080180003

8317DZ

morsetti duplex
zincati



Ø mm	L mm	L1 mm	€	📦	🚚
2	30	14	0,20	50	083170002
3	35	15	0,25	50	083170003
4	40	18	0,30	50	083170004
5	50	21	0,45	25	083170005
6	60	25	0,60	20	083170006
8	76	33	1,10	10	083170008
10	95	37	1,75	10	083170010

8317SZ

morsetti simplex
zincati

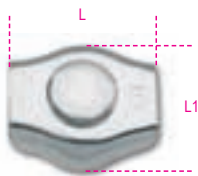

Ø mm	L mm	L1 mm	€	📦	🚚
2	15	14	0,15	100	083170102
3	18	16	0,15	100	083170103
4	20	19	0,20	100	083170104
5	24	23	0,25	50	083170105
6	30	27	0,30	30	083170106
8	36	34	0,60	20	083170108
10	42	37	0,90	10	083170110

8020

radance tipo leggero
zincate

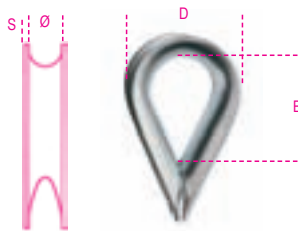

Ø mm	S mm	B mm	D mm	€	📦	🚚
2-3	0,6	16	16	0,16	350	080200003
4	0,7	19	18	0,16	300	080200004
5	0,8	24	22	0,17	300	080200005
6	1,0	28	26	0,19	200	080200006
8	1,2	33	30	0,30	180	080200008
10	1,5	38	34	0,44	120	080200010
12	1,8	44	46	0,50	160	080200012
14	2,0	49	50	0,59	100	080200014
16	2,0	57	59	0,83	150	080200016
18	2,5	68	69	1,19	100	080200018
20	3,0	78	77	1,83	70	080200020
22	3,0	88	84	1,99	60	080200022
25	3,5	92	91	2,70	40	080200025
28	4,0	109	115	4,90	10	080200028

confezioni speciali

Ø mm	S mm	📦	€	🚚
2-3	0,6	150	24,00	1 080200703
4	0,7	150	24,00	1 080200704
5	0,8	100	17,00	1 080200705
6	1,0	100	19,00	1 080200706
8	1,2	50	15,00	1 080200708
10	1,5	30	13,20	1 080200710

8021

radance tipo pesante
zincate

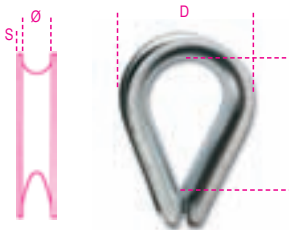

Ø mm	S mm	B mm	D mm	€	📦	🚚
5	1,7	29	28	0,35	120	080210005
6	1,8	33	30	0,40	100	080210006
8	2,5	36	37	0,50	100	080210008
10	2,5	42	43	0,70	80	080210010
12	2,5	48	50	0,85	100	080210012
14	2,7	58	57	1,10	70	080210014
16	3,0	61	62	1,40	50	080210016
18	3,5	71	71	1,85	70	080210018
20	4,0	79	79	2,65	60	080210020
22	4,0	87	84	2,80	50	080210022
24	4,0	93	92	3,80	40	080210024
26	4,0	103	103	4,90	35	080210026
28	5,0	107	116	10,50	1	080210028
30	5,0	118	121	11,70	1	080210030
32	5,5	138	135	13,50	1	080210032
35	6,0	140	147	20,00	1	080210035
40	6,0	173	170	26,00	1	080210040

8025

grilli diritti tipo largo
zincati

CE



Ø mm	B x C mm	WLL kg	€	📦	🚚
5	3/16 21x10	70	1,10	250	080250005
6	1/4 25x12	100	1,40	250	080250006
8	5/16 33x16	250	2,10	150	080250008
10	3/8 42x20	400	2,40	180	080250010
11	7/16 46x22	500	2,90	130	080250011
12	1/2 50x24	600	3,20	100	080250012
14	9/16 57x28	800	4,20	70	080250014
16	5/8 61x32	1000	5,50	15	080250016
18	11/16 65x36	1300	7,80	15	080250018
20	3/4 70x40	1600	9,20	10	080250020
22	7/8 74x44	2000	13,00	10	080250022
25	1" 80x48	2800	16,30	5	080250025

confezioni speciali

Ø mm	📦	€	🚚
5	3/16 25	27,50	1 080250705
6	1/4 25	35,00	1 080250706
8	5/16 25	52,50	1 080250708
10	3/8 15	36,00	1 080250710
11	7/16 12	35,00	1 080250711
12	1/2 12	38,50	1 080250712
14	9/16 10	42,00	1 080250714

8026A

grilli diritti
(ex UNI 1947 tipo A)
zincati

CE

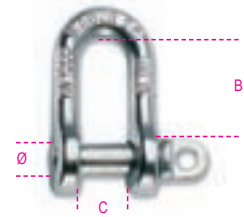

Ø mm	Ø "	B x C mm	WLL kg	€	📦	🚚
12	1/2	42x20	630	3,20	35	080260012
14	9/16	46x22	800	4,10	30	080260014
16	5/8	50x24	1000	5,20	20	080260016
18	11/16	54x26	1300	7,30	15	080260018
20	3/4	58x28	1600	8,50	10	080260020
22	7/8	69x32	2000	12,70	10	080260022
25	1"	79x36	2500	17,00	5	080260025
28	1.1/8	90x40	3150	22,60	1	080260028
32	1.1/4	100x45	4000	31,50	1	080260032
36	1.3/8	110x50	5000	46,50	1	080260036
40	1.9/16	120x55	6300	64,50	1	080260040
42	1.5/8	131x60	8000	86,00	1	080260042
45	1.3/4	143x65	10000	110,00	1	080260045
50	2"	155x70	12500	141,50	1	080260050

8531

grilli tipo pesca
zincati a caldo

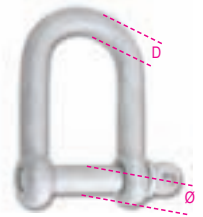

Ø mm	D mm	WFL kg	€	📦	🚚
20	18	1600	11,70	1	085310018
22	20	2500	16,90	1	085310020

8532

grilli tipo pesca con perno quadro,
verniciati neri



Ø mm	D mm	WFL kg	€	📦	🚚
20	20	1600	6,00	1	085320020
22	22	2500	9,00	1	085320022



8028

grilli a lira
zincati

CE

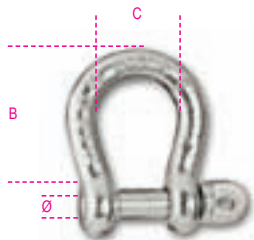

Ø mm	B x C mm	WLL kg	€		
5	3/16 20x16	80	0,95	1	080280105
6	1/4 24x20	100	1,30	1	080280106
8	5/16 32x24	200	2,10	1	080280108
10	3/8 40x33	300	2,50	1	080280110
11	7/16 44x36	400	3,10	1	080280111
12	1/2 48x39	500	3,90	1	080280112
14	9/16 56x46	600	5,60	1	080280114
16	5/8 64x46	800	6,90	1	080280116
18	11/16 71x59	950	10,70	1	080280118
20	3/4 80x65	1100	11,70	1	080280120
22	7/8 88x72	1500	17,50	1	080280122
25	1" 100x81	2000	27,50	1	080280125
28	1.1/8 112x91	2600	42,50	1	080280128
32	1.1/4 128x104	3200	58,50	1	080280132
38	1.1/2 152x124	4500	115,00	1	080280138

8029R

grilli a lira
acciaio legato, GRADO 6
staffa zincata a caldo

CE

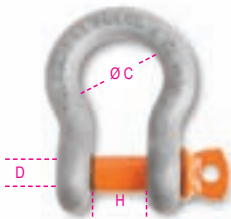

EN 13889

ØD mm (")	ØC mm	H mm	WLL kg	€	
8 (5/16)	20	12	500	2,40	1 080290106
10 (3/8)	22	13	750	2,70	1 080290108
11 (7/16)	26	17	1000	3,60	1 080290110
13 (1/2)	29	18	1500	5,20	1 080290111
16 (5/8)	33	21	2000	5,90	1 080290112
19 (3/4)	43	27	3250	10,00	1 080290116
22 (7/8)	51	31	4750	13,80	1 080290120
25 (1")	58	35	6500	21,00	1 080290122
28 (1.1/8)	68	43	8500	29,50	1 080290124
32 (1.1/4)	75	48	9500	44,50	1 080290128
35 (1.3/8)	84	53	12000	59,50	1 080290132
38 (1.1/2)	94	59	13500	79,00	1 080290135
42 (1.5/8)	99	62	17000	103,00	1 080290138
50 (2")	128	75	25000	176,00	1 080290145

8029

grilli a lira
acciaio legato, GRADO 6
staffa zincata a caldo

CE



EN 13889

Ø mm	WLL kg	€	
11	1000	8,40	1 080290011
13	1500	10,20	1 080290013
16	2000	15,00	1 080290016

*Misure non contemplate nella norma

Ø mm	WLL kg	€	
19	3250	20,00	1 080290019
22	4750	26,00	1 080290022
25	6500	36,00	1 080290025
28	8500	50,00	1 080290028
32	9500	76,00	1 080290032
35	12000	96,00	1 080290035
38	13500	115,00	1 080290038
42	17000	178,00	1 080290042
50	25000	295,00	1 080290050
* 57	35000	380,00	1 080290057
* 65	42500	610,00	1 080290065
* 70	55000	735,00	1 080290070

*Misure non contemplate nella norma

8030

grilli a lira con perno a foro quadro,
acciaio legato, GRADO 6
staffa zincata a caldo

CE



Ø mm	WLL kg	€	
16	2000	17,80	1 080300016
19	3250	21,80	1 080300019
22	4750	27,50	1 080300022
25	6500	41,50	1 080300025

8031

grilli a lira con dado e copiglia,
acciaio legato, GRADO 6
staffa zincata a caldo

CE



EN 13889

Ø mm	WLL kg	€	
11	1000	12,20	1 080310011
16	2000	15,40	1 080310016
19	3250	24,00	1 080310019
22	4750	31,50	1 080310022
25	6500	43,50	1 080310025
28	8500	61,00	1 080310028
32	9500	82,00	1 080310032
35	12000	120,00	1 080310035
38	13500	150,00	1 080310038
42	17000	210,00	1 080310042
50	25000	320,00	1 080310050
* 70	55000	820,00	1 080310070

*Misure non contemplate nella norma

DIN 580 / 582 : 2010				
	WLL I	WLL II	WLL III	WLL IV
	kg	kg	kg	kg
*M6	90	90	90	90
M8	140	140	140	95
M10	230	230	230	160
M12	340	340	340	240
*M14	480	480	480	335
M16	700	700	700	495
*M18	930	930	930	655
M20	1200	1200	1200	845
*M22	1450	1450	1450	1025
M24	1800	1800	1800	1270
*M27	2400	2400	2400	1695
M30	3200	3200	3200	2260
*M33	3900	3900	3900	2755
M36	4600	4600	4600	3250
M42	6300	6300	6300	4455
M48	8600	8600	8600	6060
M56	11500	11500	11500	8130
M64	16000	16000	16000	11310

*misure non contemplate nella norma

8040EZ

golfari maschi DIN 580
zincati

CE

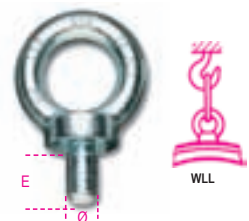

DIN 580

Ø mm	E mm	WLL kg	€	
* M6	1 11	90	1,45	60 080400406
M8	1,25 13	140	1,45	60 080400408
M10	1,5 17	230	1,85	50 080400410
M12	1,75 20,5	340	2,40	25 080400412
* M14	2 20,5	480	3,05	25 080400414
M16	2 27	700	3,60	1 080400416
* M18	2,5 27	930	4,70	1 080400418
M20	2,5 30	1200	5,50	1 080400420
* M22	2,5 30	1450	7,40	1 080400422
M24	3 36	1800	10,50	1 080400424
* M27	3 41	2400	13,30	1 080400427
M30	3,5 45	3200	20,50	1 080400430
* M33	3,5 54	3900	29,50	1 080400433
* M33F	2 54	3900	29,50	1 080400434
M36	4 54	4600	31,00	1 080400436
* M36F	3 54	4600	31,00	1 080400437
M42	4,5 63	6300	61,00	1 080400442
* M42F	3 63	6300	61,00	1 080400443
M48	5 68	8600	99,00	1 080400448
* M48F	3 68	8600	99,00	1 080400449
M56	5,5 78	11500	145,00	1 080400456
* M56F	4 78	11500	145,00	1 080400457
M64	6 90	16000	205,00	1 080400464
* M64F	4 90	16000	205,00	1 080400465

*Misure non contemplate nella norma

8040EN

golfari maschi DIN 580
neri

CE



DIN 580

Ø mm	E mm	WLL kg	€	
* M6	1 11	90	1,40	60 080400306
M8	1,25 13	140	1,40	60 080400308
M10	1,5 17	230	1,80	50 080400310
M12	1,75 20,5	340	2,30	25 080400312

*Misure non contemplate nella norma

Robur

Ø mm	mm	E mm	WLL kg	€		
* M14	2	20,5	480	2,90	25	080400314
M16	2	27	700	3,40	1	080400316
* M18	2,5	27	930	4,50	1	080400318
M20	2,5	30	1200	5,20	1	080400320
* M22	2,5	30	1450	7,00	1	080400322
M24	3	36	1800	9,80	1	080400324
* M27	3	41	2400	13,00	1	080400327
M30	3,5	45	3200	20,00	1	080400330
* M33	3,5	54	3900	28,00	1	080400333
* M33F	2	54	3900	28,00	1	080400334
M36	4	54	4600	29,50	1	080400336
* M36F	3	54	4600	29,50	1	080400337
M42	4,5	63	6300	57,00	1	080400342
* M42F	3	63	6300	57,00	1	080400343
M48	5	68	8600	94,00	1	080400348
* M48F	3	68	8600	94,00	1	080400349
M56	5,5	78	11500	137,00	1	080400356
* M56F	4	78	11500	137,00	1	080400357
M64	6	90	16000	190,00	1	080400364
* M64F	4	90	16000	190,00	1	080400365

*Misure non contemplate nella norma

8042EZ

golfari femmina DIN 582
zincati

CE

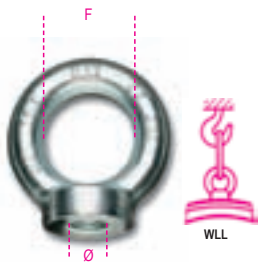

DIN 582

Ø mm	mm	F mm	WLL kg	€		
* M6	1	14	90	1,45	60	080420406
M8	1,25	20	140	1,45	60	080420408
M10	1,5	25	230	1,85	50	080420410
M12	1,75	30	340	2,40	30	080420412
* M14	2	30	480	3,00	30	080420414
M16	2	35	700	3,50	1	080420416
* M18	2,5	35	930	4,60	1	080420418
M20	2,5	40	1200	5,40	1	080420420
* M22	2,5	40	1450	7,20	1	080420422
M24	3	50	1800	10,30	1	080420424
* M27	3	55	2400	13,00	1	080420427
M30	3,5	60	3200	19,70	1	080420430
M36	4	70	4600	31,00	1	080420436
* M36F	3	70	4600	31,00	1	080420437
M42	4,5	80	6300	60,00	1	080420442
* M42F	3	80	6300	60,00	1	080420443
M48	5	90	8600	98,00	1	080420448
* M48F	3	90	8600	98,00	1	080420449

*Misure non contemplate nella norma

8042EN

golfari femmina DIN 582
neri

CE



DIN 582

Ø mm	mm	F mm	WLL kg	€		
* M6	1	14	90	1,40	60	080420306
M8	1,25	20	140	1,40	60	080420308
M10	1,5	25	230	1,80	50	080420310
M12	1,75	30	340	2,30	30	080420312
* M14	2	30	480	2,80	30	080420314
M16	2	35	700	3,30	1	080420316
* M18	2,5	35	930	4,35	1	080420318

*Misure non contemplate nella norma

Ø mm	mm	F mm	WLL kg	€		
M20	2,5	40	1200	5,05	1	080420320
* M22	2,5	40	1450	6,80	1	080420322
M24	3	50	1800	9,60	1	080420324
* M27	3	55	2400	12,70	1	080420327
M30	3,5	60	3200	19,20	1	080420330
M36	4	70	4600	29,00	1	080420336
* M36F	3	70	4600	29,00	1	080420337
M42	4,5	80	6300	56,00	1	080420342
* M42F	3	80	6300	56,00	1	080420343
M48	5	90	8600	92,00	1	080420348
* M48F	3	90	8600	92,00	1	080420349

*Misure non contemplate nella norma

8044

golfari femmina UNI
neri

CE



UNI 2948

Ø mm	mm	WLL kg	€		
M8	1,25	80	3,40	1	080440008
M10	1,5	160	4,20	1	080440010
M12	1,75	250	7,00	1	080440012
M14	2	250	8,30	1	080440014
M16	2	400	8,70	1	080440016
M20	2,5	630	15,90	1	080440020
M24	3	1000	30,00	1	080440024
M30	3,5	1600	49,00	1	080440030

8049

golfari maschi orientabili
a doppia articolazione,
acciaio legato ad alta resistenza

CE

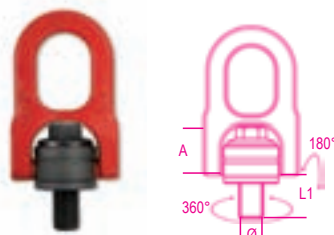

Ø mm	A mm	L1 mm	WLL kg	€		
M8	31,5	14	300	84,00	1	080490008
M10	31,5	17	600	87,00	1	080490010
M12	31,5	21	1000	90,00	1	080490012
M16	45	27	1600	100,00	1	080490016
M20	45	30	2500	103,00	1	080490020
M24	60,5	36	4000	175,00	1	080490024
M30	60,5	45	6300	182,00	1	080490030

WLL (t)								
	A°	M8	M10	M12	M16	M20	M24	M30
	0°	0,3	0,6	1	1,6	2,5	4	6,3
	90°	0,6	1,2	2	3,2	5	8	12,6
	180°	0,3	0,6	1	1,6	2,5	4	6,3
	270°	0,6	1,2	2	3,2	5	8	12,6
	45°	0,4	0,8	1,4	2,2	3,5	5,6	8,8
	135°	0,3	0,6	1	1,6	2,5	4	6,3
	225°	0,6	1,3	2,1	3,4	5,3	8,4	13,2
	315°	0,3	0,6	1	1,6	2,3	4	6,3

8048

tiranti ad occhio
destri
neri



UNI 6058

ØxL mm	F mm	€		
M8x50	6	2,70	1	080480108
M8x65	6	2,85	1	080480109
M10x80	8	4,00	1	080480110
M10x100	8	4,30	1	080480210
M10x130	8	4,95	1	080480111
M12x95	10	4,00	1	080480112
M12x125	10	5,70	1	080480113
M14x110	12	6,40	1	080480114
M16x130	14	5,10	1	080480116
M18x150	16	12,00	1	080480118
M20x160	18	14,50	1	080480120
M22x180	18	20,50	1	080480122
M24x200	20	26,00	1	080480124
M27x220	22	34,00	1	080480127

8074

moschettoni DIN 5299
zincati

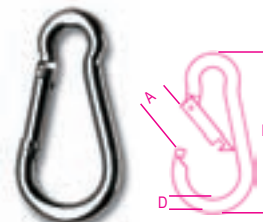

DIN 5299

DxL mm	A mm	WFL kg	€		
4x40	6	20	0,35	100	080740040
5x50	7	30	0,40	100	080740050
6x60	8	40	0,45	100	080740060
7x70	9	60	0,55	50	080740070
8x80	11	75	0,70	50	080740080
9x90	12	100	0,95	25	080740090
10x100	13	120	1,20	25	080740100
11x120	16	140	1,70	20	080740101
12x140	22	140	2,30	15	080740102
13x160	24	200	3,20	10	080740103

8080

maglie rapide di giunzione
zincate

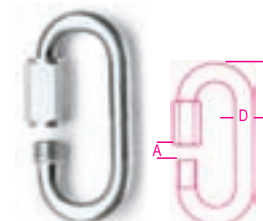

DxL mm	A mm	WFL kg	€		
3,5x36	5	20	0,35	100	080800003
4x40	6	30	0,35	100	080800004
5x49	6	50	0,40	100	080800005
6x57	8	60	0,50	100	080800006
7x66	8	100	0,75	50	080800007
8x74	11	140	0,90	50	080800008
9x80	11	160	1,20	25	080800009
10x89	11	220	1,35	25	080800010
12x105	15	300	2,30	20	080800012

8114

tornichetti tipo Marche
zincati

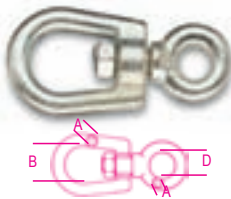

A mm	B mm	D mm	WFL kg	€		
8	30	16	250	2,80	1	081140008
10	38	18	300	5,00	1	081140010
12	42	20	650	7,30	1	081140012
14	48	22	820	11,00	1	081140014
16	57	24	1000	15,00	1	081140016
18	64	26	1600	18,00	1	081140018
20	72	30	2000	26,00	1	081140020
22	80	34	2500	36,00	1	081140022

8116

tornichetti tipo Sicilia
zincati

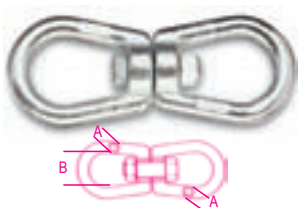

A mm	B mm	WFL kg	€		
6	23	140	3,10	1	081160006
8	30	250	3,90	1	081160008
10	38	300	6,80	1	081160010
12	42	650	10,50	1	081160012
14	48	820	15,50	1	081160014
16	57	1000	19,50	1	081160016
18	64	1600	24,50	1	081160018
20	72	2000	34,00	1	081160020
22	80	2500	56,00	1	081160022

8300

golfari per ponteggi
completi di barretta e tassello
zincati



A x of mm	E mm	L mm	WFL kg	€		
M12x18	50	220	850	8,50	20	083000012

8345

tasselli di ricambio per golfari da ponteggio



8345T12	€		
8300 M12 ø18	1,40	20	083450025

8302Z

viti ad occhio per tasselli
filettatura destra
zincate



Ø mm	E mm	F mm	WFL kg	€		
M5	48	8	115	0,35	200	083020005
M6	55	10	160	0,45	150	083020006
M8	60	12	300	0,60	100	083020008
M10	73	14	470	0,95	100	083020010
M12	90	17	690	1,80	50	083020012

8303Z

ganci per tasselli
filettatura destra
zincati

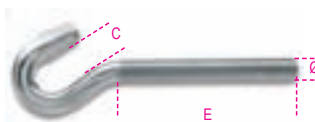

Ø mm	C mm	E mm	WFL kg	€		
M5	6,0	48	25	0,45	150	083030005
M6	8,0	55	45	0,55	120	083030006
M8	10,0	60	95	0,70	100	083030008
M10	12,5	73	140	1,25	70	083030010
M12	16,0	90	220	2,30	30	083030012

8381SL

collari per sostegno tubazioni
serie leggera
zincati



D mm	D gas	E mm	€		
11	1/8"	M6	0,35	100	083810201
14	1/4"	M6	0,40	100	083810202
18	3/8"	M6	0,40	100	083810203
22	1/2"	M6	0,45	100	083810204
27	3/4"	M6	0,45	100	083810205
34	1"	M6	0,50	100	083810206
43	1 1/4"	M6	0,50	100	083810207
49	1 1/2"	M8	0,85	50	083810208
61	2"	M8	0,90	50	083810209
77	2 1/2"	M8	1,05	25	083810210
89	3"	M8	1,20	25	083810211
102	3 1/2"	M8	1,35	25	083810212
115	4"	M8	1,50	25	083810213

8381SP

collari per sostegno tubazioni
serie pesante
zincati

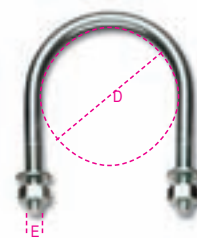

D mm	D gas	E mm	€		
22	1/2"	M8	0,70	100	083810301
27	3/4"	M8	0,75	100	083810302
34	1"	M8	0,80	100	083810303
43	1 1/4"	M8	0,85	100	083810304
49	1 1/2"	M10	1,40	50	083810305
61	2"	M10	1,50	50	083810306
77	2 1/2"	M10	1,65	50	083810307
89	3"	M10	1,85	25	083810308
102	3 1/2"	M12	2,70	25	083810309
115	4"	M12	3,00	25	083810310

8383C

collari quadri per agricoltura
zincati a caldo

Dadi flangiati

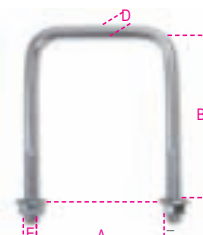

A mm	E mm	B mm	D mm	€		
70	M10	110	8,55	1,30	130	083830070
80	M10	120	8,55	1,50	110	083830080
90	M10	130	8,55	1,65	100	083830090
100	M10	155	8,55	1,90	90	083830100
120	M10	175	8,55	2,20	70	083830120

8383P

piastre per collari quadri
zincate a caldo

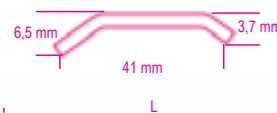

	L mm	€		
8383P/150	150	1,65	150	083830214
8383C/70-80				
/90-100				
8383P/170	170	1,95	120	083830217
8383C/100-120				

Robur

8515Z

tirafili per agricoltura
zincati

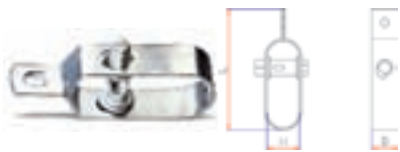

D mm	H mm	L mm	€		
20	25	93	0,85	100	085150002
24,5	30	100	1,10	70	085150003

8515V

tirafili per agricoltura
zincati e verniciati

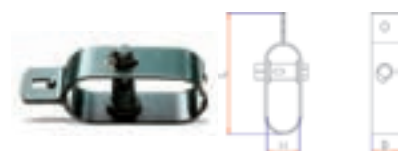

D mm	H mm	L mm	€		
20	25	93	1,05	100	085150102
24,5	30	100	1,30	70	085150103

8535

uncini tipo pesca
zincati

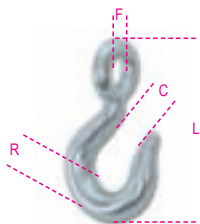

R mm	C mm	F mm	L mm	€		
26	27,5	34	156	12,50	1	085350006
30	36,5	40	185	18,40	1	085350007

8051S

ganci di sollevamento con sicura
acciaio al carbonio
zincati

CE



WLL kg	C mm	F mm	€		
250	14	12	1,90	1	080510202
500	18	16,5	4,10	1	080510205

8055S

ganci di sollevamento tipo americano,
acciaio legato ad alta resistenza

CE



EN 1677-2
GRADO 8

WLL kg	C mm	F mm	€		
1250	20	19	10,30	1	080550110
1600	22	25	12,00	1	080550115
2500	23	28	16,50	1	080550120
3200	27	32	20,00	1	080550130
5400	32	40	35,00	1	080550145
8000	41	51	81,50	1	080550170
11500	53	64	158,00	1	080550215
16000	58	70	215,00	1	080550260
22000	78	90	480,00	1	080550320

8057

ganci self-locking ad occhio,
acciaio legato ad alta resistenza

CE



EN 1677-3
GRADO 8

WLL kg	C mm	F mm	Ø mm	€		
2000	33	25	7-8	58,00	1	080570020
3150	44	32	10	87,00	1	080570032
5300	54	40	13	140,00	1	080570053

8058

ganci self-locking Clevis,
acciaio legato ad alta resistenza

CE



EN 1677-3
GRADO 8

WLL kg	C mm	F mm	Ø mm	€		
2000	33	10	7-8	66,00	1	080580020
3150	44	13	10	99,00	1	080580032
5300	54	16	13	148,00	1	080580053

8060

ganci Clevis per catena,
acciaio legato ad alta resistenza

CE

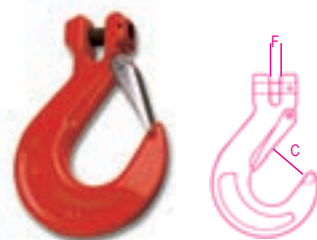

EN 1677-2
GRADO 8

WLL kg	C mm	F mm	Ø mm	€		
1120	20	7,5	6	23,50	1	080600011
2000	25	9,5	7-8	27,00	1	080600020
3150	33	12,0	10	39,50	1	080600032
5300	43	15,5	13	65,00	1	080600053
8000	48	19	16	107,00	1	080600080

8061F

ganci accorciatori a forcella
con sicura di bloccaggio,
acciaio legato ad alta resistenza

CE

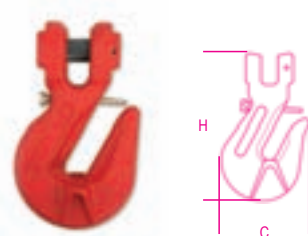

EN 1677-1
GRADO 8

WLL kg	C mm	H mm	Ø mm	€		
1120	41	72	6	19,50	1	080610111
2000	54	96	7-8	21,50	1	080610120
3150	75	124	10	30,50	1	080610131
5300	93	154	13	53,00	1	080610153
8000	108	179	16	64,50	1	080610180

8062

ganci scorsoi,
acciaio legato ad alta resistenza

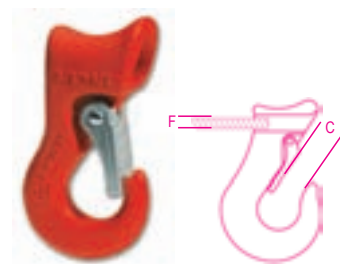

WLL kg	C mm	F mm	€		
1500	19	10-13	29,00	1	080620013
2000	21	16	40,00	1	080620016
3000	26	18	74,00	1	080620018
5000	34	22-25	102,00	1	080620025

8064S

ganci orientabili,
acciaio al carbonio

CE

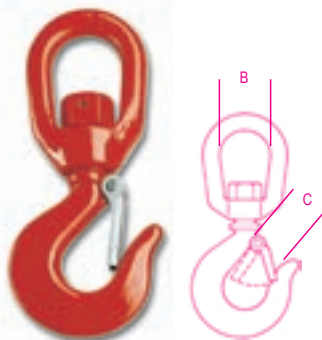

EN 1677-5
GRADO 4

WLL kg	B mm	C mm	€	📄	📦
800	31	20	23,00	1	080640107
1000	40	22	28,50	1	080640110
1600	47	23	37,00	1	080640115
2000	47	27	45,00	1	080640120
3200	64	35	79,00	1	080640130
5000	77	43	134,00	1	080640150
7500	90	53	202,00	1	080640175
10000	96	58	344,00	1	080640199

8065SC

ganci girevoli sotto carico,
con cuscinetto
acciaio al carbonio

CE

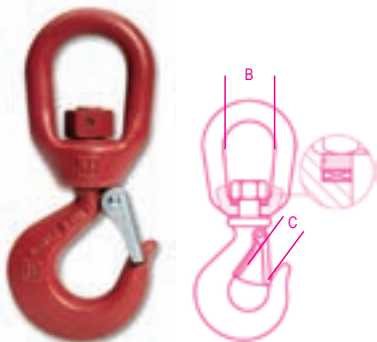

EN 1677-5
GRADO 4

WLL kg	B mm	C mm	€	📄	📦
800	31	20	43,00	1	080650107
1000	40	22	54,50	1	080650110
1600	47	23	66,00	1	080650115
2000	47	27	76,50	1	080650120
3200	64	35	139,00	1	080650130
5000	77	43	197,00	1	080650150

8050D

kit sicure di ricambio per ganci

Model	WLL kg	€	📄	📦
8050D1 8055/1250 8064S-8065SC/800	5,70	1	080500945	
8050D2 8055S/1600 8064S-8065SC/1000	6,60	1	080500946	
8050D3 8055/2500-3200 8064S-8065SC/1600-2000	7,10	1	080500947	
8050D4 8055S/5400 8064S-8065SC/3200	11,90	1	080500948	
8050D5 8055S/8000 8064S-8065SC/5000	13,90	1	080500949	
8050D6 8055S/11500 8064S/7500	22,50	1	080500950	
8050D7 8060/3150	16,50	1	080500951	

8050D8 8060/5300	21,00	1	080500952
8050D7A 8060/2000	13,50	1	080500968
8050D10 8062/1500	10,70	1	080500954
8050D11 8062/2000	12,50	1	080500955
8050D12 8062/3000	14,00	1	080500956
8050D13 8062/5000	19,00	1	080500957
8050D22 8055S/16000 8064S/10000	30,50	1	080500966
8050D23 8055S/22000	40,50	1	080500967
8050D24 8051S/250	0,50	1	080500969
8050D25 8051S/500	0,60	1	080500970
8050D26 8061F/1120	7,80	1	080500971
8050D27 8061F/2000	8,10	1	080500972
8050D28 8061F/3150	8,90	1	080500973
8050D29 8061F/5300	11,20	1	080500974
8050D30 8061F/8000	12,40	1	080500975
8050D31 8060/1120	8,50	1	080500976
8050D32 8060/8000	20,50	1	080500977

8085

campanelle,
acciaio legato ad alta resistenza

Il carico di lavoro WLL è relativo all'utilizzo con imbragature ad 1 braccio.

CE

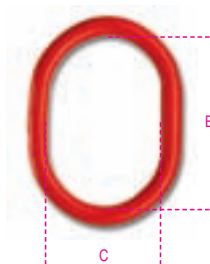

EN 1677-4
GRADO 8

WLL kg	Ø mm	B mm	C mm	€	📄	📦
* 1500	7	110	60	16,00	1	080850016
2000	8	110	60	19,50	1	080850020
3150	10	135	75	24,00	1	080850032
5300	13	160	90	35,00	1	080850054
8000	16	180	100	49,50	1	080850080
11200	19	200	110	80,00	1	080850190

* Abbinata a catena Ø 6, WLL= 1120 kg

8086

campanelle triple,
acciaio legato ad alta resistenza

Il carico di lavoro WLL è relativo all'utilizzo con imbragature a 3 o 4 bracci e angolo β inferiore a 45°

CE



EN 1677-4
GRADO 8

WLL kg	Ø mm	B mm	C mm	€	📄	📦
* 3150	7	135	75	49,50	1	080860021
4250	8	160	90	72,50	1	080860042
6700	10	180	100	94,00	1	080860067
11200	13	200	110	164,00	1	080860100
17000	16	260	140	232,00	1	080860117

* Abbinata a catena Ø 6mm, WLL= 2360 kg

8090

maglie di giunzione,
acciaio legato ad alta resistenza

CE

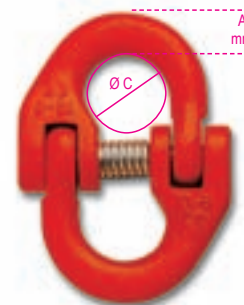

EN 1677-1
GRADO 8

WLL kg	Ø mm	ØC max	A mm	€	📄	📦
1120	6	13	7	14,50	1	080900011
2000	7-8	18	9,5	17,50	1	080900020
3150	10	22	12	22,00	1	080900032
5300	13	26	17	32,50	1	080900053
8000	16	32	22	49,00	1	080900080

8090F

maglie di giunzione per brache in poliestere,
acciaio legato ad alta resistenza

CE

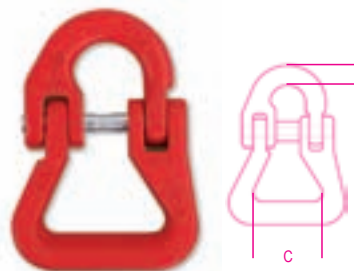

EN 1677-1
GRADO 8

WLL kg	A mm	C mm	Ø mm	€	📄	📦
2000	10,5	40	7-8	22,50	1	080900220
3150	12	50	10	27,00	1	080900232
5300	17	60	13	41,00	1	080900253
8000	21	75	16	63,00	1	080900280

Robur

8100

catene,
acciaio legato ad alta resistenza

CE



EN 818-2
GRADO 8

WLL kg	A mm	B mm	C mm	€/m	📦	🚚
1120	18	7,8	6	18,00	1	081000011
1500	21	9,1	7	20,70	1	081000016
2000	24	10,4	8	24,50	1	081000020
3150	30	13	10	35,00	1	081000032
5300	39	16,9	13	57,00	1	081000053
8000	48	20,8	16	80,00	1	081000080

PENDENTI DI CATENA Grado 8

WLL Ton

UNI EN 818

Ø D mm	Diagram	Diagram	
		0° < β ≤ 45°	45° < β ≤ 60°
		Factor 1,4	Factor 1
6	1,12	1,6	1,12
7	1,5	2,12	1,5
8	2	2,8	2
10	3,15	4,25	3,15
13	5,3	7,5	5,3
16	8	11,2	8

Ø D mm	Diagram	Diagram	
		0° < β ≤ 45°	45° < β ≤ 60°
		Factor 2,1	Factor 1,5
6	1,12	2,36	1,7
7	1,5	3,15	2,24
8	2	4,25	3
10	3,15	6,7	4,75
13	5,3	11,2	8
16	8	17	11,2

8091

pendenti di catena ad 1 braccio
in valigetta

CE

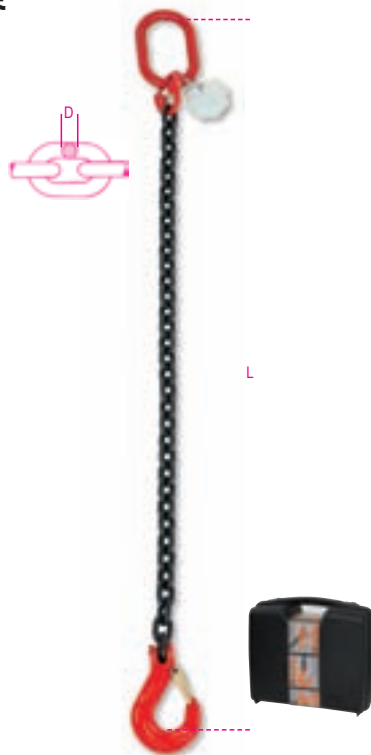

UNI EN 818-4

D mm	L m	WLL ton	€	📦	🚚
6	1	1,12	90,50	1	080910061
6	2	1,12	112,00	1	080910062
6	3	1,12	133,50	1	080910063
6	4	1,12	151,50	1	080910064
7	1	1,5	89,50	1	080910071
7	2	1,5	114,50	1	080910072
7	3	1,5	139,00	1	080910073
7	4	1,5	160,00	1	080910074
8	1	2	97,50	1	080910081
8	2	2	126,50	1	080910082
8	3	2	152,00	1	080910083
8	4	2	179,50	1	080910084
10	1	3,15	140,50	1	080910101
10	2	3,15	173,00	1	080910102
10	3	3,15	216,50	1	080910103
10	4	3,15	247,50	1	080910104
13	1	5,3	208,00	1	080910131
13	2	5,3	263,00	1	080910132
13	3	5,3	320,00	1	080910133
13	4	5,3	381,00	1	080910134
16	1	8	299,00	1	080910161
16	2	8	379,00	1	080910162
16	3	8	465,00	1	080910163
16*	4	8	551,00	1	080910164

* Imballo di legno adeguato al peso

8092

pendenti di catena a 2 bracci
in valigetta

CE



UNI EN 818-4

D mm	L m	WLL ton	€	📦	🚚
6	1	1,6	147,00	1	080920061
6	2	1,6	183,50	1	080920062
6	3	1,6	219,50	1	080920063
6	4	1,6	258,00	1	080920064
7	1	2,12	154,00	1	080920071
7	2	2,12	200,00	1	080920072
7	3	2,12	242,00	1	080920073
7	4	2,12	282,00	1	080920074
8	1	2,8	161,00	1	080920081
8	2	2,8	211,50	1	080920082
8	3	2,8	260,00	1	080920083
8	4	2,8	313,00	1	080920084
10	1	4,25	238,50	1	080920101
10	2	4,25	310,00	1	080920102
10	3	4,25	382,00	1	080920103
10	4	4,25	456,00	1	080920104
13	1	7,5	354,00	1	080920131
13	2	7,5	478,00	1	080920132
13*	3	7,5	596,00	1	080920133
13*	4	7,5	701,00	1	080920134
16	1	11,2	548,00	1	080920161
16*	2	11,2	699,00	1	080920162
16*	3	11,2	859,00	1	080920163
16*	4	11,2	1.019,00	1	080920164

* Imballo di legno adeguato al peso

8094

pendenti di catena a 4 bracci
in valigetta

CE



UNI EN 818-4

D mm	L m	WLL ton	€		
6	1	2,36	287,00	1	080940061
6	2	2,36	362,00	1	080940062
6	3	2,36	441,00	1	080940063
6	4	2,36	517,00	1	080940064
7	1	3,15	287,00	1	080940071
7	2	3,15	369,00	1	080940072
7	3	3,15	460,00	1	080940073
7	4	3,15	548,00	1	080940074
8	1	4,25	319,00	1	080940081
8	2	4,25	426,00	1	080940082
8*	3	4,25	530,00	1	080940083
8*	4	4,25	620,00	1	080940084
10	1	6,7	478,00	1	080940101
10*	2	6,7	598,00	1	080940102
10*	3	6,7	753,00	1	080940103
10*	4	6,7	893,00	1	080940104
13*	1	11,2	749,00	1	080940131
13*	2	11,2	977,00	1	080940132
13*	3	11,2	1.205,00	1	080940133
13*	4	11,2	1.430,00	1	080940134
16*	1	17	1.115,00	1	080940161
16*	2	17	1.435,00	1	080940162
16*	3	17	1.755,00	1	080940163
16*	4	17	2.075,00	1	080940164

* Imballo di legno adeguato al peso

Robur

8096

pendenti di catena ad 1 braccio
con gancio accorciatore,
in valigetta

CE



UNI EN 818-4

D mm	L m	WLL ton	€		
6	1	1,12	118,00	1	080960061
6	2	1,12	140,00	1	080960062
6	3	1,12	157,50	1	080960063
6	4	1,12	174,00	1	080960064
7	1	1,5	120,00	1	080960071
7	2	1,5	141,50	1	080960072
7	3	1,5	161,00	1	080960073
7	4	1,5	180,50	1	080960074
8	1	2	129,00	1	080960081
8	2	2	154,50	1	080960082
8	3	2	178,50	1	080960083
8	4	2	209,50	1	080960084
10	1	3,15	180,00	1	080960101
10	2	3,15	223,50	1	080960102
10	3	3,15	254,00	1	080960103
10	4	3,15	293,00	1	080960104
13	1	5,3	278,00	1	080960131
13	2	5,3	313,00	1	080960132
13	3	5,3	377,00	1	080960133
13	4	5,3	453,00	1	080960134
16	1	8	385,00	1	080960161
16	2	8	448,00	1	080960162
16	3	8	534,00	1	080960163
16*	4	8	606,00	1	080960164

* Imballo di legno adeguato al peso

8097

pendenti di catena a 2 bracci
con ganci accorciatori,
in valigetta

CE



UNI EN 818-4

D mm	L m	WLL ton	€		
6	1	1,6	195,00	1	080970061
6	2	1,6	223,00	1	080970062
6	3	1,6	266,00	1	080970063
6	4	1,6	300,00	1	080970064
7	1	2,12	204,00	1	080970071
7	2	2,12	239,00	1	080970072
7	3	2,12	284,00	1	080970073
7	4	2,12	323,00	1	080970074
8	1	2,8	212,50	1	080970081
8	2	2,8	254,00	1	080970082
8	3	2,8	318,00	1	080970083
8	4	2,8	364,00	1	080970084
10	1	4,25	323,00	1	080970101
10	2	4,25	391,00	1	080970102
10	3	4,25	469,00	1	080970103
10	4	4,25	543,00	1	080970104
13	1	7,5	506,00	1	080970131
13	2	7,5	626,00	1	080970132
13*	3	7,5	693,00	1	080970133
13*	4	7,5	807,00	1	080970134
16	1	11,2	681,00	1	080970161
16*	2	11,2	828,00	1	080970162
16*	3	11,2	988,00	1	080970163
16*	4	11,2	1.148,00	1	080970164

* Imballo di legno adeguato al peso

Robur

Robur

8098

pendenti di catena a 4 bracci con ganci accorciatori, in valigetta

CE



UNI EN 818-4

D mm	L m	WLL ton	€	🚚	📦
6	1	2,36	380,00	1	080980061
6	2	2,36	444,00	1	080980062
6	3	2,36	524,00	1	080980063
6	4	2,36	600,00	1	080980064
7	1	3,15	390,00	1	080980071
7	2	3,15	461,00	1	080980072
7	3	3,15	552,00	1	080980073
7	4	3,15	638,00	1	080980074
8	1	4,25	410,00	1	080980081
8	2	4,25	517,00	1	080980082
8*	3	4,25	621,00	1	080980083
8*	4	4,25	706,00	1	080980084
10	1	6,7	607,00	1	080980101
10*	2	6,7	735,00	1	080980102
10*	3	6,7	875,00	1	080980103
10*	4	6,7	1.015,00	1	080980104
13*	1	11,2	961,00	1	080980131
13*	2	11,2	1.189,00	1	080980132
13*	3	11,2	1.430,00	1	080980133
13*	4	11,2	1.645,00	1	080980134
16*	1	17	1.375,00	1	080980161
16*	2	17	1.695,00	1	080980162
16*	3	17	2.015,00	1	080980163
16*	4	17	2.335,00	1	080980164

* Imballo di legno adeguato al peso

BRACHE DI NASTRO in poliестere

			$\beta=0^\circ-45^\circ$	$\beta=45^\circ-60^\circ$
30	1t	0,8t	1,4t	1t
60	2t	1,6t	2,8t	2t
90	3t	2,4t	4,2t	3t
120	4t	3,2t	5,6t	4t
150	5t	4,0t	7,0t	5t
180	6t	4,8t	8,4t	6t
240	8t	6,4t	11,2t	8t
300	10t	8,0t	14,0t	10t

8150

brache di nastro tessuto piatto, 1t in poliестere ad alta tenacità (PES) colore viola

CE



UNI EN 1492-1

L m	H mm	WLL ton	€	🚚	📦
1	30	1	6,60	1	081500010
1,5	30	1	8,70	1	081500015
2	30	1	10,80	1	081500020
2,5	30	1	13,00	1	081500025
3	30	1	15,80	1	081500030
4	30	1	19,50	1	081500040
5	30	1	25,50	1	081500050
6	30	1	30,00	1	081500060
8	30	1	40,00	1	081500080

8153

brache di nastro tessuto piatto, 2t in poliестere ad alta tenacità (PES) colore verde

CE



UNI EN 1492-1

L m	H mm	WLL ton	€	🚚	📦
1	60	2	12,20	1	081530010
1,5	60	2	16,30	1	081530015
2	60	2	20,40	1	081530020
2,5	60	2	25,00	1	081530025

L m	H mm	WLL ton	€	🚚	📦
3	60	2	30,00	1	081530030
4	60	2	37,00	1	081530040
5	60	2	44,00	1	081530050
6	60	2	51,00	1	081530060
8	60	2	66,00	1	081530080
10	60	2	84,00	1	081530100

8156

brache di nastro tessuto piatto, 3t in poliестere ad alta tenacità (PES) colore giallo

CE

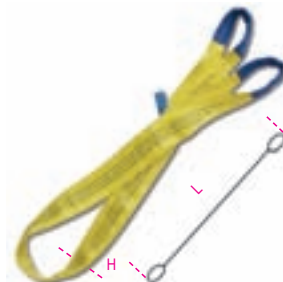

UNI EN 1492-1

L m	H mm	WLL ton	€	🚚	📦
1,5	90	3	23,50	1	081560015
2	90	3	29,50	1	081560020
2,5	90	3	36,00	1	081560025
3	90	3	42,00	1	081560030
4	90	3	54,00	1	081560040
5	90	3	67,50	1	081560050
6	90	3	78,50	1	081560060
8	90	3	102,00	1	081560080
10	90	3	125,00	1	081560100

8157

brache di nastro tessuto piatto, 4t in poliестere ad alta tenacità (PES) colore grigio

CE



UNI EN 1492-1

L m	H mm	WLL ton	€	🚚	📦
2	120	4	39,00	1	081570020
3	120	4	56,00	1	081570030
4	120	4	72,50	1	081570040
5	120	4	89,50	1	081570050
6	120	4	106,00	1	081570060
8	120	4	140,50	1	081570080
10	120	4	172,00	1	081570100

Robur

Robur

8158

brache di nastro tessuto piatto, 5t
in poliestere ad alta tenacità (PES)
colore rosso

CE



UNI EN 1492-1

L m	H mm	WLL ton	€		
2	150	5	50,00	1	081580020
3	150	5	71,50	1	081580030
4	150	5	95,00	1	081580040
5	150	5	115,00	1	081580050
6	150	5	135,00	1	081580060
8	150	5	178,50	1	081580080
10	150	5	220,00	1	081580100

8159

brache di nastro tessuto piatto, 6t
in poliestere ad alta tenacità (PES)
colore marrone

CE



UNI EN 1492-1

L m	H mm	WLL ton	€		
3	180	6	90,00	1	081590030
4	180	6	117,00	1	081590040
5	180	6	145,00	1	081590050
6	180	6	172,00	1	081590060
8	180	6	225,00	1	081590080
10	180	6	280,00	1	081590100

8160

brache di nastro tessuto piatto, 8t
in poliestere ad alta tenacità (PES)
colore blu

CE



UNI EN 1492-1

L m	H mm	WLL ton	€		
5	240	8	194,00	1	081600050
6	240	8	230,00	1	081600060
8	240	8	300,00	1	081600080
10	240	8	370,00	1	081600100

8161

brache di nastro tessuto piatto, 10t
in poliestere ad alta tenacità (PES)
colore arancio

CE



UNI EN 1492-1

L m	H mm	WLL ton	€		
5	300	10	260,00	1	081610050
6	300	10	305,00	1	081610060
8	300	10	400,00	1	081610080
10	300	10	495,00	1	081610100

8170

brache ad anello continuo, 1t
tessuto in poliestere ad alta tenacità (PES)
colore viola

CE

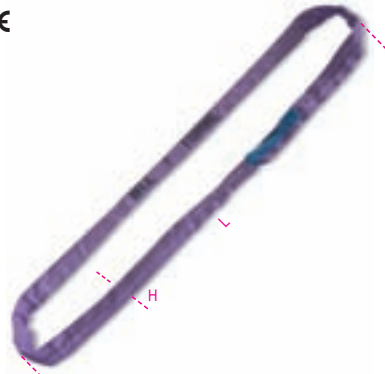

UNI EN 1492-2

L m	H mm	WLL ton	€		
0,5	45	1	6,30	1	081700010
1	45	1	7,65	1	081700020
1,5	45	1	11,20	1	081700030
2	45	1	15,30	1	081700040
3	45	1	22,40	1	081700060
4	45	1	29,50	1	081700080

8173

brache ad anello continuo, 2t
tessuto in poliestere ad alta tenacità (PES)
colore verde

CE



UNI EN 1492-2

L m	H mm	WLL ton	€		
0,5	50	2	8,60	1	081730010
1	50	2	11,70	1	081730020
1,5	50	2	16,60	1	081730030
2	50	2	22,00	1	081730040
2,5	50	2	27,50	1	081730050
3	50	2	32,50	1	081730060
4	50	2	42,00	1	081730080

8176

brache ad anello continuo, 3t
tessuto in poliestere ad alta tenacità (PES)
colore giallo

CE



UNI EN 1492-2

L m	H mm	WLL ton	€		
1	60	3	14,50	1	081760020
1,5	60	3	21,50	1	081760030
2	60	3	28,50	1	081760040
2,5	60	3	36,00	1	081760050
3	60	3	43,00	1	081760060
4	60	3	56,50	1	081760080
5	60	3	71,00	1	081760100

8177

brache ad anello continuo, 4t
tessuto in poliestere ad alta tenacità (PES)
colore grigio

CE



UNI EN 1492-2

L m	H mm	WLL ton	€	🚚	📦
1	65	4	20,40	1	081770020
1,5	65	4	31,00	1	081770030
2	65	4	41,00	1	081770040
2,5	65	4	51,00	1	081770050
3	65	4	60,00	1	081770060
4	65	4	79,50	1	081770080
5	65	4	90,00	1	081770100
6	65	4	106,00	1	081770120
8	65	4	141,00	1	081770160

8178

brache ad anello continuo, 5t
tessuto in poliestere ad alta tenacità (PES)
colore rosso

CE

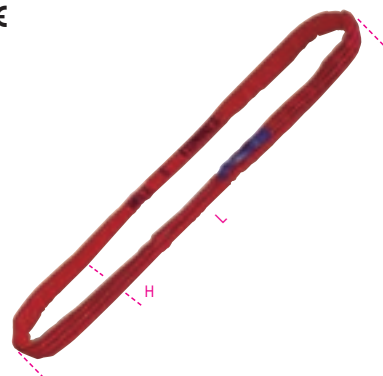

UNI EN 1492-2

L m	H mm	WLL ton	€	🚚	📦
1	70	5	24,50	1	081780020
1,5	70	5	36,00	1	081780030
2	70	5	49,50	1	081780040
2,5	70	5	61,00	1	081780050
3	70	5	73,50	1	081780060
4	70	5	100,00	1	081780080
5	70	5	121,00	1	081780100
6	70	5	136,00	1	081780120
8	70	5	179,00	1	081780160

8166

guaine antiabrasione per brache di sollevamento,
in poliestere ad alta tenacità (PES)
con sottostato elastomerico



H mm	ø mm	L m	€	🚚	📦
70	45	3	17,50	1	081660073
80	52	3	21,00	1	081660083
110	70	3	25,50	1	081660103

**SISTEMI DI ANCORAGGIO
E LEGATURA
COEFFICIENTE 2:1
SECONDO UNI EN 12195**

8180

sistemi di ancoraggio a cricchetto LC 750kg
nastro in poliestere ad alta tenacità (PES)
ganci a uncino

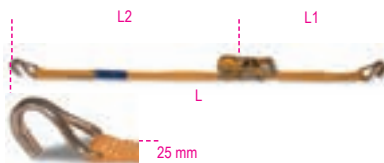

EN 12195-2

L m	L2 mm	L1 mm	€	🚚	📦
4	3700	300	20,00	1	081800004
6	5700	300	22,00	1	081800006
8	7700	300	24,80	1	081800008

LC = 750 kg

8181

sistemi di ancoraggio a cricchetto LC 1000kg
nastro in poliestere ad alta tenacità (PES)
ganci a uncino

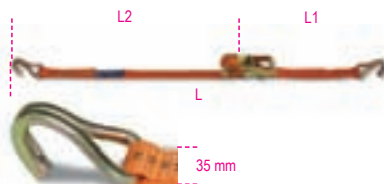

EN 12195-2

L m	L2 mm	L1 mm	€	🚚	📦
4	3700	300	31,50	1	081810004
6	5700	300	34,50	1	081810006
8	7700	300	37,50	1	081810008

LC = 1000 kg

8182

sistemi di ancoraggio a cricchetto LC 2000kg
nastro in poliestere ad alta tenacità (PES)
ganci a uncino

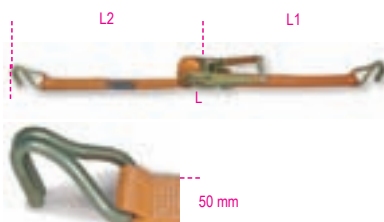

EN 12195-2

L m	L2 mm	L1 mm	€	🚚	📦
6,5	6000	500	37,50	1	081820065
8,5	8000	500	43,00	1	081820085
10,5	10000	500	47,50	1	081820105

LC = 2000 kg

8182S

sistemi di ancoraggio a cricchetto LC 2000kg
nastro in poliestere ad alta tenacità (PES)
ganci sponda

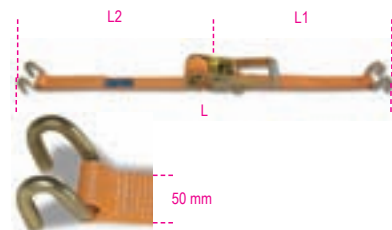

EN 12195-2

L m	L2 mm	L1 mm	€	🚚	📦
8,5	8000	500	41,50	1	081820285
10,5	10000	500	45,50	1	081820305

LC = 2000 kg

8185

sistemi di ancoraggio ad anello LC 1500kg
con cricchetto tenditore
nastro in poliestere ad alta tenacità (PES)

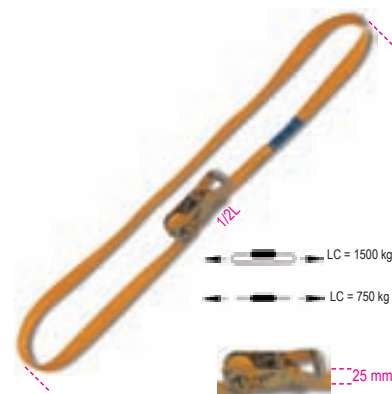

EN 12195-2

L m	€	🚚	📦
5	17,50	1	081850005
8	21,50	1	081850008

8186

sistemi di ancoraggio ad anello LC 2000kg
con cricchetto tenditore
nastro in poliestere ad alta tenacità (PES)

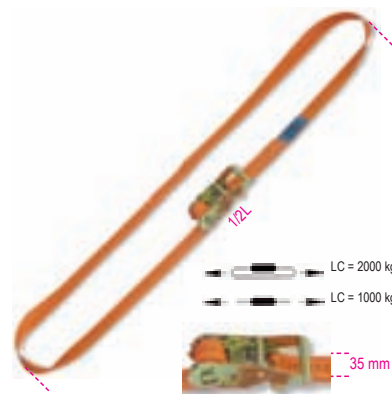

EN 12195-2

L m	€	🚚	📦
5	21,50	1	081860005
8	26,50	1	081860008

8187

sistemi di ancoraggio ad anello LC 4000kg
con cricchetto tenditore
nastro in poliestere ad alta tenacità (PES)



EN 12195-2

L m	€	1	081870005
5	29,50	1	081870005
8	31,50	1	081870008

8188C

sistemi di legatura ad anello LC 750kg
con cricchetto tenditore
nastro in poliestere ad alta tenacità (PES)

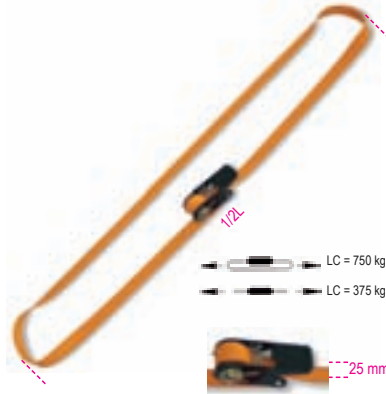

EN 12195-2

L m	€	3	081880350
5	5,70	3	081880350

8188FG3

sistemi di legatura con 3 ganci ed asole,
fibbia di serraggio LC 250kg
nastro in polipropilene ad alta tenacità (PP)

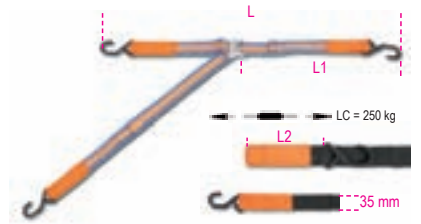

EN 12195-2

L max m	L min m	L1 mm	L2 mm	€	1	081880630
3,5	0,85	450	170	15,00	1	081880630

8188F

sistemi di legatura ad anello LC 230kg
con fibbia di serraggio
nastro in polipropilene ad alta tenacità (PP)

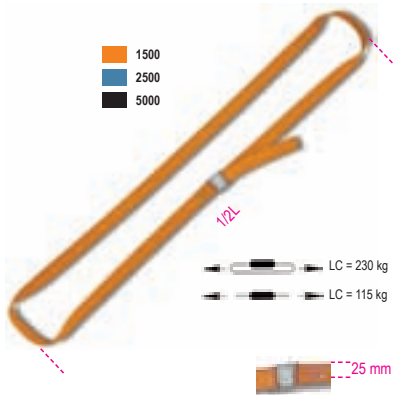

EN 12195-2

L m	€	10	081880215
1,5	2,10	10	081880215
2,5	2,50	10	081880225
5,0	3,50	6	081880250

8188CG/25

sistemi di legatura con 2 ganci ed asole,
cricchetto tenditore LC 375kg
nastro in poliestere ad alta tenacità (PES)



EN 12195-2

L m	L1 mm	L2 mm	€	1	081880430
3	480	170	9,00	1	081880430
5	480	170	10,00	1	081880450

8188F/35

sistemi di legatura ad anello LC 500kg
con fibbia di serraggio
nastro in polipropilene ad alta tenacità (PP)

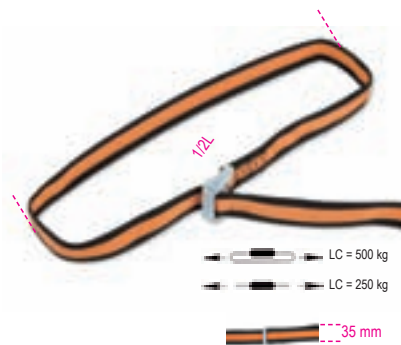

EN 12195-2

L m	€	3	081880290
4	8,00	3	081880290

8188FG2

sistemi di legatura con 2 ganci ed asole,
fibbia di serraggio LC 250kg
nastro in polipropilene ad alta tenacità (PP)



EN 12195-2

L m	L1 mm	L2 mm	€	1	081880530
3	450	170	11,00	1	081880530



8205

tenditore a due occhi
inox AISI 316

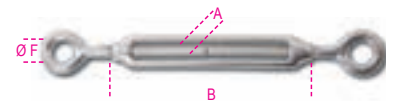

A mm	B mm	Ø F mm	WFL kg	€	10	082050204
M4	62	8	75	4,60	10	082050204
M5	72	11	115	5,40	10	082050205
M6	92	12	160	7,20	5	082050206
M8	122	14	300	11,20	5	082050208
M10	150	16	470	17,50	1	082050210
M12	201	18	690	30,00	1	082050212
M14	225	22	940	68,00	1	082050214
M16	244	26	1290	71,00	1	082050216
M20	295	29	2130	112,00	1	082050220
M24	350	33	3060	244,00	1	082050224

8206

tenditore ad occhio e gancio
inox AISI 316

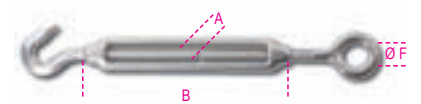

A mm	B mm	Ø F mm	WFL kg	€	10	082060205
M5	72	11	25	5,40	10	082060205
M6	92	12	45	7,20	5	082060206
M8	122	14	95	11,20	5	082060208
M10	150	16	140	17,50	1	082060210
M12	201	18	300	30,00	1	082060212
M14	225	22	420	68,00	1	082060214
M16	244	26	570	71,00	1	082060216
M20	295	29	875	112,00	1	082060220

8207

tenditore a due ganci
inox AISI 316

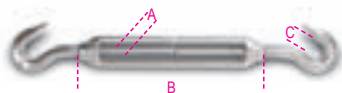

A	B	C	WFL	€		
mm	mm	mm	kg			
M5	72	9	25	5,40	10	082070205
M6	92	9	45	7,20	5	082070206
M8	122	10	95	11,20	5	082070208
M10	150	12	140	17,50	1	082070210
M12	201	14	300	30,00	1	082070212
M14	225	15	420	68,00	1	082070214
M16	244	16	570	71,00	1	082070216
M20	295	19	875	112,00	1	082070220

8209

tenditore a due forcelle
inox AISI 316

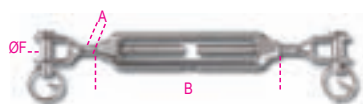

A	B	øF	WFL	€		
mm	mm	mm	kg			
M5	72	5	115	9,20	5	082090205
M6	92	6	160	11,10	5	082090206
M8	122	8	300	16,10	5	082090208
M10	150	10	470	26,50	1	082090210
M12	201	12	690	43,50	1	082090212
M14	225	14	940	57,50	1	082090214
M16	244	16	1290	89,50	1	082090216
M20	295	20	2130	153,00	1	082090220
M24	350	24	3060	340,00	1	082090224

8210

tenditore a due forcelle con canala a tubo
inox AISI 316

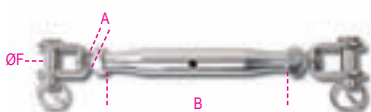

A	B	øF	WFL	€		
mm	mm	mm	kg			
M5	81	5	115	11,20	3	082100205
M6	92	6	160	13,80	3	082100206
M8	112	8	300	20,60	1	082100208
M10	121	10	470	32,50	1	082100210
M12	150	12	690	49,50	1	082100212
M14	169	14	940	69,00	1	082100214
M16	190	16	1290	107,00	1	082100216
M20	220	20	2130	175,00	1	082100220

8216

morsetti
inox AISI 316

CE

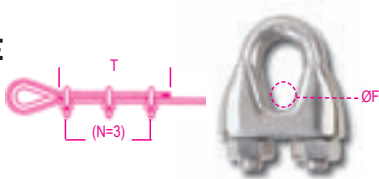

øF	"	T	N	€		
mm						
2	5/64	80	3	2,20	15	082160202
3	1/8	80	3	2,25	15	082160203
4	5/32	80	3	2,55	10	082160204
5	3/16	110	3	2,95	10	082160205
6	1/4	120	5	3,45	10	082160206
8	5/16	210	5	4,40	5	082160208

øF	"	T	N	€		
mm						
10	3/8	240	5	6,25	5	082160210
12-13	1/2	300	5	8,25	5	082160213
16	5/8	335	5	12,40	5	082160216
20	3/4	540	5	15,70	5	082160220

8220

radance, tipo pesante
inox AISI 316

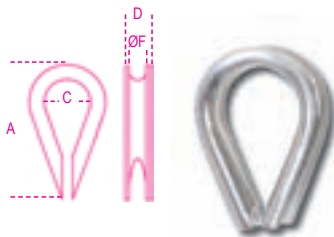

øF	D	A	C	€		
mm	mm	mm	mm			
2	4,5	21	7,5	0,80	15	082200202
3	6	24	10	0,80	15	082200203
4	6,6	28	11	0,95	10	082200204
5	8,5	30	13	1,15	10	082200205
6	10	37	15	1,30	10	082200206
8	12,5	51	23	1,90	5	082200208
10	14,6	56	27	2,35	5	082200210
12	18	68	32	3,20	5	082200212
14	19	69	34	4,55	5	082200214
16	22	83	37	5,10	5	082200216
18	23	81	38	6,25	1	082200218
20	27,8	105	45	7,35	1	082200220

8225

grilli diritti
inox AISI 316



øD	"	A	WFL	€		
mm		mm	kg			
4	5/32	8	50	2,40	10	082250204
5	3/16	11	70	2,50	10	082250205
6	1/4	13	100	3,05	5	082250206
8	5/16	17	250	4,90	5	082250208
10	3/8	21	400	7,20	3	082250210
12	1/2	25	600	11,40	3	082250212
16	5/8	32	1000	23,90	1	082250216
19	3/4	38	1600	39,50	1	082250219
22	7/8	43	2000	63,00	1	082250222
25	1	46	2800	93,00	1	082250225

8227

grilli diritti lunghi
inox AISI 316



øD	"	A	WFL	€		
mm		mm	kg			
4	5/32	8	50	2,05	10	082270204
5	3/16	10	70	2,85	10	082270205
6	1/4	13,5	100	3,65	5	082270206
8	5/16	17	250	6,10	5	082270208
10	3/8	21	400	9,80	1	082270210
12	1/2	25	600	15,90	1	082270212

8228

grilli a lira
inox AISI 316

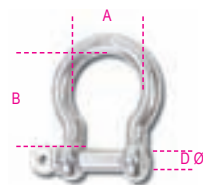

øD	A	B	WFL	€		
mm	mm	mm	kg			
4	13	20	60	2,55	10	082280204
5	17	23	80	3,05	10	082280205
6	20	27	100	3,35	10	082280206
8	28	36	200	5,60	5	082280208
10	36	44	300	8,55	5	082280210
12	41	53	500	14,30	5	082280212
16	54	74	800	31,50	1	082280216
19	66	86	1100	50,50	1	082280219

8240

golfari maschi
inox AISI 316



A	B	øC	WFL	€		
mm	mm	mm	kg			
M6	41	15	75	2,75	10	082400206
M8	50	20	140	3,90	10	082400208
M10	62	25	230	6,00	5	082400210
M12	74	30	340	10,00	5	082400212

8240F

golfari maschi FORGIATI
acciaio inox A4

CE



DIN 580:2010

ø	"	WLL	€		
mm	mm	kg			
* M10	1,5	400	8,65	1	082400410
* M12	1,75	600	14,00	1	082400412
* M14	2	1000	22,70	1	082400414
* M16	2	1200	22,70	1	082400416
* M20	2,5	2000	36,50	1	082400420
* M24	3	2700	68,00	1	082400424
M30	3,5	3200	149,00	1	082400430

(*) WLL incrementato rispetto a norma DIN
in base a Fascicolo Tecnico R/FT/8240F
(garantito per accoppiamenti inox-inox)

8242

golfari femmina
inox AISI 316



A	B	øC	WFL	€		
mm	mm	mm	kg			
M6	27	15	75	2,75	10	082420206
M8	36	20	140	3,90	10	082420208
M10	45	25	230	6,00	5	082420210
M12	55	30	340	10,00	5	082420212

8242F

golfari femmina FORGIATI
acciaio inox A4

CE



DIN 582:2010

ø	WLL	€		
mm	kg			
* M10	1,5 400	8,65	1	082420410
* M12	1,75 600	14,00	1	082420412
* M14	2 1000	22,70	1	082420414
* M16	2 1200	22,70	1	082420416
* M20	2,5 2000	36,50	1	082420420
* M24	3 2700	68,00	1	082420424
M30	3,5 3200	149,00	1	082420430

(*) WLL incrementato rispetto a norma DIN
in base a Fascicolo Tecnico R/FT/8240F
(garantito per accoppiamenti inox-inox)

8249

viti ad occhio per tasselli
inox AISI 316



A	øB	D	WFL	€		
mm	mm	mm	kg			
M5	11	50	100	1,70	10	082490205
M6	13	55	160	2,20	10	082490206
M8	17	60	300	3,60	5	082490208
M10	21	80	470	6,70	5	082490210
M12	25	120	690	11,90	1	082490212

8250

moschettoni a gancio con sicura
inox AISI 316



L	A	øB	WFL	€		
mm	mm	mm	kg			
50	25	8	45	3,05	5	082500205
70	31	12,5	90	4,55	5	082500207
100	47	20	190	7,60	1	082500210

8264

moschettoni a girello
inox AISI 316



B	L	C	WFL	€		
mm	mm	mm	kg			
12	88	12	60	8,15	5	082640212
16	90	12	60	8,25	5	082640216
19	93	12	60	8,35	1	082640219
25	100	12	60	8,50	1	082640225

8267

moschettoni a gancio con girello e sicura
inox AISI 316



A	L	B	WFL	€		
mm	mm	mm	kg			
10	87	21	30	7,20	5	082670210
12	118	22	70	12,40	1	082670213

8272

girelli a due occhi
inox AISI 316

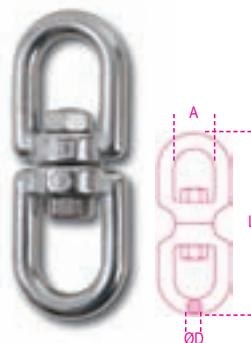

øD	A	L	WFL	€		
mm	mm	mm	kg			
4	11	50	90	4,05	5	082720204
5	13	60	115	5,15	5	082720205
6	15	66	140	6,50	5	082720206
8	19	90	250	10,70	3	082720208
10	23	112	300	16,70	1	082720210
13	33	148	650	35,00	1	082720213
16	38	184	1000	62,50	1	082720216
19	40	223	1600	117,50	1	082720219

8273

moschettoni a sgancio rapido
con occhio girevole
inox AISI 316



øC x L	B	WFL	BF	€		
mm	mm	kg	kg			
12x70	12	230	1100	12,50	1	082730012
16x85	14,50	440	2000	17,00	1	082730016
22x120	20	700	3500	27,00	1	082730022

8274

moschettoni
inox AISI 316

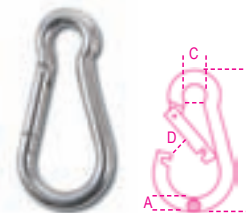

øA x L	øC	D	WFL	€		
mm	mm	mm	kg			
4,5x40	6,5	6	20	2,15	10	082740204
5x50	8	7	30	2,25	10	082740205
6x60	8,5	7,5	40	2,85	5	082740206
7x70	10	9	60	3,80	5	082740207
8x80	12	10	75	4,95	5	082740208
9x90	12,5	10,5	100	6,80	5	082740209
10x100	15	13	120	8,30	1	082740210
11x120	19	18	140	11,20	1	082740211
12x140	22	21	140	14,50	1	082740212
13x160	22	26	200	18,70	1	082740213

8274G

moschettoni con ghiera
inox AISI 316

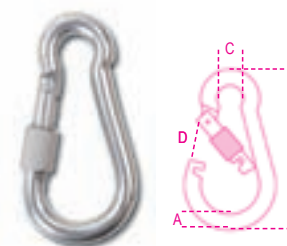

øA x L	øC	D	WFL	€		
mm	mm	mm	kg			
6x60	8,5	6,5	40	3,95	5	082740306
8x80	12	8,5	75	6,80	5	082740308
10x100	15	12	120	11,30	3	082740310

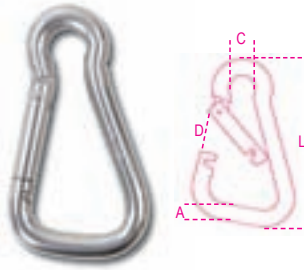
8276moschettoni asimmetrici
inox AISI 316

ø A x L mm	ø C mm	D mm	WFL kg	€		
6x60	8,5	10	40	3,20	5	082760206
8x80	12	14	75	5,50	5	082760208
10x100	15	18	120	10,10	3	082760210

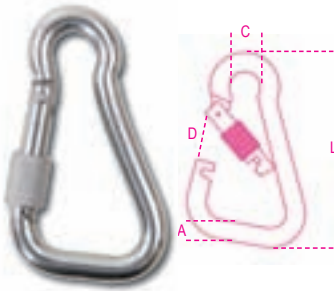
8276Gmoschettoni asimmetrici con ghiera
inox AISI 316

ø A x L mm	ø C mm	D mm	WFL kg	€		
6x60	8,5	9	40	4,50	3	082760306
8x80	12	12,5	75	7,60	3	082760308
10x100	15	16	120	13,60	3	082760310

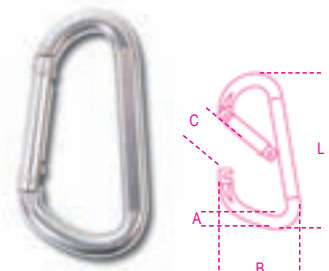
8278moschettoni trapezoidali
inox AISI 316

ø A x L mm	B mm	C mm	WFL kg	€		
8x80	45	14	75	8,70	3	082780208
10x100	55	16	120	13,90	3	082780210

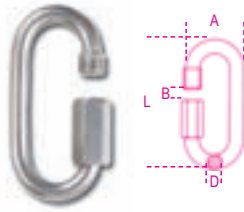
8280maglie di giunzione
inox AISI 316

ø D x L mm	A mm	B mm	WFL kg	€		
3,5x35	17	5	20	2,30	10	082800203
4x40	19	6	30	2,35	10	082800204
5x50	23	7	50	2,95	5	082800205
6x60	26	8	60	3,50	5	082800206
7x70	30	9	100	4,10	5	082800207
8x80	33	10	140	5,75	1	082800208
10x90	40	12	220	9,50	1	082800210
12x100	47	14	300	14,70	1	082800212

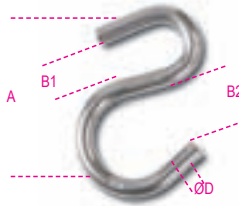
8282ganci a "S"
inox AISI 316

ø D mm	A mm	B1 mm	B2 mm	€		
3	31	7,5	14	0,80	10	082820203
4	37	10,5	14,5	0,95	10	082820204
5	44	12,5	16	1,45	10	082820205
6	51	12,5	18	1,95	5	082820206
8	68	14	23	3,80	5	082820208

8284moschettoni a pellicano
inox AISI 316

ø C mm	B mm	L mm	WFL kg	€		
6	11	73	200	10,50	3	082840006
8	14	98	300	14,00	3	082840008
10	23	143	450	29,00	1	082840010

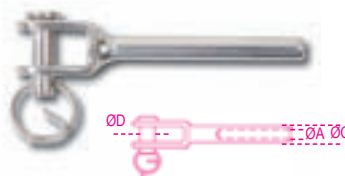
8285terminali a forcella
inox AISI 316

ø A mm	ø C mm	ø D mm	WFL kg	€		
3	6,3	6	180	5,05	5	082850203
4	7,5	6	200	6,10	3	082850204
5	9	10	330	9,15	1	082850205
6	12,5	12	720	14,40	1	082850206
8	16	13	1120	23,70	1	082850208

8286terminali ad occhio
inox AISI 316

ø D mm	ø A mm	ø C mm	WFL kg	€		
3	6,5	6,3	180	5,20	5	082860203
4	8,5	7,5	200	6,30	3	082860204
5	10,6	9	330	8,55	1	082860205
6	13	12,5	720	13,30	1	082860206
8	14,7	16	1120	22,00	1	082860208

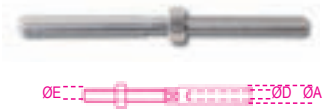
8287terminali a tubo
inox AISI 316

ø D mm	ø A mm	E mm	WFL kg	€		
3	6,3	M6	180	3,90	5	082870203
4	7,5	M8	200	4,90	3	082870204
5	9	M10	330	6,50	1	082870205
6	12,5	M12	720	13,10	1	082870206
8	16	M16	1120	23,70	1	082870208

8290ponticelli
inox AISI 316

ø A mm	B mm	ø C mm	L mm	€		
5	18	4,3	40	1,40	5	082900205
6	22	5,2	44	1,75	5	082900206
8	23	5,2	51	2,45	5	082900208

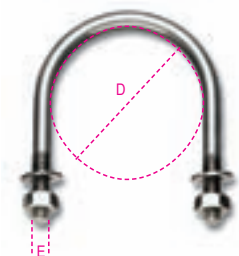
8381SXcollari per sostegno tubazioni,
acciaio inox

AISI 304

D mm	D gas	E mm	€		
11	1/8"	M6	1,55	200	083810401
14	1/4"	M6	1,60	200	083810402
18	3/8"	M6	1,65	200	083810403
22	1/2"	M6	1,65	200	083810404
27	3/4"	M6	1,70	200	083810405
34	1"	M6	1,75	200	083810406
43	1 1/4"	M6	2,00	200	083810407
49	1 1/2"	M8	3,60	100	083810408
61	2"	M8	3,80	100	083810409

Beta Collection

Il giusto stile
per vivere al meglio
il vero spirito

 **Beta**

È una linea di prodotti esclusivi pensati e realizzati come espressione del carattere Beta che comprende oltre 200 creazioni originali di altissima qualità: attrezzature sportive, abbigliamento tecnico e una molteplicità di oggettistica personalizzata. Ideali per dar vita ad iniziative promozionali, e per trascorrere momenti di svago.



9572MB

t-shirt vintage Beta-March F1 100% cotone



	€		
S	43,00	1	095720701
M	43,00	1	095720702
L	43,00	1	095720703
XL	43,00	1	095720704
XXL	43,00	1	095720705

9502

giacca realizzata in nylon, cuciture termosaldate e foderata internamente con rete di poliestere, interno maniche foderate in nylon



	€		
S	98,50	1	095020001
M	98,50	1	095020002
L	98,50	1	095020003
XL	98,50	1	095020004
XXL	98,50	1	095020005

9504

softshell antivento/antipioggia, esterno nero/interno arancio, inserto tessuto arancio e grigio su una spalla, cerniere termonastrate, logo reflective e stampa sul retro.



	€		
S	110,00	1	095040001
M	110,00	1	095040002
L	110,00	1	095040003
XL	110,00	1	095040004
XXL	110,00	1	095040005

9505

softshell antivento/antipioggia senza maniche, esterno nero/interno arancio, inserto tessuto arancio e grigio su una spalla, cerniere termonastrate, logo reflective e stampa sul retro.



	€		
S	85,00	1	095050001
M	85,00	1	095050002
L	85,00	1	095050003
XL	85,00	1	095050004
XXL	85,00	1	095050005

9500

felpa in cotone 100% rasato con cappuccio, profili in piping arancio, 330 gr., logo reflective e stampa retro.



	€		
S	76,00	1	095000001
M	76,00	1	095000002
L	76,00	1	095000003
XL	76,00	1	095000004
XXL	76,00	1	095000005

9501

felpa in cotone 100% rasato con mezza zip, profili in piping arancio, 330 gr., stampa fronte e retro loghi BETA.



	€		
S	74,00	1	095010001
M	74,00	1	095010002
L	74,00	1	095010003
XL	74,00	1	095010004
XXL	74,00	1	095010005

9510

camicia maniche corte in cotone popeline 100%, 110 gr, inserti tessuto arancio e piping bianco, bottone arancio in contrasto, logo reflective e stampa retro.



	€		
XS	65,00	1	095100000
S	65,00	1	095100001
M	65,00	1	095100002
L	65,00	1	095100003
XL	65,00	1	095100004
XXL	65,00	1	095100005

9572GG

t-shirt in cotone pettinato 100%, colore antracite, 160 gr, parasudore arancio, stampa grafica sul fronte.



	€		
XS	29,00	1	095720000
S	29,00	1	095720001
M	29,00	1	095720002
L	29,00	1	095720003
XL	29,00	1	095720004
XXL	29,00	1	095720005



9572GB

t-shirt in cotone rasato 100%, colore blu denim, 160 gr, parasudore arancio, stampa grafica sul fronte.



Dimensione	€	Icona	Icona
XS	29,00	1	095720100
S	29,00	1	095720101
M	29,00	1	095720102
L	29,00	1	095720103
XL	29,00	1	095720104
XXL	29,00	1	095720105

9572Q

t-shirt in cotone pettinato 100%, colore bianco, 160gr, parasudore arancio, stampa grafica sul fronte.



Dimensione	€	Icona	Icona
XS	29,00	1	095720600
S	29,00	1	095720601
M	29,00	1	095720602
L	29,00	1	095720603
XL	29,00	1	095720604
XXL	29,00	1	095720605

9536

giacca softshell grigio, bilaminato, elasticizzato, foderato in pile 290 g



Dimensione	€	Icona	Icona
S	69,00	1	095361011
M	69,00	1	095361012
L	69,00	1	095361013
XL	69,00	1	095361014
XXL	69,00	1	095361015

9572GC

t-shirt in cotone rasato 100%, colore corallo, 160 gr, parasudore arancio, stampa grafica sul fronte.



Dimensione	€	Icona	Icona
XS	29,00	1	095720200
S	29,00	1	095720201
M	29,00	1	095720202
L	29,00	1	095720203
XL	29,00	1	095720204
XXL	29,00	1	095720205

9503G

giacca realizzata in nylon, cuciture termosaldate e foderata internamente con rete di poliestere, interno maniche foderate in nylon



Dimensione	€	Icona	Icona
S	98,50	1	095030011
M	98,50	1	095030012
L	98,50	1	095030013
XL	98,50	1	095030014
XXL	98,50	1	095030015

9535

t-shirt manica lunga doppia, in cotone 100% 180 g, con stampa ed applicazione sul fronte e patch ricamato su manica



Dimensione	€	Icona	Icona
S	29,50	1	095350011
M	29,50	1	095350012
L	29,50	1	095350013
XL	29,50	1	095350014

9572H

t-shirt in cotone pettinato 100%, colore bianco, 160 gr, parasudore arancio



Dimensione	€	Icona	Icona
XS	29,00	1	095720500
S	29,00	1	095720501
M	29,00	1	095720502
L	29,00	1	095720503
XL	29,00	1	095720504
XXL	29,00	1	095720505

9508K

giacca con zip lunga in nylon ripstop, impermeabile, tascabile



Dimensione	€	Icona	Icona
S	26,50	1	095080011
M	26,50	1	095080012
L	26,50	1	095080013
XL	26,50	1	095080014

9534W

polo 3 bottoni in cotone piquè cardato 200 g bianco



Dimensione	€	Icona	Icona
S	30,00	1	095340011
M	30,00	1	095340012
L	30,00	1	095340013
XL	30,00	1	095340014
XXL	30,00	1	095340015

9534B

polo 3 bottoni in cotone piquè cardato 200 g blu



	€		
S	30,00	1	095340051
M	30,00	1	095340052
L	30,00	1	095340053
XL	30,00	1	095340054
XXL	30,00	1	095340055

9537

pile, 100% poliestere, nero, con finitura antipilling



	€		
M	55,00	1	095370002
L	55,00	1	095370003
XL	55,00	1	095370004
XXL	55,00	1	095370005

9593 Breil®

cronografo al quarzo Breil®, cassa in acciaio, water resistant 10ATM, datario, bracciale in acciaio bilux



9593 Breil®	€ 330,00	1	095930015
-------------	----------	---	-----------

9593CA

cronografo, cassa in acciaio, water resistant 5ATM, cinturino in pelle



9593	€ 210,00	1	095930025
------	----------	---	-----------

9593 Miami

orologio analogico, cassa in plastica, water resistant 5ATM, cinturino in silicone



9593 Miami	€ 34,00	1	095930030
------------	---------	---	-----------

9551

casco integrale by SUOMY



	€		
S	520,00	1	095510055
M	520,00	1	095510057
L	520,00	1	095510059
XL	520,00	1	095510061
XXL	520,00	1	095510063

9552J

casco jet by SUOMY



	€		
S	420,00	1	095520055
M	420,00	1	095520057
L	420,00	1	095520059
XL	420,00	1	095520061

9553J/L

casco jet light by SUOMY



	€		
S	160,00	1	095530055
M	160,00	1	095530057
L	160,00	1	095530059
XL	160,00	1	095530061

9544

trolley rigido formato cabina



9544 € 290,00 1 095440100

9545

trolley porta PC



9545 € 260,00 1 095450100

9557J

borsone sportivo in poliestere/PVC, 600D



58x27x30 cm € 55,00 1 095570011

9557N

borsa "Racing" realizzata in tessuto laminato PVC, totalmente impermeabile



80x35x35 cm € 77,00 1 095570001

9541

zaino sport porta PC in poliestere 600D/PVC. Inserti in 1680D e 420D/PU



43x39x16 cm € 60,00 1 095410000

Beta**95740**

guanti da lavoro



M	€ 27,00	1	095740202
L	€ 27,00	1	095740203
XL	€ 27,00	1	095740204
XXL	€ 27,00	1	095740205

9574B

guanti da lavoro



M	€ 27,00	1	095740102
L	€ 27,00	1	095740103
XL	€ 27,00	1	095740104
XXL	€ 27,00	1	095740105

9522C

cintura vintage in cuoio con fibbia in alluminio lunghezza 140 cm, accorciabile



9522C € 65,00 1 095220100

9525/ITA

cappellino regolabile 100% cotone, logo transfer in PVC 3D sul frontale e ricami diretti. Taglia unica



9525/ITA € 12,50 5 095250050

9525

cappellino, 100% cotone, taglia unica regolabile, ricamo diretto su visiera e laterale



9525 € 12,50 5 095251011

9525/N

cappellino, 100% cotone, taglia unica regolabile, ricamo diretto sul frontale, sui lati e sul retro, nero



9525/N € 12,50 5 095251021

9525/B

cappellino, 100% cotone, taglia unica regolabile, ricamo diretto sul frontale, sui lati e sul retro, bianco



9525/B € 12,50 5 095251031

9521

ombrello in nylon T210 con fusto in alluminio 3 sezioni, automatico



9521 € 22,00 1 095210000

95210/OB

ombrello "racing" in nylon 190T, diametro 150 cm



95210/OB € 33,00 1 095210011

9530

tuta realizzata in poliestere patch 100%, giacca foderata con mesh in poliestere 70 g



	€		
S	85,00	1	095300011
M	85,00	1	095300012
L	85,00	1	095300013
XL	85,00	1	095300014

9599CB

city bike Atala®, telaio in alluminio 49 cm, cambio Shimano® 6 velocità, freni V-brake®, cerchi in alluminio 28"



9599CB € 440,00 1 095990011

9598WAP

mountain bike Atala®, telaio in alluminio 48 cm con ammortizzatore frontale, cambio Shimano® 21 velocità, freni a disco meccanici, cerchi in alluminio 26



9598WAP € 590,00 1 095980000

Beta

9539C

casco bike per ciclismo, calotta esterna in policarbonato, interno in EPS nero alta densità, taglia regolabile 59-62

CE EN 1078



9539C	€ 87,00	1	095391000
-------	---------	---	-----------

9539

completo bike, maglia maniche corte in microfibra traspirante, zip lunga invisibile, tre tasche posteriori, elastico in silicone a fondo maglia salopette in lycra, elastico siliconato a fondo gamba, fondello antibatterico ad alta traspirabilità



S	€ 149,00	1	095390112
M	€ 149,00	1	095390113
L	€ 149,00	1	095390114
XL	€ 149,00	1	095390115
XXL	€ 149,00	1	095390116

9539G

giacca invernale in tessuto traspirante, garzato internamente, zip lunga, tre tasche posteriori, elastico in silicone a fondo giacca



S	€ 99,00	1	095390122
M	€ 99,00	1	095390123
L	€ 99,00	1	095390124
XL	€ 99,00	1	095390125
XXL	€ 99,00	1	095390126

9539P

salopette con mini zip anteriore, in tessuto super Roubaix e fondello Coolmax®



S	€ 98,00	1	095390032
M	€ 98,00	1	095390033
L	€ 98,00	1	095390034
XL	€ 98,00	1	095390035
XXL	€ 98,00	1	095390036

9539R

giubbino antivento senza maniche in tessuto accoppiato, zip lunga, tre tasche posteriori, elastico in silicone a fondo giubbino



S	€ 90,00	1	095390142
M	€ 90,00	1	095390143
L	€ 90,00	1	095390144
XL	€ 90,00	1	095390145
XXL	€ 90,00	1	095390146

9519M

maglia running maniche corte in tessuto microfibra traspirante



S	€ 55,00	1	095190201
M	€ 55,00	1	095190202
L	€ 55,00	1	095190203
XL	€ 55,00	1	095190204
XXL	€ 55,00	1	095190205

9519C

canotta running in tessuto microfibra traspirante



S	€ 45,00	1	095190211
M	€ 45,00	1	095190212
L	€ 45,00	1	095190213
XL	€ 45,00	1	095190214
XXL	€ 45,00	1	095190215

Beta

9519P

pantaloncini corti running in lycra



	€		
S	44,00	1	095190221
M	44,00	1	095190222
L	44,00	1	095190223
XL	44,00	1	095190224
XXL	44,00	1	095190225

9528

pallone calcio in TPU ed EVA 400 g



	€		
9528	17,00	1	095280000

95290/B

set 10 pettorine da calcio in mesh poliestere 100%, arancio/nero, bicolore reversibile



	€		
95290/B	145,00	1	095290007

9527

telo sport in spugna 400 g, 75x130 cm



	€		
9527	39,00	1	095271000

9526

set di 500 fiches, 13,5 g in valigetta di alluminio



	€		
9526	180,00	1	095260000

9524SC

garage Beta in miniatura per collezionisti



	€		
1:43	27,00	1	095240043
1:18	64,00	1	095240018

9547WSK

"Kinder Work Station", banco da lavoro con utensili per bambini a partire da 3 anni



	€		
9547WSK	84,00	1	095473801

9546

thermos in acciaio, capacità 0,45 litri



	€		
9546	15,00	1	095460100

9547

calcolatrice da tavolo



	€		
9547	12,00	1	095470000

9583

orologio radiocontrollato con stazione barometrica



	€		
9583	95,00	1	095830000

9594

orologio da parete dotato di termometro ed igrometro, diametro 26 cm



	€		
Ø cm 26	20,00	1	095940051



9586coltellino multiuso in acciaio inox,
10 funzioni

9586 € 11,50 1 095861001

9581

accendino, carica a benzina



9581 € 11,50 1 095811001

9577F1

tuta in twill di poliestere/cotone 65/35



S	110,00	1	095771001
M	110,00	1	095771002
L	110,00	1	095771003
XL	110,00	1	095771004
XXL	110,00	1	095771005
XXXL	110,00	1	095771006

9579C

camice in poliestere/cotone



M	43,00	1	095791002
L	43,00	1	095791003
XL	43,00	1	095791004

9575copertina a ventosa, in tessuto plastificato
con quattro ventose sul lato superiore

9575 € 28,00 1 095750001

9559striscione monofacciale in TNT,
modulo da 3x0,8 m o multipli

9559 € 21,50 1 095591001

9590

bandiera in nylon serigrafato



140x215 cm € 95,00 1 095900001

9582LE

insegna luminosa monofacciale da esterni



9582LE € 350,00 1 095820010

9582LI

insegna luminosa bifacciale da interni



9582LI € 425,00 1 095820050

9592S/50P

set 50 penne a sfera in plastica



9592S/50P € 30,00 1 095920201

9592P/P

penne a sfera personalizzate



9592P/P € 0,95 500 095920701

9596portabadge in poliestere con moschettone
in metallo e filo portatelefono

9596 € 4,00 10 095961001

9595M/10

10 portachiavi in alluminio con occhio, colore nero



9595M/10 € 21,00 1 095950070

9595S/10P

10 portachiavi in materiale plastico tipo EVA



9595S/10P € 9,50 1 095951001

9569

shopper in TNT, 38x42 cm, manici lunghi



9569 € 1,70 50 095691000

9569P

shopper in polietilene, con soffiotti laterali



9569 44x34 € 0,50 50 095691001

**9588S/10...**

set di 10 block notes



9588S/10A 21x29 cm	€ 22,00	1	095881001
9588S/10B 15x21 cm	€ 21,00	1	095881002
9588S/10C 10x15 cm	€ 13,00	1	095881003
9588S/10D 7,5x10,5 cm	€ 9,00	1	095880054

9588/10PI

set di 10 blocchetti per appunti con fogli adesivi



9588/10PI € 20,00 1 095880055

9591S/...

adesivi



* 9591 S/10A 60x14,6 cm	€ 11,00	1	095911001
* 9591 S/10B 38x10,7 cm	€ 7,00	1	095911002
° 9591 S/50C 26x7,8 cm	€ 13,00	1	095911003
° 9591 S/50D 13x3,9 cm	€ 6,00	1	095911004

* I prezzi indicati sono relativi a 10 pezzi
° I prezzi indicati sono relativi a 50 pezzi

9589A/36

confezione da 36 rotoli di nastro adesivo per imballo, logo Beta, avana



9589A/36 € 93,00 1 095890035

9589B/36

confezione da 36 rotoli di nastro adesivo per imballo, logo Beta, bianco



9589B/36 € 93,00 1 095890036



SERVIZIO DI TARATURA DINAMOMETRIA

Beta Utensili SpA dispone di attrezzature certificate **Accredia (SIT)** per la taratura di chiavi dinamometriche fino a **3000 Nm**, in conformità alla **norma UNI EN ISO 6789**.

Presso il **Laboratorio Beta** è possibile eseguire la calibrazione dei seguenti articoli:



Chiavi a slittamento, a disinnesto o scatto



Chiavi non graduate



Giraviti dinamometrici



Chiavi a lettura



Chiavi digitali



Dynatester

Le calibrazioni sono eseguite in senso destrorso.

Per le chiavi dinamometriche digitali e i giraviti dinamometrici è possibile richiedere la certificazione destrorsa, sinistrorsa o entrambe.

La norma prevede un controllo su tre punti (20%, 60% e 100% della capacità massima della chiave) con cinque campionamenti.

Per le chiavi pretarate è previsto un solo punto di controllo (richiesto dal cliente) con cinque campionamenti.

I Dynatester vengono certificati presso un laboratorio esterno accreditato UKAS, riconosciuto a livello internazionale. Per la calibrazione sono previsti 3 campionamenti su più punti, in un senso di rotazione o in entrambi.

Il certificato di calibrazione viene rilasciato direttamente dal Laboratorio Beta.

Il certificato di taratura viene rilasciato da un laboratorio esterno, Accredia (SIT).

La validità dei certificati è pari a 5.000 cicli o a un anno dal primo utilizzo, secondo quanto previsto dalla norma UNI EN ISO 6789.

<small>BETA UTENSILI SPA con sede unica - Capitale Sociale Eur. 10.000.000 i.r. Via A. Volta 18 - 20045 Sesto San Giovanni - Milano Tel. 02/6037711 - Telefax 02/60377142 Internet: www.beta-utensili.com - E-mail: info@beta-utensili.it P.I.E.A. 040 10564570 - R. Min. 540014814 Reg. Imp. Monza e Brianza n. 02627120127 Partita IVA 02602102667 - Codice Fiscale 02607120127 - PAISE 070820000002666 Stabilimento di Castiglione d'Adda (LO) - Via Incomata, 35 - Tel. 03779000069 Stabilimento di Salsomaggiore (AG) - C.da S. Nicola - Zona Industriale - Tel. 026425041</small>																																																					
CERTIFICATE OF CALIBRATION n° 2044																																																					
<small>Modello: 684 N (8000000005) SERIE NO: Serial n°: 2003274897 CAPACITÀ MAX Maximum capacity: 40 COLLAUDATORE Inspector: C.M.</small>		<small>UNITÀ DI MISURA Unit: Nm TEMP. AMBIENTE Ambient Temperature: 21 °C</small>																																																			
<table border="1"> <thead> <tr> <th>VALORE SELEZIONATO</th> <th colspan="2">TOLLERANZE</th> <th colspan="5">VALORI RISCONTRATI</th> </tr> <tr> <th></th> <th>INF.</th> <th>SUP.</th> <th colspan="5">Actual Readings</th> </tr> <tr> <th>Set Torque</th> <th>Min</th> <th>Max</th> <th></th> <th></th> <th></th> <th></th> <th></th> </tr> </thead> <tbody> <tr> <td>12,00</td> <td>11,54</td> <td>12,50</td> <td>12,22</td> <td>12,22</td> <td>12,21</td> <td>12,19</td> <td>12,19</td> </tr> <tr> <td>36,00</td> <td>34,62</td> <td>37,50</td> <td>35,21</td> <td>35,22</td> <td>35,15</td> <td>35,36</td> <td>35,15</td> </tr> <tr> <td>60,00</td> <td>57,69</td> <td>62,50</td> <td>59,17</td> <td>59,10</td> <td>59,05</td> <td>59,12</td> <td>59,16</td> </tr> </tbody> </table>	VALORE SELEZIONATO	TOLLERANZE		VALORI RISCONTRATI						INF.	SUP.	Actual Readings					Set Torque	Min	Max						12,00	11,54	12,50	12,22	12,22	12,21	12,19	12,19	36,00	34,62	37,50	35,21	35,22	35,15	35,36	35,15	60,00	57,69	62,50	59,17	59,10	59,05	59,12	59,16					
VALORE SELEZIONATO	TOLLERANZE		VALORI RISCONTRATI																																																		
	INF.	SUP.	Actual Readings																																																		
Set Torque	Min	Max																																																			
12,00	11,54	12,50	12,22	12,22	12,21	12,19	12,19																																														
36,00	34,62	37,50	35,21	35,22	35,15	35,36	35,15																																														
60,00	57,69	62,50	59,17	59,10	59,05	59,12	59,16																																														
<small>LA TOLLERANZA INDICATA E LO STRUMENTO USATO PER IL CONTROLLO The limits shown and the test equipment used for this calibration SONO CONFORMI ALLA NORMATIVA Comply with the requirement of: ISO 6789 : 2003 L'INCERTEZZA DELLO STRUMENTO DI PROVA, A 20°C È: ± 1 % K=2 The uncertainty of the test equipment at 20°C is ± 1 % K=2</small>																																																					
<small>LO STRUMENTO DI PROVA USATO NEL CORSO DELLA SUDETTA CALIBRAZIONE HA TRACCIABILITÀ INTERNAZIONALE The test equipment used in the performance of the above calibration has international through: TESTER MODELLO Tester model: Torque Wrench Analyzer SERIE NO: Serial No: 75369 CERT. ACCREDITA NO: ACCREDITA cert No: CE-TM-0251-2012 LABORATORIO NO: Laboratory No: 051</small>																																																					
						<small>DATA DEL CONTROLLO Date of calibration 15/05/2013 RESPONSABILE QUALITÀ/ Quality Manager L. Creghis</small>																																															

Per usufruire di questo servizio rivolgiti al tuo rivenditore di fiducia

ARTICOLI ELIMINATI – ARTICOLI SOSTITUTIVI/CONSIGLIATI

		ARTICOLO ELIMINATO	
		ARTICOLO SOSTITUTIVO	
		ARTICOLO CONSIGLIATO	
357	003570001	357 F3	003570100
392 A	003920001	392 C	003920100
392 A/RG	003920051		
434 ASFNR6	004340301		
434 ASFNR8	004340302		
434 ASFNR10	004340303		
434 ASFNR12	004340304		
434 ASF1/4	004340305	433 ASF1/4	004330301
434 ASF5/16	004340306	433 ASF5/16	004330302
434 ASF3/8	004340307	433 ASF3/8	004330303
434 ASF7/16	004340308	433 ASF7/16	004330304
434 ASF1/2	004340309	433 ASF1/2	004330305
434 ASF9/16	004340310	433 ASF9/16	004330306
434 ASF5/8	004340311	433 ASF5/8	004330307
434 ASF3/4	004340312	433 ASF3/4	004330308
434 ASF7/8	004340313	433 ASF7/8	004330309
434 ASF1"	004340314	433 ASF1"	004330310
434 ASG1/8	004340401	433 ASG1/8	004330401
434 ASG1/4	004340402	433 ASG1/4	004330402
434 ASG3/8	004340403	433 ASG3/8	004330403
434 ASG1/2	004340404	433 ASG1/2	004330405
434 ASG5/8	004340405		
434 ASG3/4	004340406	433 ASG3/4	004330408
434 ASG7/8	004340407		
434 ASG1"	004340408	433 ASG1"	004330410
442 ASG1/8	004420255	440 ASG1/8	004400255
442 ASG1/4	004420256	440 ASG1/4	004400256
442 ASG3/8	004420257	440 ASG3/8	004400257
442 ASG1/2	004420258	440 ASG1/2	004400259
442 ASG5/8	004420259		
442 ASG3/4	004420260	440 ASG3/4	004400260
442 ASG7/8	004420261		
442 ASG1"	004420262	440 ASG1"	004400261
604 /5	006040001	604B /5	006040015
667 /C3	006670240	667 /40	006670140
855	008550001	855 P	008550010
861 /C26	008610950		
900 /C30	009000958	860 /C38P	008600878
920 TX/LS4	009200544	920 TX/L SB6	009200543
960 I	009600220		
980	009800003		
1080 140	010800004	1080 D15	010800015
1080 160	010800006	1080 D15	010800015
1081 S140	010810014	1082 140	010820004
1081 S160	010810016	1082 160	010820006
1088 140	010880004	1088 160	010880006
1088 BM140	010880034	1088 BM160	010880036
1151 S160	011510016	1150 160	011500006
1151 S180	011510018	1150 180	011500008
1151 S200	011510020	1150 200	011500010
1227 2,5X60	012270010	1257LP 3,0	012570030
1227 3X75	012270020	1257LP 3,5	012570035
1227 3X100	012270030		
1228 3X75	012280030	1257PH 0	012570063
1290 3X125	012900015	1290 3X100	012900012
1290 3,5X125	012900024	1290 3,5X100	012900021
1290 4X75	012900027	1290 3,5X75	012900018
1290 5,5X200	012900045	1290 5,5X150	012900042
1290 6,5X200	012900054	1290 6,5X150	012900051
1290 10X150	012900063	1290 10X200	012900066
1290 E 5,5X125	012900153		
1290 E 6,5X150	012900156	1260 E 6,5	012600156
1290 E 10X175	012900159	1260 E 10	012600159
1290 E 12X200	012900162	1260 E 12	012600162
1290 /S9	012900309	1290 /S9X	012900319
1292 4,5X150	012920015	1292 4,5X120	012920012
1292 6X200	012920023	1292 6X150	012920021
1292 E 6X150	012920153	1262 PH2 E6	012620153

1292 E 8X175	012920156	1262 PH3 E8	012620156
1292 E 10X200	012920159	1262 PH4 E10	012620159
1293 /S8PZ	012930205	1299 PZ/S6	012990306
1293 /S8H	012930209	1293 /S7	012930207
1293 /D11	012930405	1293 /S10	012930201
1293 /D7	012930407	1299 PZ/S6	012990306
1293 /D8H	012930411	1293 /S7	012930207
1294 5X150	012940021	1294 6,5X150	012940027
1294 5X200	012940024	1294 6,5X150	012940027
1294 8X150	012940030	1294 6,5X150	012940027
1294 L 2,5X200	012940203	1294 L 3X300	012940206
1294 L 5X300	012940212	1294 L 5X400	012940215
1454	014540001		
1461 /C3	014610030	1461 /C3B	014610031
1461 /C5	014610050	1461 /C5G	014610052
1461 /C5A	014610051		
1461 /C6	014610060	1461 /C6G	014610062
1461 /C7	014610070	1461 /C7B	014610071
1461 /C8	014610080	1461 /C8G	014610082
1461 /C9	014610090	1461 /C9B	014610091
1461 /C10	014610100	1461 /C18B	014610181
1461 /C11	014610110	1461 /C11G	014610112
1461 /C12	014610120	1461 /C12G	014610122
1461 R6/K3	014610601		
1472 FS	014720110	1472 FC	014720090
1476 B/1	014760020		
1479 TF	014790005		
1493 67-L14	014930204		
1530 B	015300011		
1530 /3	015300030	1530 /C5	015300300
1530 /4	015300040	1530 /C5	015300300
1531 /3	015310001	1530 /C5	015300300
1531 /4	015310002	1530 /C5	015300300
1531 /5	015310003	1530 /C5	015300300
1531 B	015310201		
1555 M	015550010		
1695	016950000		
1739 A	017390101	1739 B	017390151
1759 HD/2	017590062	1759 HD/3	017590063
1778 C	017780020	1778 W	017780025
1838 G	018380200	1838 LED/120	018380250
1842 BM	018420101	1842 XBM	018420201
1842 ABM	018420111	1842 XABM	018420211
1846 BM	018460101	1846 XBM	018460201
1846 ABM	018460111	1846 XABM	018460211
1846 R/BM	018460131	1846 R/XBM	018460231
1847	018470001	1847 P	018470010
1927 MCD	019270027	1927 MDA	019270028
1936 /5P	019360035	1936 /5A	019360025
1946 B	019460007	1946C 7,8	019460008
2011 ET/A	020110117	2011 ET/A	020110127
2011 ET/B	020110119	2011 ET/B	020110129
2029 ET/B	020290211	2029 ET/B	020290221
2029 BG-MQ	020290251	2029 BG-MQ	020290261
2032 ET/A	020320107	2032 ET/A	020320117
2032T ET/A	020320207	2032T ET/A	020320227
2033 ET/B	020330107	2033 ET/B	020330117
2034 ET/A	020340104	2034 ET/A	020340114
2036 ET/B	020360113	2036 ET/B	020360123
2055	020550200	2055 HB	020550210
2300 ST-O/VG1T	023000681	2300 ST-O/VG1M	023000685
2300 ST-G/VG1T	023000682	2300 ST-G/VG1M	023000686
2300 ST-R/VG1T	023000683	2300 ST-R/VG1M	023000687
2400 SL-O/VI3	024002404		
2400 SL-G/VI3	024002405		
2400 SL-R/VI3	024002406		
2400 SL-O/VG4T	024002427		
2400 SL-G/VG4T	024002428		
2400 SL-R/VG4T	024002429		
2400 S5-O/VG3	024002524		
2400 S5-G/VG3	024002525		
2400 S5-R/VG3	024002526		

2400 S6-O/VG3	024002634		
2400 S6-G/VG3	024002635		
2400 S6-R/VG3	024002636		
2400 S7-O/VI2T	024002704		
2400 S7-G/VI2T	024002705		
2400 S7-R/VI2T	024002706		
2400 SA7-O/VI2T	024002707		
2400 SA7-G/VI2T	024002708		
2400 SA7-R/VI2T	024002709		
2400 ST-O/VI3	024002714		
2400 ST-G/VI3	024002715		
2400 ST-R/VI3	024002716		
2400 SA7-O/VI3	024002717		
2400 SA7-G/VI3	024002718		
2400 SA7-R/VI3	024002719		
2400 S7-O/VG1T	024002724	2400 S7-O/VG1M	024002741
2400 S7-G/VG1T	024002725	2400 S7-G/VG1M	024002742
2400 S7-R/VG1T	024002726	2400 S7-R/VG1M	024002743
2400 SA7-O/VG1T	024002727	2400 SA7-O/VG1M	024002754
2400 SA7-G/VG1T	024002728	2400 SA7-G/VG1M	024002755
2400 SA7-R/VG1T	024002729	2400 SA7-R/VG1M	024002756
2400 S8-O/VI2T	024002804	2400 S8-O/VI2T	024002807
2400 S8-G/VI2T	024002805	2400 S8-G/VI2T	024002808
2400 S8-R/VI2T	024002806	2400 S8-R/VI2T	024002809
2424 T152	024240152	2424 T155	024240155
2500 /VG0	025000080		
2500 /VG2	025000083	2500 /VG2	025000084
2800 O/VI1	028000314		
2800 G/VI1	028000315		
2800 R/VI1	028000316		
2800 O/VG1	028000334		
2800 G/VG1	028000335		
2800 R/VG1	028000336		
2800 O/VG2	028000344	2800 O/VG2T	028000347
2800 G/VG2	028000345	2800 G/VG2T	028000348
2800 R/VG2	028000346	2800 R/VG2T	028000349
C30	030000001	C30 S	030000100
3000 /VI1	030000081		
3000 /VI3	030000092	3000 /VI3T	030000093
3000 /VG3	030000095	3000 /VG3T	030000097
3800 O/U2	038000065	3800 O/U2T	038000068
3800 G/U2	038000066	3800 G/U2T	038000069
3800 R/U2	038000067	3800 R/U2T	038000070
C38 A-O	038000301	C38 O	038000001
C38 A-R	038000302	C38 R	038000002
C38 A-G	038000303	C38 G	038000003
3900 O-7/VI2T	039000134		
3900 G-7/VI2T	039000135		
3900 R-7/VI2T	039000136		
3900 O-7/VG1T	039000144	3900 O-7/VG1M	039000147
3900 G-7/VG1T	039000145	3900 G-7/VG1M	039000148
3900 R-7/VG1T	039000146	3900 R-7/VG1M	039000149
3900 O-7/VG4T	039000167		
3900 G-7/VG4T	039000168		
3900 R-7/VG4T	039000169		
3900 O-8/VI2T	039000174	3900 O-8/VI2T	039000177
3900 G-8/VI2T	039000175	3900 G-8/VI2T	039000178
3900 R-8/VI2T	039000176	3900 R-8/VI2T	039000179
3939 SM-O/VG1T	039390201		
3939 SM-G/VG1T	039390202		
3939 SM-R/VG1T	039390203		
3939 MD-O/VG1T	039390251		
3939 MD-G/VG1T	039390252		
3939 MD-R/VG1T	039390253		
4100S /M2	041000084	4100S /SBK	041000104
4100H /M2	041000094	4100H /SBK	041000114
5904 VI2T	059040162	5904 VI2T	059040163
5904 VI3	059040166	5904 VI3T	059040167
5904 VG1/T	059040194	5904 VG1/M	059040197
5904 VG4/T	059040195		
5905 VG/2	059050143	5905 VG/2	059050144
5905 VG/0	059050162		

ARTICOLI ELIMINATI – ARTICOLI SOSTITUTIVI/CONSIGLIATI

	ARTICOLO ELIMINATO
	ARTICOLO SOSTITUTIVO
	ARTICOLO CONSIGLIATO

5908 VI/1	059080100		
5908 VG/1	059080110		
5908 VG/2	059080115	5908 VG/2T	059080117
5910 VI/3	059100052	5910 VI/3T	059100062
5910 VG/3	059100057	5910 VG/3T	059100067
5938 U2	059380061	5938 U2T	059380062
5940 M2	059400061	5940 SBK	059400071
5980 BG/MQ	059800224	5980 MQ	059800254
5980 ET/A	059800231	5980 ET/A	059800261
5980 ET/B	059800233	5980 ET/B	059800263
7195 MA	071950003	7195 A	071950004
7244B 35	072440235	7243C 35	072430335
7244B 36	072440236	7243C 36	072430336
7244B 37	072440237	7243C 37	072430337
7244B 38	072440238	7243C 38	072430338
7244B 39	072440239	7243C 39	072430339
7244B 40	072440240	7243C 40	072430340
7244B 41	072440241	7243C 41	072430341
7244B 42	072440242	7243C 42	072430342
7244B 43	072440243	7243C 43	072430343
7244B 44	072440244	7243C 44	072430344
7244B 45	072440245	7243C 45	072430345
7244B 46	072440246	7243C 46	072430346
7244B 47	072440247	7243C 47	072430347
7244B 48	072440248	7243C 48	072430348
7250NK 38	072500138	7250NKK 38	072500238
7250NK 39	072500139	7250NKK 39	072500239
7250NK 40	072500140	7250NKK 40	072500240
7250NK 41	072500141	7250NKK 41	072500241
7250NK 42	072500142	7250NKK 42	072500242
7250NK 43	072500143	7250NKK 43	072500243
7250NK 44	072500144	7250NKK 44	072500244
7250NK 45	072500145	7250NKK 45	072500245
7250NK 46	072500146	7250NKK 46	072500246
7250NK 47	072500147	7250NKK 47	072500247
7251NK 38	072510138	7251NKK 38	072510238
7251NK 39	072510139	7251NKK 39	072510239
7251NK 40	072510140	7251NKK 40	072510240
7251NK 41	072510141	7251NKK 41	072510241
7251NK 42	072510142	7251NKK 42	072510242
7251NK 43	072510143	7251NKK 43	072510243
7251NK 44	072510144	7251NKK 44	072510244
7251NK 45	072510145	7251NKK 45	072510245
7251NK 46	072510146	7251NKK 46	072510246
7251NK 47	072510147	7251NKK 47	072510247
7256NA 38	072560138	7254NA 38	072540138
7256NA 39	072560139	7254NA 39	072540139
7256NA 40	072560140	7254NA 40	072540140
7256NA 41	072560141	7254NA 41	072540141
7256NA 42	072560142	7254NA 42	072540142
7256NA 43	072560143	7254NA 43	072540143
7256NA 44	072560144	7254NA 44	072540144
7256NA 45	072560145	7254NA 45	072540145
7256NA 46	072560146	7254NA 46	072540146
7256NA 47	072560147	7254NA 47	072540147
7257NA 38	072570138	7255NA 38	072550138
7257NA 39	072570139	7255NA 39	072550139
7257NA 40	072570140	7255NA 40	072550140
7257NA 41	072570141	7255NA 41	072550141
7257NA 42	072570142	7255NA 42	072550142
7257NA 43	072570143	7255NA 43	072550143
7257NA 44	072570144	7255NA 44	072550144
7257NA 45	072570145	7255NA 45	072550145
7257NA 46	072570146	7255NA 46	072550146
7257NA 47	072570147	7255NA 47	072550147
7263NK 38	072630038	7263RK 38	072630138
7263NK 39	072630039	7263RK 39	072630139
7263NK 40	072630040	7263RK 40	072630140

7263NK 41	072630041	7263RK 41	072630141
7263NK 42	072630042	7263RK 42	072630142
7263NK 43	072630043	7263RK 43	072630143
7263NK 44	072630044	7263RK 44	072630144
7263NK 45	072630045	7263RK 45	072630145
7263NK 46	072630046	7263RK 46	072630146
7263NK 47	072630047	7263RK 47	072630147
7264NK 38	072640038	7264RK 38	072640138
7264NK 39	072640039	7264RK 39	072640139
7264NK 40	072640040	7264RK 40	072640140
7264NK 41	072640041	7264RK 41	072640141
7264NK 42	072640042	7264RK 42	072640142
7264NK 43	072640043	7264RK 43	072640143
7264NK 44	072640044	7264RK 44	072640144
7264NK 45	072640045	7264RK 45	072640145
7264NK 46	072640046	7264RK 46	072640146
7264NK 47	072640047	7264RK 47	072640147
7300AKK 36	073000136	7300BKK 36	073000236
7300AKK 37	073000137	7300BKK 37	073000237
7300AKK 38	073000138	7300BKK 38	073000238
7300AKK 39	073000139	7300BKK 39	073000239
7300AKK 40	073000140	7300BKK 40	073000240
7300AKK 41	073000141	7300BKK 41	073000241
7300AKK 42	073000142	7300BKK 42	073000242
7300AKK 43	073000143	7300BKK 43	073000243
7300AKK 44	073000144	7300BKK 44	073000244
7300AKK 45	073000145	7300BKK 45	073000245
7300AKK 46	073000146	7300BKK 46	073000246
7300AKK 47	073000147	7300BKK 47	073000247
7300AKK 48	073000148	7300BKK 48	073000248
7300CKK 36	073000336		
7300CKK 37	073000337		
7300CKK 38	073000338		
7300CKK 39	073000339		
7300CKK 40	073000340		
7300CKK 41	073000341		
7300CKK 42	073000342		
7300CKK 43	073000343		
7300CKK 44	073000344		
7300CKK 45	073000345		
7300CKK 46	073000346		
7300CKK 47	073000347		
7300CKK 48	073000348		
7300A 36	073000436	7300B 36	073000536
7300A 37	073000437	7300B 37	073000537
7300A 38	073000438	7300B 38	073000538
7300A 39	073000439	7300B 39	073000539
7300A 40	073000440	7300B 40	073000540
7300A 41	073000441	7300B 41	073000541
7300A 42	073000442	7300B 42	073000542
7300A 43	073000443	7300B 43	073000543
7300A 44	073000444	7300B 44	073000544
7300A 45	073000445	7300B 45	073000545
7300A 46	073000446	7300B 46	073000546
7300A 47	073000447	7300B 47	073000547
7300A 48	073000448	7300B 48	073000548
7302AKK 36	073020336		
7302AKK 37	073020337		
7302AKK 38	073020338		
7302AKK 39	073020339		
7302AKK 40	073020340		
7302AKK 41	073020341		
7302AKK 42	073020342		
7302AKK 43	073020343		
7302AKK 44	073020344		
7302AKK 45	073020345		
7302AKK 46	073020346		
7302AKK 47	073020347		
7302AKK 48	073020348		
7302A 36	073020436		
7302A 37	073020437		
7302A 38	073020438		

7302A 39	073020439		
7302A 40	073020440		
7302A 41	073020441		
7302A 42	073020442		
7302A 43	073020443		
7302A 44	073020444		
7302A 45	073020445		
7302A 46	073020446		
7302A 47	073020447		
7302A 48	073020448		
7316KKB 35	073160335	7313KKC 35	073130535
7316KKB 36	073160336	7313KKC 36	073130536
7316KKB 37	073160337	7313KKC 37	073130537
7316KKB 38	073160338	7313KKC 38	073130538
7316KKB 39	073160339	7313KKC 39	073130539
7316KKB 40	073160340	7313KKC 40	073130540
7316KKB 41	073160341	7313KKC 41	073130541
7316KKB 42	073160342	7313KKC 42	073130542
7316KKB 43	073160343	7313KKC 43	073130543
7316KKB 44	073160344	7313KKC 44	073130544
7316KKB 45	073160345	7313KKC 45	073130545
7316KKB 46	073160346	7313KKC 46	073130546
7316KKB 47	073160347	7313KKC 47	073130547
7316KKB 48	073160348	7313KKC 48	073130548
7323KK 35	073230135		
7323KK 36	073230136		
7323KK 37	073230137		
7323KK 38	073230138		
7323KK 39	073230139		
7323KK 40	073230140		
7323KK 41	073230141		
7323KK 42	073230142		
7323KK 43	073230143		
7323KK 44	073230144		
7323KK 45	073230145		
7323KK 46	073230146		
7323KK 47	073230147		
7323KK 48	073230148		
7325KK 35	073250135		
7325KK 36	073250136		
7325KK 37	073250137		
7325KK 38	073250138		
7325KK 39	073250139		
7325KK 40	073250140		
7325KK 41	073250141		
7325KK 42	073250142		
7325KK 43	073250143		
7325KK 44	073250144		
7325KK 45	073250145		
7325KK 46	073250146		
7325KK 47	073250147		
7325KK 48	073250148		
7328 38	073280038	7328EA 38	073280538
7328 39	073280039	7328EA 39	073280539
7328 40	073280040	7328EA 40	073280540
7328 41	073280041	7328EA 41	073280541
7328 42	073280042	7328EA 42	073280542
7328 43	073280043	7328EA 43	073280543
7328 44	073280044	7328EA 44	073280544
7328 45	073280045	7328EA 45	073280545
7328 46	073280046	7328EA 46	073280546
7328 47	073280047	7328EA 47	073280547
7328 N38	073280238	7328EN 38	073280738
7328 N39	073280239	7328EN 39	073280739
7328 N40	073280240	7328EN 40	073280740
7328 N41	073280241	7328EN 41	073280741
7328 N42	073280242	7328EN 42	073280742
7328 N43	073280243	7328EN 43	073280743
7328 N44	073280244	7328EN 44	073280744
7328 N45	073280245	7328EN 45	073280745
7328 N46	073280246	7328EN 46	073280746
7328 N47	073280247	7328EN 47	073280747

ARTICOLI ELIMINATI – ARTICOLI SOSTITUTIVI/CONSIGLIATI

		ARTICOLO ELIMINATO	
		ARTICOLO SOSTITUTIVO	
		ARTICOLO CONSIGLIATO	
7329NV 38	073290438	7330NV 38	073300438
7329NV 39	073290439	7330NV 39	073300439
7329NV 40	073290440	7330NV 40	073300440
7329NV 41	073290441	7330NV 41	073300441
7329NV 42	073290442	7330NV 42	073300442
7329NV 43	073290443	7330NV 43	073300443
7329NV 44	073290444	7330NV 44	073300444
7329NV 45	073290445	7330NV 45	073300445
7329NV 46	073290446	7330NV 46	073300446
7329NV 47	073290447	7330NV 47	073300447
7329NV 48	073290448	7330NV 48	073300448
7333 36	073330136		
7333 37	073330137		
7333 38	073330138		
7333 39	073330139		
7333 40	073330140		
7333 41	073330141		
7333 42	073330142		
7333 43	073330143		
7333 44	073330144		
7333 45	073330145		
7333 46	073330146		
7333 47	073330147		
7333 48	073330148		
7398 C36	073980436	7398ST 36	073981036
7398 C37	073980437	7398ST 37	073981037
7398 C38	073980438	7398ST 38	073981038
7398 C39	073980439	7398ST 39	073981039
7398 C40	073980440	7398ST 40	073981040
7398 C41	073980441	7398ST 41	073981041
7398 C42	073980442	7398ST 42	073981042
7398 C43	073980443	7398ST 43	073981043
7398 C44	073980444	7398ST 44	073981044
7398 C45	073980445	7398ST 45	073981045
7398 C46	073980446	7398ST 46	073981046
7398 C47	073980447	7398ST 47	073981047
7398 C48	073980448	7398ST 48	073981048
7398 FT36	073980736	7398CX 36	073980936
7398 FT37	073980737	7398CX 37	073980937
7398 FT38	073980738	7398CX 38	073980938
7398 FT39	073980739	7398CX 39	073980939
7398 FT40	073980740	7398CX 40	073980940
7398 FT41	073980741	7398CX 41	073980941
7398 FT42	073980742	7398CX 42	073980942
7398 FT43	073980743	7398CX 43	073980943
7398 FT44	073980744	7398CX 44	073980944
7398 FT45	073980745	7398CX 45	073980945
7398 FT46	073980746	7398CX 46	073980946
7398 FT47	073980747	7398CX 47	073980947
7398 FT48	073980748	7398CX 48	073980948
7411 S	074110001	7410 S	074100001
7411 M	074110002	7410 M	074100002
7411 L	074110003	7410 L	074100003
7411 XL	074110004	7410 XL	074100004
7412 S	074120001	7410 S	074100001
7412 M	074120002	7410 M	074100002
7412 L	074120003	7410 L	074100003
7412 XL	074120004	7410 XL	074100004
7414 S	074140001	7410 S	074100001
7414 M	074140002	7410 M	074100002
7414 L	074140003	7410 L	074100003
7414 XL	074140004	7410 XL	074100004
7543BL /XS	075430000		
7543BL /S	075430001		
7543BL /M	075430002		
7543BL /L	075430003		
7543BL /XL	075430004		
7543BL /XXL	075430005		

7543BL /XXXL	075430006		
7543B /XS	075430100		
7543B /S	075430101		
7543B /M	075430102		
7543B /L	075430103		
7543B /XL	075430104		
7543B /XXL	075430105		
7543B /XXXL	075430106		
7549BL /XS	075490000	7547BL XS	075470000
7549BL /S	075490001	7547BL S	075470001
7549BL /M	075490002	7547BL M	075470002
7549BL /L	075490003	7547BL L	075470003
7549BL /XL	075490004	7547BL XL	075470004
7549BL /XXL	075490005	7547BL XXL	075470005
7549BL /XXXL	075490006	7547BL XXXL	075470006
7549G /XS	075490100	7547G XS	075470100
7549G /S	075490101	7547G S	075470101
7549G /M	075490102	7547G M	075470102
7549G /L	075490103	7547G L	075470103
7549G /XL	075490104	7547G XL	075470104
7549G /XXL	075490105	7547G XXL	075470105
7549G /XXXL	075490106	7547G XXXL	075470106
7619N /S	076190001		
7619N /M	076190002		
7619N /L	076190003		
7619N /XL	076190004		
7619N /XXL	076190005		
7619N /XXXL	076190006		
7621 BLU/XS	076210100	7622G XS	076220000
7621 BLU/S	076210101	7622G S	076220001
7621 BLU/M	076210102	7622G M	076220002
7621 BLU/L	076210103	7622G L	076220003
7621 BLU/XL	076210104	7622G XL	076220004
7621 BLU/XXL	076210105	7622G XXL	076220005
7621 BLU/XXXL	076210106	7622G XXXL	076220006
7631 BLU/XS	076310100	7632G XS	076320000
7631 BLU/S	076310101	7632G S	076320001
7631 BLU/M	076310102	7632G M	076320002
7631 BLU/L	076310103	7632G L	076320003
7631 BLU/XL	076310104	7632G XL	076320004
7631 BLU/XXL	076310105	7632G XXL	076320005
7631 BLU/XXXL	076310106	7632G XXXL	076320006
7640 D-GREY/XS	076400100	7641G XS	076410100
7640 D-GREY/S	076400101	7641G S	076410101
7640 D-GREY/M	076400102	7641G M	076410102
7640 D-GREY/L	076400103	7641G L	076410103
7640 D-GREY/XL	076400104	7641G XL	076410104
7640 D-GREY/XXL	076400105	7641G XXL	076410105
7640 D-GREY/XXXL	076400106	7641G XXXL	076410106
7640 D-BLUE/XS	076400120	7641BL XS	076410000
7640 D-BLUE/S	076400121	7641BL S	076410001
7640 D-BLUE/M	076400122	7641BL M	076410002
7640 D-BLUE/L	076400123	7641BL L	076410003
7640 D-BLUE/XL	076400124	7641BL XL	076410004
7640 D-BLUE/XXL	076400125	7641BL XXL	076410005
7640 D-BLUE/XXXL	076400126	7641BL XXXL	076410006
7680N /S	076800001	7682BL S	076820001
7680N /M	076800002	7682BL M	076820002
7680N /L	076800003	7682BL L	076820003
7680N /XL	076800004	7682BL XL	076820004
7680N /XXL	076800005	7682BL XXL	076820005
7680N /XXXL	076800006	7682BL XXXL	076820006
7695BL /S	076950001	7780N S	077800001
7695BL /M	076950002	7780N M	077800002
7695BL /L	076950003	7780N L	077800003
7695BL /XL	076950004	7780N XL	077800004
7695BL /XXL	076950005	7780N XXL	077800005
7695BL /XXXL	076950006	7780N XXXL	077800006
7908 E/M	079080902		
7908 E/XL	079080904		
7917Y /XS	079170100		
7917Y /S	079170101		

7917Y /M	079170102		
7917Y /L	079170103		
7917Y /XL	079170104		
7917Y /XXL	079170105		
7917Y /XXXL	079170106		
7919Y /XS	079190100		
7919Y /S	079190101		
7919Y /M	079190102		
7919Y /L	079190103		
7919Y /XL	079190104		
7919Y /XXL	079190105		
7919Y /XXXL	079190106		
8020 2-3K	080200103	8020 2-3	080200003
8020 4K	080200104	8020 4	080200004
8020 5K	080200105	8020 5	080200005
8020 6K	080200106	8020 6	080200006
8020 8K	080200108	8020 8	080200008
8020 10K	080200110	8020 10	080200010
8020 12K	080200112	8020 12	080200012
8020 14K	080200114	8020 14	080200014
8020 16K	080200116	8020 16	080200016
8020 18K	080200118	8020 18	080200018
8020 20K	080200120	8020 20	080200020
8020 22K	080200122	8020 22	080200022
8020 25K	080200125	8020 25	080200025
8020 28K	080200128	8020 28	080200028
8041E AL ZM8	080410108	8040EZ 8	080400408
8041E AL ZM10	080410110	8040EZ 10	080400410
8041E AL ZM12	080410112	8040EZ 12	080400412
8041E AL ZM14	080410114	8040EZ 14	080400414
8041E AL ZM16	080410116	8040EZ 16	080400416
8041E AL ZM18	080410118	8040EZ 18	080400418
8041E AL ZM20	080410120	8040EZ 20	080400420
8041E AL ZM22	080410122	8040EZ 22	080400422
8041E AL ZM24	080410124	8040EZ 24	080400424
8043E AL ZM8	080430108	8042EZ 8	080420408
8043E AL ZM10	080430110	8042EZ 10	080420410
8043E AL ZM12	080430112	8042EZ 12	080420412
8043E AL ZM14	080430114	8042EZ 14	080420414
8043E AL ZM16	080430116	8042EZ 16	080420416
8043E AL ZM18	080430118	8042EZ 18	080420418
8043E AL ZM20	080430120	8042EZ 20	080420420
8043E AL ZM22	080430122	8042EZ 22	080420422
8043E AL ZM24	080430124	8042EZ 24	080420424
8044 M18	080440018		
8044 M22	080440022		
8044 M27	080440027		
8044 M36	080440036		
8044 M42	080440042		
8050 D18	080500962		
8050 D19	080500963		
8050 D20	080500964		
8050 D21	080500965		
8069 1000	080690010		
8069 2000	080690020		
8069 3000	080690030		
8069 4000	080690040		
8069 5000	080690050		
8069 6000	080690060		
8069 8000	080690080		
9506 S	095060001		
9506 M	095060002		
9506 L	095060003		
9506 XL	095060004		
9506 XXL	095060005		



Abbigliamento da lavoro	354÷369
Accessori per funi Robur	370÷389
Accessori portautensili per armadietti, cassette e pareti	306÷308
Armadietti portautensili	236, 238-239
Artigli prensili flessibili	153
Aspiratore per liquidi	172
Assortimenti di utensili	248÷290
Assortimenti utensili in termoformato	291÷306
Attrezzi per il ripristino delle filettature	37
Avvolgicavo automatici con portalamпада	170-171
Avvolgitubo automatici per aria/acqua	200
Banchi da lavoro	240÷247
Barre dinamometriche	47÷49
Bauli portautensili	208
Beta Collection	390÷399
Bordatubi	26-27
Borse portautensili	204÷207
Brucciatori per saldatori gas	23-24
Bulini	9
Cacciaspina	9, 183
Calibri a corsoio	147
Calzature di sicurezza	332÷353
Carrelli porta cassettiere	211
Carrelli portautensili	220÷222, 236-237
Cassettiere mobili	210÷220, 223÷232
Cassettiere portatili	209-210, 225, 230
Cesoie a cricchetto per tubi PVC	25-26
Cesoie	98-99
Cestelli portautensili	207-208, 235
Chiavi per ponteggi	15, 184
Chiavi a bussola con impugnatura	84-85, 177-178
Chiavi a bussola Macchina, accessori e assortimenti	50÷56, 186-187
Chiavi a bussola snodate doppie	13-14
Chiavi a bussola, accessori e assortimenti 1/4"	62÷66
Chiavi a bussola, accessori e assortimenti 3/8"	66÷71
Chiavi a bussola, accessori e assortimenti 1/2"	71÷79, 177, 185
Chiavi a bussola, accessori e assortimenti 3/4"	79-80, 185-186
Chiavi a bussola, accessori e assortimenti 1"	81
Chiavi a cricchetto	21÷23, 128
Chiavi a forchetta	11÷13, 177, 183
Chiavi a percussione	13, 183-184
Chiavi a pipa	82-83, 186
Chiavi a settore	20, 185
Chiavi a T con bussola esagonale e Torx®	84÷87
Chiavi a T maschio esagonale e Torx®	85-86, 176
Chiavi a tubo	82-83, 86
Chiavi a zampa di gallo	68
Chiavi combinate	10-11, 21-22, 181, 183
Chiavi di manovra antiscintilla per valvole	186
Chiavi e barre dinamometriche	45÷50, 177
Chiavi maschio esagonale e Torx®, piegate	16÷20, 181, 184-185
Chiavi maschio esagonale e Torx® con impugnatura	18÷20, 105-106, 108÷114, 181

Indice alfabetico



Chiavi maschio piegate a profilo XZN®	20
Chiavi per raccordi	15, 21
Chiavi poligonali	13÷15, 22-23, 128,177, 184
Chiavi regolabili a rullino	20-21, 177, 185
Coltelli	167, 179, 188
Comparatori	148
Compassi	149-150
Compressori a leva per grasso	161
Contafiletti	153
Contaltri per olio	173
Cuffie antirumore	368
Curvatubi	29
Cuscino sollevatore	167
Cutter	166-167
Estrattori per viti e prigionieri danneggiati	120-121
Estrattori a due griffe	135÷137, 141
Estrattori a tre griffe	136-137, 141
Estrattori coni Morse	34
Estrattori idraulici	141
Estrattori per mozzi e tamburi ruote	137
Estrattori vari	135÷139, 141
Fascette	160
Filiere e assortimenti	37÷41
Flessibili magnetici	153
Flessometri e metri	151
Forbici	99-100,167,178,188
Forbici per elettricisti	99-100
Frese coniche	33-34
Fustelle	98
Gamma blister	309÷317
Giramaschi e girafiliera	36-37, 39
Giratubi	28-29, 185
Giravite a battere	106-107
Giravite a percussione	114
Giravite a squadra	106
Giravite BetaEasy	104÷106
Giravite BetaGrip	109÷112, 179
Giravite BetamaX	112÷114, 181, 187
Giravite bivalenti	111-112
Giravite cercafase	107
Giravite dinamometrici	44-45
Giravite prensili	107
Goniometri per serraggi angolari	46
Goniometri semplici	149
Guanti isolanti	179
Idraulica, vari	23÷30
Inseriti per avvitatori e portainseriti	21-22, 56÷62, 107-108, 111, 177
Lampade	169÷171, 243
Leve	89-90, 152-153, 186
Lime	34, 116, 154÷157, 188
Livelle e stadie	151-152
Magnetizzatore-smagnetizzatore	104
Martelli	116÷120, 187-188
Martinetto idraulico	141, 174

Indice alfabetico



Mascherina antipolvere	368
Maschi e assortimenti	34÷37, 39÷41
Matita per falegnami	151
Mazze	119, 187
Mazzette	119, 187
Mazzuole	119-120, 188
Microgiravite	107-108
Micrometri	147-148
Misuratori di coppia elettronici Dynatester	45, 50
Moltiplicatori di coppia	43÷45
Morse parallele da banco	142-143
Morse ribaltabili da banco, per idraulica	30
Morsetti	142
Multimetri	163-164
Nastro isolante	146
Occhiali di protezione	368
Oliatori	161-162
Pala antiscintilla	188
Pareti portautensili	240÷244
Pennello	158
Piccone antiscintilla	188
Pinza foralamiera	96
Pinza fustellatrice	165
Pinza per fascette e fascette	160
Pinza piegalamiera	96
Pinze a becchi lunghi e lunghissimi	92-93, 101-102, 178-179, 187
Pinze allargatubi	26-27
Pinze amperometriche	163-164
Pinze autobloccanti	94÷96, 125, 128
Pinze per anelli elastici di sicurezza	93
Pinze per capicorda e capicorda	143÷146
Pinze per elettronica	102÷104
Pinze regolabili	94, 101, 178, 186
Pinze torcifilo	164
Pinze universali	101, 178, 187
Pinzette a molla	91-92, 178
Pistole per colla	172
Pistola per olio	172
Pistole per sigillanti	160
Pistole termiche	171-172
Polifusori e matrici	23
Pompe per barili	172
Pompette per dissaldare	168
Porta attrezzi con cintura	204
Portacarta	218-219
Portaflaconi	218-219
Portaminuterie magnetici	165
Postazione di lavoro mobile	223
Provatensione	133, 171
Punte elicoidali cilindriche per forare	30÷33
Punte per forare, filettare e svasare	37
Punte per tracciare	150
Punte speciali per saldature	33
Punteruoli	154

Indice alfabetico



Punzonatrice oleodinamica	146-147
Punzoni	9, 183
Raggimetri	153
Rapportatore d' angoli	149
Raschietti	128-129, 154, 166, 188
Righe graduate	150
Rivettatrici e rivetti	158÷160
Saldatori	167-168
Saldatrici	172
Sbavatori per tubi	26
Scalpelli	9-10, 183
Scalpelli per carrozzieri	98-116
Scalpelli per edilizia	152, 188
Segaccio per legno	158
Seghe e frese a tazza e accessori	41÷43
Seghetti e lame	157-158, 188
Segoncino ad arco	157
Serragiunti e strettoi	142
Siringa per olio	162
Sonda tirafili	146
Soluzioni per il punto vendita	318÷329
Spaccadadi	153
Spazzole	158, 188
Specchietti	154
Spellacavi e spellafilii	100-101
Spessimetri	153
Squadre	148-149
Supporto per avvitatore pneumatico	219
Tachimetro digitale	164
Tagliacavi	100
Tagliacavi per cavi in acciaio	100
Tagliafuni di acciaio	98
Tagliatubi	24-25, 185
Tappeto isolante	179
Tenaglie	97
Tenditore per molle	157
Termoformati portautensili	291÷306
Termometri	164-165
Termopiastre per tubi plastici	23
Torçe	169
Traccialinea e polvere	153
Trolley portautensili	205-206, 233-234
Troncabulloni	97
Tronchesi a taglienti diagonali e frontali	96-97, 103-104, 178, 187
Tronchesi per elettronica	103-104
Ugnetti	10
Utensili antiscintilla	182÷188
Utensili in acciaio inossidabile	180÷181
Utensili isolati 1000V	176÷179
Utensili pneumatici ed accessori	189÷202
Valigie portautensili	204÷207
Ventose	165
Zaino portautensili	206

Indice alfabetico utensili per autoriparazione



Alesatori per sedi iniettori	88
Aspiratore di vapori iniettori Diesel	88
Attrezzi per estrazione autoradio	165
Attrezzi per pistoni	122
Attrezzi per pulegge distribuzione	125, 130, 137
Attrezzi per rimozione cristalli	165
Attrezzi per sostituzione piattelli valvole	125
Attrezzi per tubi scarico	128
Attrezzo per pistoncini freni a disco	126
Attrezzo per smagliatura catene	141
Attrezzo universale per centraggio frizioni	121
Avviatori	133
Barre di torsione per dadi ruote	55
Calibri a corsoio per dischi e tamburi freni	147
Calibro per battistrada pneumatici	153
Caricabatteria	134
Carrello per movimentazione veicoli	173
Cavalletti	173
Cavalletti per moto	175
Chiave per braccetti sterzo	141
Chiavi a bussola Macchina per dadi ruote	51-52
Chiavi a bussola Macchina quadre per dadi ruote Isuzu	54
Chiavi a bussola Macchina per dadi assale	90
Chiavi a bussola per dadi mozzi ruote	90
Chiavi a bussola per dadi mozzi ruote veicoli pesanti	90
Chiavi a bussola per iniettori Diesel	87
Chiavi a bussola per perni balestre	140
Chiavi a bussola per sonda Lambda	87
Chiavi a croce per dadi ruote	91
Chiavi e bussole per candele d' accensione	87
Chiavi per filtri gasolio	132
Chiavi per filtri olio motore	130-131
Chiavi per ghiera galleggiante serbatoio	129
Chiavi per tappi scarico olio motore	132
Chiave per turbine	128
Densimetro per liquido anticongelante	162
Densimetro per liquido batteria	162
Estrattori per giunti omocineticici	141
Estrattori per pioli	128
Estrattori per snodi sferici	140
Gru idraulica pieghevole	174
Imbuto	162
Lettini sottomacchina	173
Levagomme	89
Leve per carrozzieri	115-116
Lime per carrozzieri	116
Martelli per carrozzieri	116-117
Messa in fase	122÷125

Automotive

Indice alfabetico utensili per autoriparazione

Morsetti alzavalvola	122
Pinza per anelli di tenuta valvole	122
Pinza per anelli elastici di sicurezza SP	122
Pinza per equilibratura ruote	91
Pinza per tubi impianto frenante	125
Pinze per anelli stringitubo	127
Pinze per cappucci candele	128
Pinze per freni	126
Pinze per occlusione tubi e manicotti	129
Pinze per raccordi rapidi tubi carburante	129
Pistola per gonfiaggio pneumatici	200
Pompa per taratura e controllo iniettori Diesel	88
Pressa idraulica	174
Pressori per molle ammortizzatori	139-140
Provatensione	133, 171
Rabboccatore per batterie	162
Seggiolino con rotelle	173
Smerigliavalvole pneumatico	122
Sollevatore idraulico a 6 ruote	175
Sollevatori idraulici a bottiglia	174
Sollevatore idraulico da fossa	174
Sostegni motore	174
Spatoline in acciaio Inox	116
Spazzola per morsetti batteria	158
Stetoscopio	134
Strumenti estrazione liquido freni	125
Strumenti per controllo impianto raffreddamento	162
Strumento per controllo compressione motori a benzina e Diesel	88-89
Tassi per carrozzieri	114-115
Tenditori per molle	120, 157
Tester digitale alta pressione common rail	89
Tester liquido freni	125
Tester per batteria e impianti di ricarica	134
Utensili per airbag	121
Utensili per bobine candele	127
Utensili per connessioni elettriche	133
Utensili per impianti di condizionamento	129
Utensili per iniettori Diesel Common Rail	88
Utensili per rimozione candele preriscaldamento	89
Utensile per rimozione guarnizioni	137
Utensili per silent block e paraoli	141
Utensili per veicoli pesanti	90, 140

Indice Alfanumerico

30	9
30BA	183
31	9
31BA	183
31BM	9
31L	9
31SE	9
32	9
32AU	9
32AUR	9
34	9
34BA	183
35	9
35PM	9
35PMR	9
36	9
37	10
37PM	10
37PMR	10
38/DS1	319
38/DS2	319
39BA	183
42	10
42AS	11
42BA	183
42BA/AS	183
42K	310
42MP	11
42LMP	11
42/SC9I-E	10
45	11
52	11
52MQ	177
53	12
55	12
55AS	12
55BA	183
55BA/AS	183
55K	310
55MP	12
58	13
58BA	183
73	13
78	13
78AS	13
78BA	184
78BA/AS	184
80	13
83	14
83AS	14
89BA	184
89MQ	177
90	14
90AS	14
90BA	184
90K	310
91	15
91BA	184
92	15
92BA	184
93	15
93BA	184
93C	15
93K	310
94	15
94K	310
95	15
95BA	185
95FTX	15
96	16
96BA/BP	185
96/SC9	16, 310

96AS	17
96AS/BG7	17
96BA	184
96/BG7	16, 311
96/BGS7	16, 311
96BP	18
96BP/AS	18
96BPA	18
96BPA/SC9	18, 310
96BPC	17
96BPC/SC9	17, 310
96L	17
96LBP	18
96LBP/SC	18, 310
96LC	17
96N	16
96N/ST6K	310
96T	18
96T/AS	18
96T/SPV	308
96TBP	19
96TK	311
97TX	19
97BTX	19
97BTX/SC	19, 311
97RTX	19
97TTX	20
98XZN	20
97TX/ST	19
99	20
99BA	185
99SQ	20
99ST	20
99 VN/...	20
100	20
100/KIT	20
110BA	185
110MQ	177
111	20
111G	21
111K	311
111N	21
120	21
123E1/4	21
123Q1/4	21
123Q3/8	21
123Q1/2	21
123/K4	21, 311
142	21
142/SC9I-E	21
142AS	22
142C	22
142K	311
142SN	22
188	22
192	22
192/S2	22, 311
194	22
195	22
195FTX	23
195K	311
195P	22
310	23
310B	23
310/C4	23
310/C8	23
311	23
312A	23
312B	23
312BR	24
312BR/A	24
312F	23

312G	23
312G/RC	24
312G/RM	23
312PC	24
330	24
330BA	185
330R/A	24
330R/I	24
331L	24
332	24
334	24
334R	24
334R/I	24
336	24
338	25
338R	25
338R/I	25
338RP	25
339A	25
339A/R	25
341	25
341B/RL	25
341B/RM	25
341RL	25
342	25
342A	25
342A/MOL	25
342A/RL	25
342MOL	25
342P	26
342P/RL	26
342RL	25
344	26
345	26
345SB	26
345SB/R	26
345U	26
349	26
349/SMAS	26
349/SMM	26
350	26
351C	26
351P	26
352	26
352C	27
352C/U	27
352P	27
352PR	27
352U	27
353N	27
353N/C6	27
353NM	27
355	27
357 F3	27
358	27
358RL	27
359	28
359CH	28
360	28
360R/...	28
362	28
362R/...	28
363	28
363BA	185
363R/...	28
365	28
365R/...	28
366	28
374	28
374R/...	29
375	28
376	28

378	28
378BA	185
383	29
383R	29
384	29
384RC	29
386A	29
386A/RC	29
386BA	185
388	29
388A	29
388C/C8	29
392C	29
392RG/C	29
393	29
395	29
395T	30
399	30
410	30
410A	30
410AS	30
410MIX/SEL19	30
412	31
412A	31
412/C150	31
412L	31
414	32
414/C116	32
415	32
415/C116	32
416	33
417	33
419	33
423	33
423A	33
424	33
425	33
426	34
426MD	34
426SB	34
427	34
428/C14	35
428FC	35
428FP	34
429/C14	35
429FC	35
429FP	35
430	35
430ASC	35
430ASW	35
431	36
433	36
433ASF	36
433ASG	36
434	36
435	36
435G	36
436	37
436L	37
436R	37
437C	37
437C/...	37
437C/RM14	37
437U/09	37
437U/E-M...	37
437U/PM	37
438A	37
438...	37
440	37
440A	38
440ASC	38
440ASF	38

Indice Alfanumerico

440ASG	38
440ASW	38
440B	38
441	38
441A	38
441B	39
442	39
443	39
444	39
444G	39
446/C30	39
446/C48	39
446/C110	40
446ASC/C37	40
446ASF/C29	40
446ASG/C23	40
446ASW/C36	40
447/C37	41
447/C53	41
447/C70	41
450	41
450/C9	42
450/C13	42
450/C21	42
450AD	41
450AL	41
450PA/1	42
450PA/2	42
450PR	42
451	42
451GA	42
451PA	42
451PR	43
452	43
452GA	43
560/C2	43
560/C4+	43
560/C6	43
560/C12	43
561	43
562/1 - 562/2	44
564/3R - 564/4R	44
565/1R - 565/2R - 565/3R	44
565/4R	44
565/5R	44
567/4R	44
567/5R	44
581	44
583	45
583/C31	45
588	45
590 - 592/4	45
594/8 - 594/21	45
596/80SL - 598/200SL	45
599DGT	46
599DGT-A	46
600/1 - 600/2	46
603	46
604B	46
606/2 - 606/2X	47
606/6 - 606/30	47
606MQ/50	177
608/2	47
611	47
612 - 614	47
614/50	47
616 - 617 - 619	47
641	47
642	47
652	48
666	48
667	48

668	48
668RG	48
669	48
669RG	49
671B/C5	49
671B/C10	49
671/C10	49
671/C20	49
671/C30	49
677	49
678	50
678/C...	50
678/CV...	50
680/40	50
682	50
710	50
710/16	50
710/20	50
710/21	50
710/25	50
710/C10	51
710/OR... - 710/SP...	51
720	51
720/15	52
720/16	52
720/20	52
720/21	52
720/25	52
720/C6	53
720/C12	53
720/OR... - 720/SP...	53
720AS	51
720FTX	52
720IP	52
720L	51
720L/S3	51
720LPL	51
720LPL/C3	52
720LS	51
720ME	52
720ME/C8	52
720PL	51
720PL/C5	51
720T	53
720TX	52
720TX/C6	52
727/C16	53
727/ES16	53
727/ES16TX	53
727/ES22	53
727/ES22TX	53
727/ES32	54
727PI/16	53
727PI/22	53
727PI/32	54
728	54
728/15	54
728/16	54
728/21	54
728/22	54
728/25	54
728/22L	54
728/C10	55
728FTX	54
728L	54
728LS	54
728LS/S3	54
728LQ	54
728/OR - 728/SP	55
729	55
729/15	55
729/16	55

729/21	55
729/22	55
729/25	55
729L	55
729LS	55
729/OR... - 729/SP...	55
729T	55
730	56
730/15	56
733/15	56
850MQ	177, 311
851	56
851SR	56
855P	56, 311
855T	56
860/55	57
860/C27	57, 311
860LP	56
860PE	56
860PH	56
860PZ	56
860RTX	57
860TX	56
860MIX/A10	58, 311
860MIX/A31	58, 311
860PE/A10	57
860PHT/A31	58
860PHZ/A10	57
860PHZ/A31	57
860RTX/A10	58
860TX/A10	57, 311
860TX/A31	57
860/C38P	58
861/C61P	59
861LP	58
861PE	59
861PH	58
861PH/C	58
861PZ	58
861PZ/C	59
861RTX	59
861SP	59
861TQS	59
861TRW	59
861TX	59
861TX/C	59
862F	60
862F/A7	60, 312
862LP	59
862PE	60
862PH	59
862PH/L	60
862PZ	60
862TX	60
862TX/L	60
866LP	60
866PH	60
866PZ	60
866PE	60
866TX	60
867/...	61
867/C52	61
867PE	61
867PE/L	61
867RTX	61
867RTX/L	61
867TX	61
867TX/L	61
867XZN	61
867XZN/L	61
882	61
882M	62

882M1	61
882 MSR	62
882P	62
892	62
895	62
897	62
897L	62
900	62
900/...	64
900/16	64
900/20LK	312
900/25	64
900/25K	312
900/32	64
900/35A	64
900/40	64
900/42	64
900/55	65
900/55K	312
900/C11	65
900/C13-5	65
900/C13-8	65
900/C24	65
900AN	64
900AS	63
900AS/C10	66
900AS/MB-C17	66
900AS/C17-MBM	66
900AS/L	63
900AS/MB	63
900AS/MBL	63
900BG/30	64
900BG/30C	64
900BG/30K	312
900K	312
900FL	64
900FTX	63
900L	62
900LP	63
900LPH/SB7	63
900M/35	64
900M/55	65
900M/R55	81
900MB	62
900MB/C19	65
900MB/C28	66
900MB/L	63
900ME	63
900PH	63
900PT	64
900TX	64
900/R55	81
902R/C6	66
910/15	69
910/16	69
910/21 - 910/22	69
910/25	69
910/36A	69
910/40	69
910/42	69
910/46	69
910/55	69
910/55Q	69
910/R55	81
910/R55Q	81
910A	66
910A/AS	67
910A/C16	70
910A/C17	70
910AL	67
910AN	69
910AS	67

Indice Alfanumerico

910.../C10	70
910.../C29	71
910AS/C13	71
910AS/L	67
910AS/MBM-C18	71
910AS/SN	67
910A/C10	70
910A/C29	70
910B	66
910B/C16	70
910B/SN	67
910BL	67
910CF	68
910FTX	68
910FTX/L	68
910LH/SB7	68
910LP	68
910M/35	69
910M/55	69
910M/56	70
910M/R55	81
910ME	68
910PE	68
910PH	68
910PT	68
910TX	68
920/15	75
920/16	75
920/20 - 920/21 - 920/22	75
920/21K	312
920/25	75
920/25K	312
920/35A	75
920/36A	75
920/40	75
920/42	75
920/44	75
920/46	76
920/50	76
920/50F	76
920/55	76
920/55K	312
920/55LC	76
920/55Q	76
920/55X	76
920/56A	76
920.../C11	76
920.../C12...	77
920.../C20...	77-78
920.../C21...	78
920.../C33	78
920/C37	78
920/R50	81
920/R55	81
920/R55LC	82
920/R55Q	81
920/R55X	82
920A	71
920A/AS	72
920AK	312
920AL	71
920AN	75
920AS	72
920AS/C10	78
920AS/C15	79
920AS/C17X	79
920AS/L	72
920AS/MBM-C21	79
920B	71
920B/C30Q	78
920BL	72
920BP	73

920ES	74
920FTX	72
920FTX/L	72
920LH/SB7	73
920LP	73
920M/35	75
920M/35L	75
920M/55	76
920M/56	76
920M/R55	81
920ME	74
920MQ/21	177
920MQ/22	177
920MQ/55A	177
920MQ/A	177
920MQ/C16	177
920MQ/PE	177
920MQ/T	177
920PE	73
920PE/AS	73
920PE/LS4	73
920PH	73
920RTX	74
920TX	74
920TX/C17	79
920TX/LSB	74
920XZN	74
921BA	185
921BA/21 - 921BA/22	185
921BA/25	185
921BA/42	185
921BA/50	185
926BA	185
926BA/22	186
926BA/42	186
926BA/50	186
928/15	80
928/16	80
928/21 - 928/22	80
928/25	80
928/36A	80
928/42	80
928/55	80
928A	79
928A/C12	80
928AS	80
928AS/C12	80
928B	79
928ME	80
928/R55	82
928/R55X	82
929	81
929/15	81
929/21 - 929/22	81
929/42	81
929/55	81
929/C8	81
929/R55	82
930	82
932	82
933	83
935	83
935K	312
937	83
937BA	186
937K	312
940	83
941	83
942BX	83
942BX/DG	319
943BX	84
943BX/DG	319

943FL	84
943MQ	177
943MQ/BG	319
944BX	84
950	84
951	85
951AS	85
951K	312
951MQ	178
951TX	85
952	85
952AS	86
952FTX	86
952L	86
953	86
953TX	86
955	86
956C	86
956E	86
956L	86
957	87
959	87
959R	87
960	87
960A	87
960AD/TP2	89
960AVE	88
960AVL	88
960BT	87
960BT/B	87
960CMB	88
960CMD	88
960F	87
960G	87
960H/C4	88
960KI	88
960K/AVE	88
960KIT/1	88
960KPC	89
960KC-M8	89
960L	87
960M	87
960P	89
960PMC	88
960S	87
960SL	87
960SN	87
960PI	88
960TAP	89
960TP	89
960W	89
961BA	186
962	89
963	89
963BA	186
964	90
964BA	186
964BA/L	186
965	90
965BA	186
966BA	186
966/C3	90
966BA/V	186
969A	90
969B	90
969/C5	90
970B	90
970C	90
970EA	90
970EB	90
970OT	90
970Q	90

978 - 979	91
982	91
983	91
985	91
988/K4	91
989	91
990	91
991	91
992	91
993	91
993G	91
993MQ	178
993PL	91
994	91
994MQ	178
994PL	92
994TF	92
996	92
998	92
999	92
999/B6	92
999A	92
999B	92
999C	92
999D	92
999E	92
999G	92
1008	92
1008BM	92
1009	92
1009L/A	92
1009L/B	93
1009L/C	93
1010	93
1010BM	93
1010MQ	178
1032	93
1032K	312
1033	93
1034	93
1034K	313
1034L	93
1036	93
1036K	313
1037	93
1038	93
1038K	313
1039	93
1044	94
1044K	313
1044F	94
1044FK	313
1046	94
1046BA	186
1046K	313
1047	94
1047BM	94
1048	94
1048BM	94
1048MQ	178
1048K	313
1048V	94
1048VK	313
1050	94
1051	94
1051GM	94
1051L	95
1051XL	95
1052	95
1052K	313
1053	95
1054	95

Indice Alfanumerico

1055	95
1056	95
1057A	95
1058	95
1060	95
1061	95
1062	96
1062AL	96
1062GM	96
1063	96
1064	96
1065F	96
1065P	96
1077	96
1078	96
1080D	96
1082	96
1082BA	187
1082BM	96
1082BMK	313
1082MQ	178
1084	97
1084BM	97
1084BMK	313
1084MQ	178
1088	97
1088BM	97
1088MQ	178
1092V	97
1094V	97
1095N	97
1096	97
1096K	313
1098	97
1098K	313
1098PL	97
1098PLK	313
1101	97
1101R	98
1102	98
1104	98
1104R	98
1105	98
1105AD-50	98
1105/C15T	98
1105/C29T	98
1105T30	98
1105T50	98
1112	98
1112K	313
1114	99
1118	99
1120A	99
1120ARL - ARG	99
1122	99
1122K	313
1123	99
1123K	313
1124	99
1124K	313
1125	99
1126	99
1127	99
1127MQ	178
1128BCX	99, 314
1128BMX	99, 314
1128BSX	99, 314
1128BTX	99, 314
1128BM	100
1129BM	100
1130BMX	100, 314
1131CK	100

1132	100
1132BM	100
1132MQ	178
1133	100
1133RL	100
1134	100
1134A	100
1134A/RL	100
1134RL	100
1136	100
1137BA	187
1137BA/RC	187
1142BM	100
1142BMK	314
1142MQ	178
1143	100
1143R	101
1144	101
1144RC	101
1144D	101
1144D/RG	101
1144D/RL	101
1145	101
1145RG	101
1148A	101
1148A/R	101
1148B	101
1148B/R	101
1149F	101, 314
1150	101
1150BA	187
1150BM	101
1150BMK	314
1150MQ	178
1153	101
1162	101
1162BA	187
1162BM	102
1162BMK	314
1162MQ	178
1164	102
1164BM	102
1164BMK	314
1164MQ	179
1166	102
1166BA	187
1166BM	102
1166BMK	314
1166MQ	179
1168	102
1168BM	102
1168BMK	314
1168MQ	179
1171BM	102
1172BM	102
1172BM/P	102
1173BM	103
1175BM	103
1177BM	103
1177BM/Z	103
1178BM	103
1178BM/P	103
1182BM	103
1183BM	103
1184BM	103
1185BM	104
1186BM	104
1188BM	104
1190BM	104
1191BM	104
1191BM/L	104
1200MS	104

1201	104
1201DZ	105
1201K	314
1201N	104
1201NK	314
1202	105
1202K	314
1202N	105
1202NK	314
1203/D	105
1203/S10	105
1203/E1P	319
1203/E4P	320
1203/E5P	320
1203/E10P	320
1204	105
1204K	314
1207TX	105
1207TXK	315
1208RTX	106
1208RTXK	315
1209PZ	106
1209PZK	315
1229LP	106
1229LPH/A6	106
1229PH	106
1236B	106
1238B	106
1241	106
1242	106
1243/D7	107
1250	107
1251	107
1252/S5	107
1253	107, 315
1253A	107
1254	107, 315
1256LP	107
1256PE	107
1256PH	107
1256PZ	107
1256RTX	108
1256TX	108
1256/C36-2	107
1256/20	108
1256/30	108
1257BE	108
1257ES	108
1257ESB/S8	108
1257LP	108
1257LPH/S8	108
1257PH	108
1257TX	108
1260	109
1260K	315
1260E	109
1260EK	315
1260N	109
1260NK	315
1262	109
1262K	315
1262N	109
1262NK	315
1262E	109
1262EK	315
1262L	109
1263/D...	109
1263/E80	320
1263/E85	320
1263/E70	320
1263/E50	321
1263/E62	321

1263/E39	321
1263/E40	321
1264	110
1264K	315
1264L	110
1265ES	110
1266BP	110
1267TX	110
1267TXK	315
1268RTX	111
1268RTXK	316
1269N/PZ	111
1269N/PZK	316
1269PZ	111
1269PZK	316
1270BA	187
1272BA	187
1272MQ	179
1273MQ/D6	179
1273MQ/E1	321
1274MQ	179
1279MQ	179
1281BG	111
1281BG/A9	112
1281BG/B28A	112
1281BG-TX/A8	112
1281LP	111
1281LPH	111
1281PB	111
1281PE	111
1281PH	111
1281PM	111
1281PZ	111
1281RTX	112
1281TX	111
1290	112
1290K	316
1290/S...	112
1290N	112
1290NK	316
1292	112
1292K	316
1292L	113
1292N	113
1292NK	316
1293/D...	113
1293/S...	113
1293BP	113
1293BX/DA	321
1293BX/DD	322
1293BX/DE	322
1293BX/DE	322
1293BX/DF	322
1293ES	113
1294	113
1294K	316
1294L	114
1295	114
1295/C14	114
1297TX	114
1298RTX	114
1298RTXK	316
1299N/PZ	114
1299N/PZK	316
1299PZ	114
1299PZK	316
1302	114
1303	114
1304	115
1305	115
1305Z	115
1306	115

Indice Alfanumerico

1307	115
1308	115
1309	115
1310	115
1312	115
1313	115
1314	115
1326	115
1327	115
1328	115
1329	115
1330	115
1331	116
1335BM	116
1337/S5	116
1338	116
1338A - 1338B	116
1338R9 - 1338R12	116
1342	116
1342PM	116
1342PMR	116
1343	116
1345	116
1345P	116
1351	116
1353	116
1357/32 - 1357/40	116
1357Z/32 - 1357Z/40	116
1359T	117
1369/C11X	117
1370	117
1370/MR...	117
1370BA	187
1370BA/MR	187
1370F	117
1370F/MR...	117
1370FT	117
1370T	117
1374F	117
1374F/MR...	117
1375	118
1375/MR	118
1375A	118
1375B	118
1376X	118
1376X/MR	118
1376XT	118
1376XT/MR	118
1377	118
1377/MR...	118
1377BA	187
1378	118
1378/MR...	118
1379BA	187
1379F	118
1379F/MR...	118
1380	119
1380/MR...	119
1380BA	187
1380BA/MR	187
1380S	119
1380S/MR...	119
1380T	119
1381	119
1381/MR...	119
1381BA	187
1381BA/MR	188
1381T	119
1385	119
1385/MR	119
1390	119
1390BA	188

1390/MR...	119
1390R	120
1390N	120
1390NR	120
1391	120
1391A	120
1392	120
1392R	120
1393	120
1410/M	120
1428	120
1428/SB11	120
1428L	120
1428L/B3	120
1429	120
1429/SB7	121
1430/...	121
1433	121
1433/C11	121
1435	121
1435/1	121
1435/1R	121
1435R	121
1437/C12	121
1438	121
1438R	121
1439/K7	121
1440/...	122
1445/1 - 1445/2	122
1450GC	122
1452K	122
1452PN/K	122
1455SVP	122
1455SVP/R...	122
1458	122
1460F	122
1461BF	122
1461PMS	122
1461/C3B	122
1461/C5G	122
1461/C6B	123
1461/C6G	123
1461/C7B	123
1461/C8B	123
1461/C8G	123
1461/C9B	123
1461/C10A	123
1461/C10G	123
1461/C11A	123
1461/C11G	123
1461/C12A	123
1461/C12G	124
1461/C13A	124
1461/C13B	124
1461/C14	124
1461/C15	124
1461/C16	124
1461/C17	124
1461/C17B	124
1461/C18	124
1461/C18B	124
1461/C19	124
1461/C20G	125
1463/KIT	125
1467	125
1467LF	125
1468N	125
1469	125
1469C	125
1469C-R	125
1469D	125
1470	126

1470FT	126
1471	126
1471/S4	127
1471A	126
1471CF	126
1471CM	127
1471CM/E11	127
1471D	127
1471M/50	126
1471M/C22	126
1471M/P	126
1471M/W50	126
1471PN/B1	126
1471PN/B2	126
1471PN/B3	126
1471PN/B4	126
1471PN/B5	126
1471U	126
1472	127
1472AU	127
1472AU/P	127
1472FC	127
1472FC/L	127
1472TM	127
1473	127
1473A	127
1473Q	127
1474/C4	127
1474DL	128
1474L	128
1475U	128
1476	128
1476/RC	128
1476A	128
1476A/RC	128
1476C/1 - 1476C/2	128
1476T	128
1477D	128
1477D/S5	128
1477K/7	128
1478	128
1479	128
1479RB/1	128
1479RB/2	129
1479RB/3	129
1479U/13	129
1479U/32	129
1479N/S5	129
1481PL/A	129
1481PL/B	129
1481PL/C	129
1481PL/S3	129
1482/8 - 1482/10	129
1482A	129
1482G/...	129
1483K/22	129
1484	129
1485/KIT	130
1485R	130
1485R/P10	130
1485R/P17	130
1486M	130
1486T	130
1488 - 1488L	130
1488/1	130
1489/31T	130
1489/33	130
1489/33P	130
1489/E	130
1489/Y	130
1489R	130
1489/C14	130

1490/1 - 1490/2	131
1491	131
1491C	131
1491R	131
1492/1 - 1492/2	131
1492T	131
1493	131
1493/PF	131
1493/C30	131
1493/S-U	131
1493T	131
1493J	132
1493Z/1 - 2 - 3	132
1494	132
1494E	132
1494Q	132
1494T	132
1494XZN	132
1494/C14A	132
1495/C6	132
1495M	132
1495T	132
1496/A	132
1496/B	133
1496/C	133
1496/D	133
1497D	133
1497P	133
1497/C23	133
1498	133
1498B/12	133
1498B/24	133
1498C/24	133
1498CB/40	134
1498CB/M-40	134
1498CB/80	134
1498CB/120	134
1498CB/300	134
1498TB/ST	134
1499	134
1500/...	135
1500G/...	135
1500N/...	135
1500N/G...	135
1501/1 - 2 - 3	135
1501G/1 - 2 - 3	135
1501Z/S - P - R	135
1505	136
1506	136
1508/1 - 1508/2	136
1511/1 - 2 - 3	136
1515/1 - 2 - 3	136
1516/1 - 2 - 3	136
1517	136
1517G	136
1517GS	137
1517T	137
1517V	137
1518/...	137
1520/1 - 1520/2	137
1521/1 - 1521/2	137
1529	137
1530/C5	137
1532	137
1533/...	137
1533PR/1 - 2 - 3	137
1534/...	138
1535/C...	138
1539	138
1540	138
1542/1 - 1542/2	138
1544/...	138

Indice Alfanumerico



1545/C5	138
1547/C6	139
1547KP	139
1547P	139
1547PC/2	139
1547PL/2	139
1550/1	139
1550/MRC	139
1550/PS	139
1550/SR...	139
1555/QS	140
1555C	140
1555DS	139
1555S/MRC-C	139
1555S/BMW-RNT	140
1556/1A	140
1556/2A	140
1556/3A	140
1557	140
1557/S3	140
1557V	140
1559	140
1559V/8T	140
1560/1 - 1560/2	140
1560A	140
1561/...	141
1562D	141
1565/1 - 2 - 3	141
1566N	141
1566G0	141
1568/C15	141
1568R/CS3	141
1569	141
1570/3	141
1580/8I	141
1580GL	141
1585/5I - 6I - 7I	141
1585GI/5 - 6 - 7	142
1589PI/50 - 100 - 150	142
1589VI	142
1590	142
1591	142
1593	142
1594	142
1594A	142
1594A/RG	142
1595	142
1596	142
1596/RG	142
1599B	143
1599F	142
1599G	143
1599P	143
1599T	143
1601/PC	143
1602	143
1602/C9T	143
1602A	143
1603	143
1603A	143
1603B	143
1603BK	316
1604	144
1604/C9T	144
1605	144
1606	144
1606A	144
1606A/C9	144
1607	144
1608	144
1608/C9T	144
1608A	145



1609	145
1609A	145
1609B	145
1609C/C5	145
1609M	145
1610	145
1614	145
1616	145
1618	145
1620	145
1622	146
1624	146
1628	146
1630	146
1632	146
1634	146
1639NS-N	146
1639S	146
1640	146
1640A	146
1640K	146
1640P	146
1640Q	146
1640T	147
1650	147
1650FD	147
1650FT	147
1651DGT	147
1652	147
1654	147
1654DGT	147
1656	147
1657DGT/2	147
1658/...	147
1658/C4	147
1658DGT	148
1658SP/1	148
1659	148
1662/1 - 1662/2	148
1662AN	148
1662DGT	148
1662SP0	148
1662SP2	148
1666A	148
1668A	148
1670	149
1670A	149
1672	149
1672A	149
1674A	149
1676	149
1678/C3	149
1679	149
1680	149
1680A	149
1680B	149
1680C	150
1682	150
1683	150
1685/C7	150
1687/S4	150
1687A	150
1687AC	150
1687D	150
1687U	150
1688	150
1688A	150
1688BC	150
1688BC/R	150
1688M	151
1690F	151
1690L	151



1691BG	151, 316
1692	151, 316
1694/L	151
1694A/L	151
1694B/L	151
1696	151
1696A	151
1696B	151
1696D	151
1696S	152
1699L	152
1699L/1	152
1699Q	152
1700N	152
1700N/PM	152
1701BA	188
1701N	152
1701N/PM	152
1701NE/...	152
1701PMR	152
1702N	152
1702N/PM	152
1702PMR	152
1703BA/P	188
1703BA/PL	188
1704	152
1704A	153
1704C	153
1705	153
1705PT	153
1706DGT	153
1707	153
1707A/1 - 2 - 3	153
1708/8 - 13 - 20	153
1709/10 - 1709/18	153
1710	153
1712E/1 - 2 - 3	153
1712E/L1	153
1712TF	153
1713M	153
1714	154
1715	154
1715FL/A	154
1715FL/B	154
1716A	154
1716P	154
1716Q	154
1716R	154
1716U	154
1717A	154
1717B	154
1717BA	188
1717BA/1	188
1717C	154
1717D	154
1718A6/...	154
1718A8/...	154
1718A10/...	155
1718D6/...	155
1718D8/...	155
1718D10/...	155
1719BA	188
1719BMA	155
1719BMA6/S5	155
1719BMA8	155
1719BMA8/S	155
1719BMA10	156
1719BMA10/S5	156
1719BMB/P	156
1719BMC	156
1719BMD6	156
1719BMD8	156



1719BMD10	156
1719BM/RR	156
1719BM/RL	156
1719BMR	156
1719R/...	156
1720/...	157
1720/B	157
1720D/...	157
1720D/B	157
1721/B6	157
1723	157
1725	157
1725CR	157
1725MQ	179
1726	157
1726BM	157
1727	157
1727BA	188
1727BM	157
1728...	157
1728BA	188
1729	157
1729DM 450	158, 316
1729CG	158, 316
1729LR	158
1736A	158
1737	158
1737AC	158
1737B	158
1737BA	188
1737NX	158
1738	158
1739B	158
1740A	158
1740B	158
1741B	158, 316
1741B/C5	158
1741BP	159
1741RV...K	159
1741U	159, 317
1742	159
1742/C4	159
1742A	159
1742A/KR	160
1742A/C	160
1742KR	159
1742R-A/M...	159
1742R-AL/M...	159
1743	160
1743T	160
1748/C5	160
1748/...K	160
1748B/...K	160
1749	160
1749A	160
1749AC	160
1750	161
1750CG	161
1750M	161
1750R/1 - 1750R/2	161
1750RC	161
1750RP/1 - 1750RP/2	161
1750RT	161
1751	161
1751R	161
1752	161
1752R	161
1753	161
1753R	161
1754	161
1755	162
1756	162

Indice Alfanumerico

1756B	162
1757	162
1757A	162
1758	162
1759	162
1759A	162
1759B	162
1759HD/3	162
1759HD/RR	162
1760 400A	163
1760/2TM	165
1760/IR800	164
1760/IR1600	164
1760/RMS	163
1760/TC2	164
1760B	163
1760DGT	163
1760K/MT	163
1760PA/AC	164
1760PA/AC-DC	164
1760R/TC2	164
1761	165
1761RS/1	165
1762	165
1762K	317
1765/C24	165
1766	165
1766/8	165
1766A	165
1766G	165
1766I	165
1766L	165
1767PMC	165
1767PMR	165
1770	166
1770A	166
1770RL	166
1770BM	166, 317
1771	166, 317
1771BM	166, 317
1771RL	166
1772B	166
1772H	166
1772RL/2	166
1773A	166, 317
1773RL	166
1774	166
1774A	166
1774A/RL	166
1776BA	188
1777BM	166
1777MQ/C	179
1777MQ/U	179
1777RL/U	179
1777T	166, 317
1777BMT	167, 317
1778	167
1778D	167
1778SAFE	167
1778SOS	167
1778W	167
1778X	167
1779	167
1781	167
1783	167, 317
1784	167
1784BA	188
1800/100	167
1808	167
1812	167
1812E	167
1814M	168

1820/30 - 50 - 80	168
1822A/...	168
1823	168
1823/RS	168
1824R	168
1825ST250	168
1827	168
1827PC	168
1827PCL	168
1827PFL	168
1827/K	168
1830T	168
1834S	169
1834M	169
1834L	169, 317
1834XL	169
1835/1	169
1835/2	169
1836	169
1837	169, 317
1837E	169
1838/10LED	169
1838RV/10LED	169
1838LED/120	170
1838SL	170
1840BM	170
1840WBM	170
1841ABM	170
1841BM	170
1842XABM	170
1842XBM	170
1843BM	170
1843R/BM	170
1843R/WBM	170
1843WBM	170
1844ABM	171
1844BM	171
1844R/BM	171
1846XABM	171
1846XBM	171
1846R/XBM	171
1847P	171
1847K	171, 317
1848	171
1850B	171
1850C	172
1850U...	172
1851VK	172
1851VK-12C	172
1860R/C	172
1860K/140A	172
1860K/160A	172
1879	172
1880	172
1881	172
1882	172
1883	173
1883NC	173
1901/10	200
1901BM/8	200
1910	200
1914	200
1915B	200
1915C	201
1915C/L	201
1915D	201
1915E	201
1915E/XL	201
1916G	201
1916I	201
1917F	201
1917M	201

1917RS	201
1919F1/4	202
1919F1/2	202
1919FE1/4	201
1919L	202
1919ML	202
1919RB-F	202
1919RB-FE1/4	201
1919RF-F	202
1919RF-FE1/4	201
1919RM-F	202
1919RM-FE1/4	202
1919SC	202
1921B1	190
1921I	190
1921M1	190
1921M2	190
1921N3	190
1924B	190
1924CD	190
1927A	191
1927CD	191
1927DA	191
1927K4	191
1927MDA	191
1927P	191
1928CD	192
1928DA	192
1928DAL	192
1928K4	192
1930CD	192
1930HLA	193
1930LA	193
1930NCD	192
1930PA	193
1930ZL	193
1931AN10	194
1931CD6	193
1931CD10	193
1931CD13	194
1932B10	194
1932RS13	194
1933	194
1933AN90	195
1933I	194
1933IL	195
1933L	194
1934BV	195
1934MAV	195
1934MAV70	195
1935E	195
1935F	195
1936/5	196
1936/5A	196
1936/7	196
1937	196
1937R/P	196
1937N10	197
1937N10-GR	197
1937N20	197
1937N20-GR	197
1937M	196
1937M-01±11	196
1938	197
1938R/L	197
1938R/S5	197
1940	197
1940HD	197
1940MT	197
1940MT/HD	197
1940S...	197
1940/S5	198

1942	198
1942LR	198
1942S	198
1944	198
1944AR	198
1944L	198
1944L/RA	198
1946	198
1946C4,8	198
1946C7,8	199
1947	199
1948	199
1948PR	199
1949BC	199
1949BC/RU	199
1949DGT	200
1949F	199
1949G	199
1949GP	200
1949GPE	200
1949R/NIP	200
1949T	199
1995MQ/T	179
1995MQ/G1 - G2	184
2001/B26	204
2005PA/D	204
2005PA/S	204
2009ID	204
2009N/BV	204
2011/BV	204
2011ET	204
2014N/VU2	204
2014N/VV	204
2029/VV	204
2029E	204
2029/RT	205
2032E	205
2032/TE	205
2032/TV	205
2032/VV	205
2033E	205
2033N/VV	205
2034	205
2034/VV	205
2036E	206
2036/TV	205
2041UC	206
2051N	206
2055HB	206
2060/VV	206
2080/VV	206
2252	173
2252KR4	173
2300ST/KIT	211
2400S/PF	218
2499PC	220
2499PF	219
2499PF/M	219
2499PP/M	219
2499S-R/PC	218
3000M/LT	173
3000M/RLS	173
3000S/PLM	223
3002	173
3003	173
3009	173
3010/T...	174
3011/T	174
3012	174
3012I	174
3014	174
3014SAR	174

Indice Alfanumerico

3014SAR/1	174
3014SAR/2	174
3025	174
3026 0,5	174
3027	175
3027/KP	175
3030/2T	175
3030/2TRP	175
3040	175
3040A/1	175
3040A/2	175
3040A/6-8-10	175
3041	175
3041A/11	175
3041A/15	175
3042	175
3042/K6P	175
3043	175
3043A/41÷47	175
5700LAMP	243
5902MT	278
5902MT/AS	279
5902VI	250
5904VG/1M	280
5904VG/2T	281
5904VG/3	282
5904VG/5T	283
5904VI/1T	251
5904VI/2T	252
5904VI/3T	253
5904VU/1M	259
5904VU/2M	260
5904VU/3T	261
5905VG/1	284
5905VG/2	285
5908VG/2T	286
5908VI/2T	254
5910VG/3T	287
5910VI/3T	255
5915VU/0	261
5915VU/1	263
5915VU/2	264
5915VU/3	265
5915VU/4	266
5915VU/AS	267
5923VU/1T	268
5938U/2T	269
5940SBK	288
5953VG	289
5953VI	256
5954VG	290
5954VI	257
5957U	270
5957VG	291
5957VI	258
5958U	271
5980/MQ	274
5980EL/A	275
5980EL/B	276
5980ET/A	272
5980ET/B	273
5980ID	277
6600 E/A10	330
6600 E/A20	330
6600 E/A30	330
6600 E/B10	330
6600 E/B20	330
6600 E/C10	331
6600 E/D10	331
6600 E/E10	331
6600 E/K10	331
6600 E/K20	331

6600 E/P10	333
6600 M/10	323
6600 M/21	323
6600 M/27	323
6600 M/30	323
6600 M/38	323
6600 M/39	323
6600 M/40	323
6600 M/47	324
6600 M/51	324
6600 M/52	324
6600 M/58	324
6600 M/60	324
6600 M/63	324
6600 M/73	324
6600 M/74	324
6600 M/75	324
6600 M/112	324
6600 M/116	325
6600 M/120	325
6600 M/125	325
6600 M/131	325
6600 M/152	325
6600 M/163	325
6600 M/171	325
6600 M/216	325
6600 M/221	325
6600 M/230	325
6600 M/234	325
6600 M/241	325
6600 M/244	326
6600 M/247	326
6600 M/251	326
6600 M/311	326
6600 M/315	326
6600 M/320	326
6600 M/326	326
6600 M/327	326
6600 M/330	326
6600 M/370	326
6600 M/377	326
6600 M/417	327
6600 M/418	327
6600 M/427	327
6600 M/430	327
6600 M/440	327
6600 M/456	327
6600 M/464	327
6600 M/472	327
6600 M/480	327
6600 M/485	327
6600 M/510	327
6600 M/519	328
6600 M/525	328
6600 M/532	328
6600 M/542	328
6600 M/550	328
6600 M/561	328
6600 M/583	328
6600 M/617	328
6600 M/635	328
6600 M/650	328
6600 M/657	328
6600 M/658	328
6600 M/714	329
6600 M/724	329
6600 M/818	329
6600 M/824	329
6600 M/835	329
6800 VE	323
6888	323
7051MP	368

7061TC	368
7071BC	368
7071BD	368
7076BC	368
7076BD	368
7076BP	368
7091BC	368
7091BD	368
7093BC	368
7093BD	368
7190C	368
7195A	368
7200BKK	335
7201BKK	335
7205BKK	335
7206BKK	336
7208RK	337
7210BKK	336
7211BK	336
7216BKK	336
7239V	342
7240B	333
7241B	333
7242B	334
7243B	334
7243C	334
7245B	335
7246B	333
7247B	334
7250NKK	339
7251NKK	340
7252NKK	339
7254NA	338
7255NA	338
7263RK	338
7264RK	339
7290AKK	340
7291AKK	340
7293NKK	341
7293RK	340
7293TKK	341
7294NKK	341
7294RK	341
7294TKK	342
7295TNV	342
7300B	344
7300BKK	344
7310BKK	337
7313KK	345
7313KKB	345
7313KKC	345
7314KK	346
7316KK	347
7318ESD	345
7320KK	346
7326NKK	342
7327NKK	343
7327R	343
7328EA	343
7328EN	344
7329B	337
7330B	338
7330NV	343
7334KK	346
7344RP	347
7345RP	347
7346RP	348
7347RP	348
7348RP	349
7349RP	347
7350RP	348
7360BKK	349

7361DKK	349
7361GKK	349
7365GKK	350
7367G	350
7368BKK	351
7368GKK	351
7368NKK	350
7369BKK	351
7369GKK	352
7398 TNT	352
7398AL	353
7398BF	352
7398CX	352
7398GEL	352
7398ST	352
7399 A/N...	353
7399B...	353
7399G...	353
7399M...	353
7410	353
7413	353
7415	353
7416	353
7417	353
7418	355
7505B	355
7505DG	355
7505M	355
7515B	355
7515DG	355
7515M	356
7525	355
7546BL	356
7546G	356
7546N	356
7546O	356
7547BL	356
7547G	356
7548BL	356
7548G	356
7548N	357
7548O	357
7555	357
7575A	357
7577N	357
7578G	357
7622G	357
7632G	357
7634N	357
7635G	358
7635N	358
7641BL	358
7641G	358
7675N	358
7681BL	358
7682BL	358
7780N	358
7800G	367
7815N	359
7817N	359
7820	359
7821	359
7823	359
7825	359
7827	360
7829	360
7860E	360
7861E	360
7863E	360
7865E	360
7867E	361
7869E	361

Indice Alfanumerico

7870	361
7871	361
7873	361
7875	361
7877	362
7879	362
7900E	362
7901E	362
7903E	362
7904E	362
7905E	363
7907E	363
7909E	363
7910Y	363
7911Y	363
7913Y	363
7930	365
7930IP	364
7931	364
7933	365
7935	365
7937	365
7939	366
7970	366
7971E	366
7973	366
7978E	366
7979	366
7980	367
7981	367
7982B	368
7982G	367
7984	367
7991N	367
7992N	367
7993	367
7994	367
7995	367
8001TZ	372
8001Z	372
8002ZD	372
8002ZS	372
8003ZD	372
8003ZS	372
8004ND	372
8004NS	372
8005TZ	373
8005Z	373
8006Z	373
8007Z	373
8008N	373
8009FD	372
8009FS	373
8009Z	373
8010Z	373
8016	374
8016DA	374
8016DF	374
8016FR	374
8016U	374
8018E	374
8018T	375
8020	375
8021	375
8025	375
8026A	375
8028	376
8029	376
8029R	376
8030	376
8031	376
8040EN	377

8040EZ	376
8042EN	377
8042EZ	377
8044	377
8048	377
8049	377
8050D	380
8051S	379
8055S	379
8057	379
8058	379
8060	379
8061F	379
8062	380
8064S	380
8065SC	380
8074	377
8080	378
8085	380
8086	380
8090	380
8090F	381
8091	381
8092	382
8094	382
8096	382
8097	383
8098	383
8100	381
8105	374
8109	374
8114	378
8116	378
8150	383
8153	383
8156	383
8157	384
8158	384
8159	384
8160	384
8161	384
8166	385
8170	384
8173	384
8176	385
8177	385
8178	385
8180	385
8181	385
8182	385
8182S	385
8185	385
8186	386
8187	386
8188C	386
8188CG/25	386
8188F	386
8188F/35	386
8188FG2	386
8188FG3	386
8205	386
8206	387
8207	387
8209	387
8210	387
8216	387
8220	387
8225	387
8227	387
8228	387
8240	387
8240F	388

8242	388
8242F	388
8249	388
8250	388
8264	388
8267	388
8272	388
8273	388
8274	388
8274G	389
8276	389
8276G	389
8278	389
8280	389
8282	389
8284	389
8285	389
8286	389
8287	389
8290	389
8300	378
8302Z	378
8303Z	378
8317DZ	375
8317SZ	375
8345	378
8381SL	378
8381SP	378
8381SX	391
8383C	378
8383P	379
8515V	379
8515Z	379
8531	375
8532	376
8535	379
8600 E/R	330
8600 R/10	329
8600 R/111	329
8600 R/222	329
8600 R/411	329
9500	391
9501	391
9502	391
9504	391
9505	391
9510	391
9521	395
9525	395
9526	397
9527	397
9528	397
9530	395
9535	392
9536	392
9537	393
9539	396
9541	394
9544	394
9545	394
9546	397
9547	397
9551	393
9559	398
9569	399
9575	398
9581	398
9583	397
9586	398
9590	398
9594	398
9596	399

9503G	392
9508K	392
9519C	397
9519M	396
9519P	397
95210/OB	395
9522C	395
9524SC	397
9525/B	395
9525/ITA	395
9525/N	395
95290/B	397
9534B	393
9534W	393
9539C	396
9539G	396
9539P	396
9539R	396
9547WSK	397
9552J	393
9553J/L	394
9557J	394
9557N	394
9569P	399
9572GB	392
9572GC	392
9572GG	392
9572H	392
9572MB	391
9572Q	392
9574B	394
95740	394
9577F1	398
9579C	398
9582LE	398
9582LI	398
9588/10PI	399
9588S/10...	399
9588S/10...	399
9588S/10...	399
9588S/10...	399
9589A/36	399
9589B/36	399
9591S/...	399
9591S/...	399
9591S/...	399
9591S/...	399
9592P/P	398
9592S/50P	398
9593 Breil®	393
9593 Miami	393
9593CA	393
9595M/10	399
9595S/10P	399
9598WAP	396
9599CB	395
C1 - C2	307
C3 - C4	307
C5 - 2105	206
C6T - 2106	206
C9 - 2109	207
C9/RT	207
C10 - 2110	207
C10S - 2110S	207
C11 - 2111	207
C13	207
C15 - 2115	207
C15L - 2115L	207
C16 - 2116	207
CP17 - CP17L - 2117	208
C18 - 2118	208
C19 - 2119 - C19L - 2119L	208

Indice Alfanumerico

C20 - C20L - 2120	208
C22B	208
C22W	208
C22S - 2200S	209
C23SC - 2300SC	210
C23ST - 2300ST	210
CD23S	211
C24S/5 - 2400S5	213
C24S/6 - 2400S6	214
C24S/7 - 2400S7	215
C24S/8 - 2400S8	216
C24SA/7 - 2400SA7	217
C24SA-XL/7 - 2400SAXL7	218
C24SL - 2400SL	220
C25 - 2500	221
C28 - 2800	222
C30S - 3000S	222
C31	224
C38 - 3800	225
C38C	227
C38L	225
C38LA	225
C38T	226
C39/6 - 3900	228
C39/7 - 3900	229
C39/8 - 3900	230
C39/PM	230
C39/PU	231
C39MD - 3939MD	233
C39SM - 3939SM	232
C39T - 3900T	230
C41MS	235
C41S - 4100S	233
C41H - 4100H	234
C41H/CE	235
C42 MCH	236
C42H - 4200H	235
C42S - 4200S	234
C49	236
C51	237
CP52	237
CX52	237
C53 - 5300	239
C54 - 5400	240
C56	245
C56M	245
C57A - 5700A	240
C57B - 5700B	241
C57C	242
C57D	241
C57P - 5700P	242
C58A - 5800A	243
C58B - 5800B	244
C58C	244
C58M	245
C58M/PA	246
C58P/A - 5800UP/A	244
C58P/B - 5800UP/B	245
C59A - 5900A	246
C59B - 5900B	247
C59C - 5900C	249
C62	369
C62E/B	369
C62E/B2	369
C62E/D	369
C62EV/CP	369
C62M/W	369
C68	322
C68 G	322
C88 R/1	322
CB/2	308
GA	307

GA/C38-C	306
GA/C38-SX	306
GA/C38-DX	306
GA/C41	306
GL1 - GL2	307
GL3 - GL4	307
GM	308
KIT/GPS	307
MC10	291
MC82	291
MC91	291
MC131	291
MC153	291
MC220	291
M15	291
M16	292
M33	292
M38	292
M40	292
M45	292
M46	292
M50	292
M55	292
M63	292
M69	292
M75	292
M79	293
M82	293
M83	293
M85	293
M86	293
M91	293
M92	293
M112	293
M131	293
M132	293
M135	294
M145	294
M153	294
M170	294
M172	294
M174	294
M180	294
M199	294
M202	294
M204	294
M208	294
M220	294
M226	295
M227	295
M234	295
M236	295
M237	295
M240	295
M264	295
M285	295
M289	295
M300	295
M310	295
MB	307
S42/18	308
S55/8	308
S55/12	308
S951/6	308
S952	308
S 1719BM	308
SB	307
SGN	308
SL/C38	306
SL/C41	307
SL1 - SL2	307
SL3 - SL4	307

SP G9 - SP G11	308
ST1 - ST2	307
ST/C38-C	306
ST/C38-DX	306
ST/C38-SX	306
ST/C41	307
T10	296
T15	296
T16	296
T18	296
T19	296
T22	296
T31	296
T33	297
T34	297
T40	297
T41	297
T45	297
T46	297
T48	297
T50	297
T52	297
T53	297
T55	297
T56	298
T59	298
T63	298
T64	298
T65	298
T68	298
T73	298
T75	298
T75	298
T76	298
T77	298
T79	299
T80	299
T81	299
T82	299
T83	299
T85	299
T91	299
T92	299
T100	299
T101	299
T102	299
T103	300
T105	300
T106	300
T110	300
T112	300
T113	300
T120	300
T131	300
T132	300
T135	300
T136	300
T140	300
T142	301
T145	301
T146	301
T151	301
T153	301
T154	301
T155	301
T160	301
T161	301
T164	301
T167	301
T168	302
T170	302
T171	302

T172	302
T173	302
T175	302
T176	302
T177	302
T180	302
T183	302
T198	302
T199	302
T201	303
T202	303
T204	303
T205	303
T206	303
T207	303
T208	303
T209	303
T210	303
T212	303
T215	303
T220	304
T226	304
T227	304
T231	304
T233	304
T234	304
T236	304
T239	304
T241	304
T250	304
T256	305
T259	305
T264	305
T270	305
T273	305
T281	305
T286	305
T285	305
T289	305
T291	306
T296	306
TL1 - TL2	307
TL3 - TL4	307
TSPP	308
TV - TOV	307
VE1	307
VP1 - VP2	306
VP3 - VP4	306
VP-3SC	306
VP5	306
VP6	306
VP-LD	306
VP-LS	306



Condizioni generali di vendita

Gli ordini trasmessi per l'acquisto di prodotti dalla Beta Utensili SpA (d'ora in poi "Beta" o "Società") comportano l'accettazione automatica e senza riserve delle presenti Condizioni Generali di Vendita che costituiscono parte integrante del contratto di vendita. Eventuali deroghe alle stesse saranno efficaci solo se concordate per iscritto dalle parti e limitatamente alle vendite cui si riferiscono.

PRODOTTI

I pesi, le dimensioni, i prezzi, i colori e gli altri dati figuranti nei cataloghi, prospetti, circolari, od altri documenti illustrativi della Società, hanno carattere di indicazioni approssimative.

Beta si riserva di variare in qualsiasi momento, senza preavviso, i dati tecnici o costruttivi dei suoi prodotti.

ORDINI

Le presenti Condizioni Generali di Vendita si intendono approvate dall'acquirente con la trasmissione dell'ordine, ordine che viene ricevuto dalla Società sempre con la clausola "salvo approvazione della casa". Beta può accettare l'ordine mediante spedizione della merce, conformemente all'art. 1327 c.c..

Nell'ordine deve essere specificato il codice dell'articolo e la relative quantità.

Le quantità minime sono indicate nel listino per ciascun articolo. Ordini non corrispondenti ad esse, od ai loro multipli, verranno automaticamente adeguati senza previa autorizzazione al Cliente.

RIMANENZE

La Società si riserva la facoltà di evadere l'ordine tutto o in parte ovvero in diverse riprese. Nell'eventualità di ordini non completamente evasi Beta invierà tramite e-mail una distinta riepilogativa delle rimanenze di detti ordini che, salvo espressa richiesta contraria, saranno incluse nella o nelle spedizioni successive. Previa specifica richiesta del Cliente tali informazioni verranno trasmesse via fax.

TERMINI DI CONSEGNA

Eventuali termini di consegna, comunque e dovunque previsti, avranno valore puramente indicativo. La Società declina ogni responsabilità per il caso di ritardo nella consegna che non derivi da suo dolo o colpa grave. Il mancato rispetto dei termini di consegna, purché contenuto in un ragionevole lasso di tempo, non dà diritto al Cliente di richiedere un risarcimento, né di annullare gli Ordini, a meno che, avuto riguardo alla normale tollerabilità ed alla natura del contratto ed alla fornitura, la stessa non abbia più importanza per il Cliente. In questo caso l'onere probatorio sarà a carico del Cliente stesso.

Salvo il caso di dolo o colpa grave della Società, è espressamente escluso qualsiasi risarcimento del danno per mancata o ritardata consegna dei prodotti.

GESTIONE ORDINI, SPEDIZIONI E IMBALLI

Le spedizioni sono effettuate franco destino, con mezzi di trasporto a scelta della Società per gli ordini netti superiori ad € 600,00.

Per gli ordini inferiori ad € 600,00 verrà addebitato a titolo di contributo spese di trasporto il seguente importo:

contributo fisso di € 10,00 fino ad € 199,99

contributo pari al 3,50% da € 200,00 ad € 599,99.

L'imballo è gratuito quando non richiesto di tipo particolare.

Il trasferimento dei rischi relativi ai prodotti ha luogo al momento della loro consegna al Vettore: conseguentemente, i prodotti viaggiano a rischio e pericolo del destinatario anche in caso di spedizione porto franco.

L'Acquirente che sia già cliente abituale potrà rivolgersi direttamente al **Deposito Beta di Milano** anche per quantità diverse dall'unità di confezionamento previste. Il costo del servizio verrà addebitato nella misura forfetaria del 6% in sede di fatturazione e le spese di spedizione saranno a carico del Cliente.

PREZZI

L'indicazione di prezzo contenuta in cataloghi, listini, ecc. è meramente indicativa e potrà quindi subire variazioni senza necessità di preventiva informazione. Salvo diverso accordo tra le parti, la merce sarà fatturata ai prezzi in vigore al momento della spedizione.

I prezzi si intendono al netto di iva, di eventuali imposte o tasse, nonché di tributi, diritti ed oneri fiscali o di qualsiasi specie eventualmente gravanti sul contratto che restano a carico esclusivo del Cliente.

PAGAMENTI

Il pagamento deve essere corrisposto direttamente presso la sede della Società in Via Volta n. 18 - 20845 SOVICO (MB) ovvero alla persona munita di autorizzazione scritta con le modalità e nei termini indicati nella fattura.

Sconti per pagamenti a breve termine vanno calcolati sull'importo netto della merce, escluso imballo, spese postali o di trasporto e iva. Trascorsi 15 giorni dalla data della fattura o dal periodo concordato, si intende revocato il beneficio dello sconto condizionato e pertanto la rimessa andrà effettuata per il totale della fattura.

Il ritardato pagamento rispetto alla data pattuita darà luogo all'addebito degli interessi di mora di cui all'art. 5 del D.Lgs. 231/02 e produrrà la perdita per il Cliente del beneficio del termine ai sensi dell'art. 1186 cod. civ., rendendo immediatamente esigibili eventuali somme non ancora scadute.

Il Cliente non è autorizzato ad effettuare alcuna deduzione dal prezzo pattuito (ad es. in caso di pretesi difetti dei prodotti), se non previo accordo scritto con la Società.

GARANZIA

I prodotti venduti da Beta sono garantiti in relazione a vizi o difetti di fabbricazione; la garanzia è limitata alla sostituzione o riparazione dei prodotti riconosciuti difettosi presso la sede della Società, con esclusione di qualsiasi diritto al risarcimento dei danni. La suddetta garanzia non si applica a prodotti che presentano normale usura, segni di manomissione o di uso improprio. Le spese di trasporto dei prodotti da sostituire o riparare e dei prodotti sostituiti o riparati sono a carico dell'Acquirente. In presenza dei presupposti di cui al comma precedente Beta sostituirà o riparerà gratuitamente il Prodotto riscontrato difettoso all'origine se reso franco sede della Società con relativo documento di trasporto sul quale dovranno essere indicati, oltre alla dicitura merce difettosa, gli estremi della fattura emessa all'atto della vendita.

Salvo il caso di dolo o colpa grave, la Società sarà tenuta, in caso di vizi o mancanza di qualità dei prodotti, unicamente alla riparazione o sostituzione dei prodotti difettosi. È inteso che la suddetta garanzia (consistente nell'obbligo di riparare o sostituire i prodotti) comprende e sostituisce ogni garanzia o responsabilità della Società (sia contrattuale che extracontrattuale) comunque originata dai prodotti forniti (ad es. risarcimento del danno, mancato guadagno ecc.).

RECLAMI

Il Cliente deve denunciare gli eventuali vizi e difetti dei prodotti forniti o l'eventuale mancata o difforme fornitura di tutto o parte dell'Ordine d'Acquisto, a pena di decadenza, entro il termine di 8 (otto) giorni da calcolarsi rispettivamente dalla data di consegna dei prodotti (vizi apparenti) e/o da quella della scoperta dei vizi o difetti (vizi occulti). Nel caso di vizi palesi la denuncia dovrà essere fatta per iscritto a mezzo di lettera raccomandata a.r..

Eventuali contestazioni non danno diritto al Cliente di sospendere o comunque ritardare i pagamenti dei prodotti oggetto di contestazione né, tanto meno, di altre forniture.

La garanzia non opera nel caso in cui l'Acquirente abbia eseguito o fatto eseguire interventi da parte di terzi sui prodotti, senza il preventivo consenso scritto di Beta. La merce difettosa, qualora non presenti inconvenienti dovuti a normale logorio, errato uso o evidente manomissione, verrà riparata o sostituita gratuitamente solo se restituita in porto franco presso la sede della Società, indicando nel documento di accompagnamento la causale e gli estremi della fattura relativa.

RESI

Eventuali resi di merce vengono accettati solo se preventivamente concordati e autorizzati per iscritto; contrariamente saranno rispediti al mittente con trasporto a proprio carico.

In ogni caso nel documento di accompagnamento devono essere indicati la causale del reso ed il numero di autorizzazione ricevuto.

Tali resi dovranno essere inviati presso la sede della Società in Via Volta n. 18 - 20845 SOVICO (MB).

FORO COMPETENTE

Le presenti Condizioni Generali di Vendita sono regolate dalle leggi della Repubblica Italiana. Per tutto quanto non espressamente regolato dalle presenti condizioni, sarà applicata la normativa del codice civile.

Per qualsiasi controversia derivante dal contratto di vendita disciplinati dalle presenti Condizioni Generali di Vendita o ad esso collegata sarà esclusivamente competente il Foro di Monza, fatte comunque salve diverse inderogabili norme di legge.

Condizioni generali di vendita

Gli ordini trasmessi per l'acquisto di prodotti Robur dalla Beta Utensili SpA (d'ora in poi "Beta" o "Società") devono essere inviati alla nostra sede produttiva di Sulmona e comportano l'accettazione automatica e senza riserve delle presenti Condizioni Generali di Vendita che costituiscono parte integrante del contratto di vendita. Eventuali deroghe alle stesse saranno efficaci solo se concordate per iscritto dalle parti e limitatamente alle vendite cui si riferiscono.

PRODOTTI

I pesi, le dimensioni, i prezzi, i colori e gli altri dati figuranti nei cataloghi, prospetti, circolari, od altri documenti illustrativi della Società, hanno carattere di indicazioni approssimative.

Beta si riserva di variare in qualsiasi momento, senza preavviso, i dati tecnici o costruttivi dei suoi prodotti.

ORDINI

Le presenti Condizioni Generali di Vendita si intendono approvate dall'acquirente con la trasmissione dell'ordine, ordine che viene ricevuto dalla Società sempre con la clausola "salvo approvazione della casa". Beta può accettare l'ordine mediante spedizione della merce, conformemente all'art. 1327 c.c..

Nell'ordine deve essere specificato il codice dell'articolo e la relative quantità.

Le quantità minime sono indicate nel listino per ciascun articolo. Ordini non corrispondenti ad esse, od ai loro multipli, verranno automaticamente adeguati senza previa autorizzazione al Cliente.

RIMANENZE

La Società si riserva la facoltà di evadere l'ordine tutto o in parte ovvero in diverse riprese. Nell'eventualità di ordini non completamente evasi Beta invierà tramite e-mail una distinta riepilogativa delle rimanenze di detti ordini che, salvo espressa richiesta contraria, saranno incluse nella o nelle spedizioni successive. Previa specifica richiesta del Cliente tali informazioni verranno trasmesse via fax.

TERMINI DI CONSEGNA

Eventuali termini di consegna, comunque e dovunque previsti, avranno valore puramente indicativo. La Società declina ogni responsabilità per il caso di ritardo nella consegna che non derivi da suo dolo o colpa grave. Il mancato rispetto dei termini di consegna, purché contenuto in un ragionevole lasso di tempo, non dà diritto al Cliente di richiedere un risarcimento, né di annullare gli Ordini, a meno che, avuto riguardo alla normale tollerabilità ed alla natura del contratto ed alla fornitura, la stessa non abbia più importanza per il Cliente. In questo caso l'onere probatorio sarà a carico del Cliente stesso.

Salvo il caso di dolo o colpa grave della Società, è espressamente escluso qualsiasi risarcimento del danno per mancata o ritardata consegna dei prodotti.

GESTIONE ORDINI, SPEDIZIONI E IMBALLI

Le spedizioni sono effettuate franco destino con addebito delle spese in fattura con mezzi di trasporto a scelta della Società.

L'imballo è gratuito quando non richiesto di tipo particolare.

Il trasferimento dei rischi relativi ai prodotti ha luogo al momento della loro consegna al Vettore: conseguentemente, i prodotti viaggiano a rischio e pericolo del destinatario anche in caso di spedizione porto franco.

L'Acquirente che sia già cliente abituale potrà rivolgersi direttamente al **Deposito Beta di Milano** anche per quantità diverse dall'unità di confezionamento previste. Il costo del servizio verrà addebitato nella misura forfetaria del 6% in sede di fatturazione e le spese di spedizione saranno a carico del Cliente.

PREZZI

L'indicazione di prezzo contenuta in cataloghi, listini, ecc. è meramente indicativa e potrà quindi subire variazioni senza necessità di preventiva informazione. Salvo diverso accordo tra le parti, la merce sarà fatturata ai prezzi in vigore al momento della spedizione.

I prezzi si intendono al netto di iva, di eventuali imposte o tasse, nonché di tributi, diritti ed oneri fiscali o di qualsiasi specie eventualmente gravanti sul contratto che restano a carico esclusivo del Cliente.

PAGAMENTI

Il pagamento deve essere corrisposto direttamente presso la sede della Società in Via Volta n. 18, 20845 Sovico (MB) ovvero alla persona munita di

autorizzazione scritta con le modalità e nei termini indicati nella fattura.

Sconti per pagamenti a breve termine vanno calcolati sull'importo netto della merce, escluso imballo, spese postali o di trasporto e iva. Trascorsi 15 giorni dalla data della fattura o dal periodo concordato, si intende revocato il beneficio dello sconto condizionato e pertanto la rimessa andrà effettuata per il totale della fattura.

Il ritardato pagamento rispetto alla data pattuita darà luogo all'addebito degli interessi di mora di cui all'art. 5 del D.Lgs. 231/02 e produrrà la perdita per il Cliente del beneficio del termine ai sensi dell'art. 1186 cod. civ., rendendo immediatamente esigibili eventuali somme non ancora scadute.

Il Cliente non è autorizzato ad effettuare alcuna deduzione dal prezzo pattuito (ad es. in caso di pretesi difetti dei prodotti), se non previo accordo scritto con la Società.

GARANZIA

I prodotti venduti da Beta sono garantiti in relazione a vizi o difetti di fabbricazione; la garanzia è limitata alla sostituzione o riparazione dei prodotti riconosciuti difettosi presso la sede della Società, con esclusione di qualsiasi diritto al risarcimento dei danni. La suddetta garanzia non si applica a prodotti che presentano normale usura, segni di manomissione o di uso improprio. Le spese di trasporto dei prodotti da sostituire o riparare e dei prodotti sostituiti o riparati sono a carico dell'Acquirente. In presenza dei presupposti di cui al comma precedente Beta sostituirà o riparerà gratuitamente il Prodotto riscontrato difettoso all'origine se reso franco sede della Società con relativo documento di trasporto sul quale dovranno essere indicati, oltre alla dicitura merce difettosa, gli estremi della fattura emessa all'atto della vendita.

Salvo il caso di dolo o colpa grave, la Società sarà tenuta, in caso di vizi o mancanza di qualità dei prodotti, unicamente alla riparazione o sostituzione dei prodotti difettosi. È inteso che la suddetta garanzia (consistente nell'obbligo di riparare o sostituire i prodotti) comprende e sostituisce ogni garanzia o responsabilità della Società (sia contrattuale che extracontrattuale) comunque originata dai prodotti forniti (ad es. risarcimento del danno, mancato guadagno ecc.).

RECLAMI

Il Cliente deve denunciare gli eventuali vizi e difetti dei prodotti forniti o l'eventuale mancata o difforme fornitura di tutto o parte dell'Ordine d'Acquisto, a pena di decadenza, entro il termine di 8 (otto) giorni da calcolarsi rispettivamente dalla data di consegna dei prodotti (vizi apparenti) e/o da quella della scoperta dei vizi o difetti (vizi occulti). Nel caso di vizi palesi la denuncia dovrà essere fatta per iscritto a mezzo di lettera raccomandata a.r..

Eventuali contestazioni non danno diritto al Cliente di sospendere o comunque ritardare i pagamenti dei prodotti oggetto di contestazione né, tanto meno, di altre forniture.

La garanzia non opera nel caso in cui l'Acquirente abbia eseguito o fatto eseguire interventi da parte di terzi sui prodotti, senza il preventivo consenso scritto di Beta. La merce difettosa, qualora non presenti inconvenienti dovuti a normale logorio, errato uso o evidente manomissione, verrà riparata o sostituita gratuitamente solo se restituita in porto franco presso la sede della Società, indicando nel documento di accompagnamento la causale e gli estremi della fattura relativa.

RESI

Eventuali resi di merce vengono accettati solo se preventivamente concordati e autorizzati per iscritto; contrariamente saranno rispediti al mittente con trasporto a proprio carico.

In ogni caso nel documento di accompagnamento devono essere indicati la causale del reso ed il numero di autorizzazione ricevuto.

Tali resi dovranno essere inviati presso la sede produttiva della Società in Zona Industriale - Contrada S. Nicola - 67039 SULMONA (AQ).

FORO COMPETENTE

Le presenti Condizioni Generali di Vendita sono regolate dalle leggi della Repubblica Italiana. Per tutto quanto non espressamente regolato dalle presenti condizioni, sarà applicata la normativa del codice civile.

Per qualsiasi controversia derivante dal contratto di vendita disciplinati dalle presenti Condizioni Generali di Vendita o ad esso collegata sarà esclusivamente competente il Foro di Monza, fatte comunque salve diverse inderogabili norme di legge.



MARIO POVIA
VALLE D'AOSTA
PIEMONTE: Torino
 Cell. 338.4372521
 Fax 011.2620433
 mario.povia@aliceposta.it

ALESSANDRO DE SANCTIS
LIGURIA
PIEMONTE: Alessandria, Asti, Cuneo
 Cell. 348.3008699
 Fax 019.90085
 alessanc@libero.it

ROBERTO RADAELLI
LOMBARDIA NORD OVEST: Provincia Nord Milano, Monza
PIEMONTE: Novara, Vercelli, Biella
 Tel. 039.2010558
 Cell. 337.756200
 Fax 039.2015252
 roal2003@tiscali.it

ALBERTO RADAELLI
LOMBARDIA NORD OVEST: Como, Sondrio, Varese
PIEMONTE: Verbano-Cusio-Ossola
 Tel. 039.2010558
 Cell. 368.946851
 Fax 039.2015252
 roal2003@tiscali.it

LUIGI FUMAGALLI SAS
LOMBARDIA SUD OVEST: Lodi, Pavia, Milano città, provincia Sud Milano
 Tel. 02.4078792
 Cell. 335.214487
 Fax 039.570186
 lfrappresentanze@tiscalinet.it

AVIDANO SIMEONI
LOMBARDIA NORD EST: Provincia Est Milano, Bergamo, Lecco
 Cell. 335.5296941
 Fax 02.45500738
 ufficio@avidanosimeoni.it

MARCO VESENTINI
LOMBARDIA SUD EST: Brescia, Mantova, Cremona
VENETO: Verona
 Cell. 346.0831683
 Fax 0376.809741
 marcovesentini@tiscali.it

TARGA SERGIO & C. SAS
TRENTINO ALTO ADIGE
VENETO: Vicenza
 Cell. 348.4112065
 Fax 0461.530550
 targa_s70@yahoo.it

NICOLA MION
VENETO: Padova, Rovigo, Belluno, Treviso, Venezia
 Cell. 335.8427204
 Fax 0422.452468
 n.mion@virgilio.it

MAURO BARBOTTI & C. SAS
FRIULI VENEZIA GIULIA
 Cell. 338.4070716
 Fax 040.830630
 maurobarbotticisas@gmail.com

RAMS DI MIRKO SPOTO
EMILIA ROMAGNA: Modena, Parma, Reggio Emilia, Piacenza
 Tel. 051.8659116
 Cell. 335.6767165
 Fax 051.6646204
 info@ramsmirkospoto.it
 mirkospoto@libero.it

RIEM - MARCO MALAGUTI
EMILIA ROMAGNA: Bologna, Ferrara, Ravenna, Forlì-Cesena, Rimini
 Tel. 051.0411533
 Cell. 335.5488324
 Fax 051.0411519
 info@nuovariem.com

STEFANO CAMERINI
TOSCANA: Firenze, Pistoia, Prato, Livorno, Pisa, Lucca, Massa Carrara
 Cell. 347.5084765
 Fax 055.289350
 camerini.stefano@tiscali.it

GABBI S.A.S. DI GABBI PAOLO & C.
TOSCANA: Grosseto, Siena, Arezzo
UMBRIA
 Cell. 348.7105920 (Paolo)
 Cell. 335.6549612 (Simone)
 Fax 0575.351998
 gabbis@libero.it
 gabbip@tiscalinet.it

ALEX CAPPANERA
MARCHE - REP. SAN MARINO
 Cell. 339.4718269
 Fax 0731.205528
 alex@cappanera.it

MAURO BISOGNINI
ABRUZZO - MOLISE
 Tel. 071.2862055
 Fax 071.2863155
 info@maurobisognini.it - www.maurobisognini.it

DANIELE MARINELLI
LAZIO
 Tel. 06.8177774 - 06.8183359
 Cell. 335.5394617
 Fax 06.8181378
 marinelliagenzia@tiscali.it

ANTONINO SCOGNAMIGLIO
CAMPANIA: Benevento, Caserta, Napoli Nord
 Cell. 335.5281534
 Fax 081.2140299
 antonino.scognamiglio@fastwebnet.it

ESPOSITO RAPPRESENTANZE
CAMPANIA: Avellino, Salerno, Napoli Sud
BASILICATA: Potenza
 Cell. 335.6212740
 Fax 081.2140299
 alfredo-esposito@fastwebnet.it

GIOVANNI PEPE
PUGLIA
BASILICATA: Matera
 Cell. 393.3334452
 Fax 080.5497786
 giovanni.pepe@hotmail.com

DOMENICO ARAGONA
CALABRIA
 Cell. 337.872220
 Fax 0984.465320
 aragonadomenico@virgilio.it

SALVATORE TUDISCO
SICILIA EST: Messina, Catania
 Cell. 335.8064374
 Fax 095.2937744
 info@agenziatudisco.it

RITA ITALIA
SICILIA EST: Siracusa, Ragusa, Enna
 Cell. 338.6365091
 Fax 0931.870400
 ritaitalia@gmail.com

BETA UTENSILI S.p.A.
 Sicilia Ovest
 Tel. 039.2077.1
 Fax 039.2010742
 info@beta-tools.it

PICO - LUCIANO COMPARETTI
SARDEGNA: Oristano, Cagliari, Carbonia-Iglesias, Medio Campidano
 Cell. 349.4977448
 Fax 070.513150
 pico.comparetti@tiscali.it

PICO - SALVATORE PILLA
SARDEGNA: Sassari, Nuoro, Ogliastra, Olbia-Tempio
 Cell. 349.4977449
 Fax 079.501493
 pico.pilla@tiscali.it



MARIO POVIA
VALLE D'AOSTA
PIEMONTE: Torino
 Cell. 338.4372521
 Fax 011.2620433
 mario.povia@aliceposta.it

ALESSANDRO DE SANCTIS
LIGURIA
PIEMONTE: Alessandria, Asti, Cuneo
 Cell. 348.3008699
 Fax 019.90085
 alessanc@libero.it

ROBERTO RADAELLI
LOMBARDIA NORD OVEST: Provincia Nord Milano, Monza
PIEMONTE: Novara, Vercelli, Biella
 Tel. 039.2010558
 Cell. 337.756200
 Fax 039.2015252
 roal2003@tiscali.it

ALBERTO RADAELLI
LOMBARDIA NORD OVEST: Como, Sondrio, Varese
PIEMONTE: Verbano-Cusio-Ossola
 Tel. 039.2010558
 Cell. 368.946851
 Fax 039.2015252
 roal2003@tiscali.it

LUIGI FUMAGALLI SAS
LOMBARDIA SUD OVEST: Lodi, Pavia, Milano città, provincia Sud Milano
 Tel. 02.4078792
 Cell. 335.214487
 Fax 039.570186
 lfrappresentanze@tiscalinet.it

AVIDANO SIMEONI
LOMBARDIA NORD EST: Provincia Est Milano, Bergamo, Lecco
 Cell. 335.5296941
 Fax 02.45500738
 ufficio@avidanosimeoni.it

MARCO VESENTINI
LOMBARDIA SUD EST: Brescia, Mantova, Cremona
VENETO: Verona
 Cell. 346.0831683
 Fax 0376.809741
 marcovesentini@tiscali.it

TARGA SERGIO & C. SAS
TRENTINO ALTO ADIGE
VENETO: Vicenza
 Cell. 348.4112065
 Fax 0461.530550
 targa_s70@yahoo.it

NICOLA MION
VENETO: Padova, Rovigo, Belluno, Treviso, Venezia
 Cell. 335.8427204
 Fax 0422.452468
 n.mion@virgilio.it

MAURO BARBOTTI & C. SAS
FRIULI VENEZIA GIULIA
 Cell. 338.4070716
 Fax 040.830630
 maurobarbotticsas@gmail.com

RAMS DI MIRKO SPOTO
EMILIA ROMAGNA: Modena, Parma, Reggio Emilia, Piacenza
 Tel. 051.8659116
 Cell. 335.6767165
 Fax 051.6646204
 info@ramsmirkospoto.it
 mirkospoto@libero.it

RIEM - MARCO MALAGUTI
EMILIA ROMAGNA: Bologna, Ferrara, Ravenna, Forlì-Cesena, Rimini
 Tel. 051.0411533
 Cell. 335.5488324
 Fax 051.0411519
 info@nuovariem.com

STEFANO CAMERINI
TOSCANA: Firenze, Pistoia, Prato, Livorno, Pisa, Lucca, Massa Carrara
 Cell. 347.5084765
 Fax 055.289350
 camerini.stefano@tiscali.it

GABBI S.A.S. DI GABBI PAOLO & C.
TOSCANA: Grosseto, Siena, Arezzo
UMBRIA
 Cell. 348.7105920 (Paolo)
 Cell. 335.6549612 (Simone)
 Fax 0575.351998
 gabbis@libero.it
 gabbip@tiscalinet.it

ALEX CAPPANERA
MARCHE - REP. SAN MARINO
 Cell. 339.4718269
 Fax 0731.205528
 alex@cappanera.it

FRANCESCO BIBONE
ABRUZZO - MOLISE
 Cell. 338.4576367
 Fax 085.2058663
 fbibone@yahoo.it

DANIELE MARINELLI
LAZIO
 Tel. 06.8177774 - 06.8183359
 Cell. 335.5394617
 Fax 06.8181378
 marinelliagenzia@tiscali.it

ANTONINO SCOGNAMIGLIO
CAMPANIA: Benevento, Caserta, Napoli Nord
 Cell. 335.5281534
 Fax 081.2140299
 antonino.scognamiglio@fastwebnet.it

ESPOSITO RAPPRESENTANZE
CAMPANIA: Avellino, Salerno, Napoli Sud
BASILICATA: Potenza
 Cell. 335.6212740
 Fax 081.2140299
 alfredo-esposito@fastwebnet.it

FRANCESCO PEPE
PUGLIA
BASILICATA: Matera
 Cell. 329.7955353
 Fax 080.5497786
 francesco.pepe@hotmail.com

DOMENICO ARAGONA
CALABRIA
 Cell. 337.872220
 Fax 0984.465320
 aragonadomenico@virgilio.it

SALVATORE TUDISCO
SICILIA EST: Messina, Catania
 Cell. 335.8064374
 Fax 095.2937744
 info@agenziaitudisco.it

RITA ITALIA
SICILIA EST: Siracusa, Ragusa, Enna
 Cell. 338.6365091
 Fax 0931.870400
 ritaItalia@gmail.com

BETA UTENSILI S.p.A.
 Sicilia Ovest
 Tel. 039.2077.1
 Fax 039.2010742
 info@beta-tools.it

PI.CO - LUCIANO COMPARETTI
SARDEGNA: Oristano, Cagliari, Carbonia-Iglesias, Medio Campidano
 Cell. 349.4977448
 Fax 070.513150
 pico.comparetti@tiscali.it

PI.CO - SALVATORE PILLA
SARDEGNA: Sassari, Nuoro, Ogliastra, Olbia-Tempio
 Cell. 349.4977449
 Fax 079.501493
 pico.pilla@tiscali.it



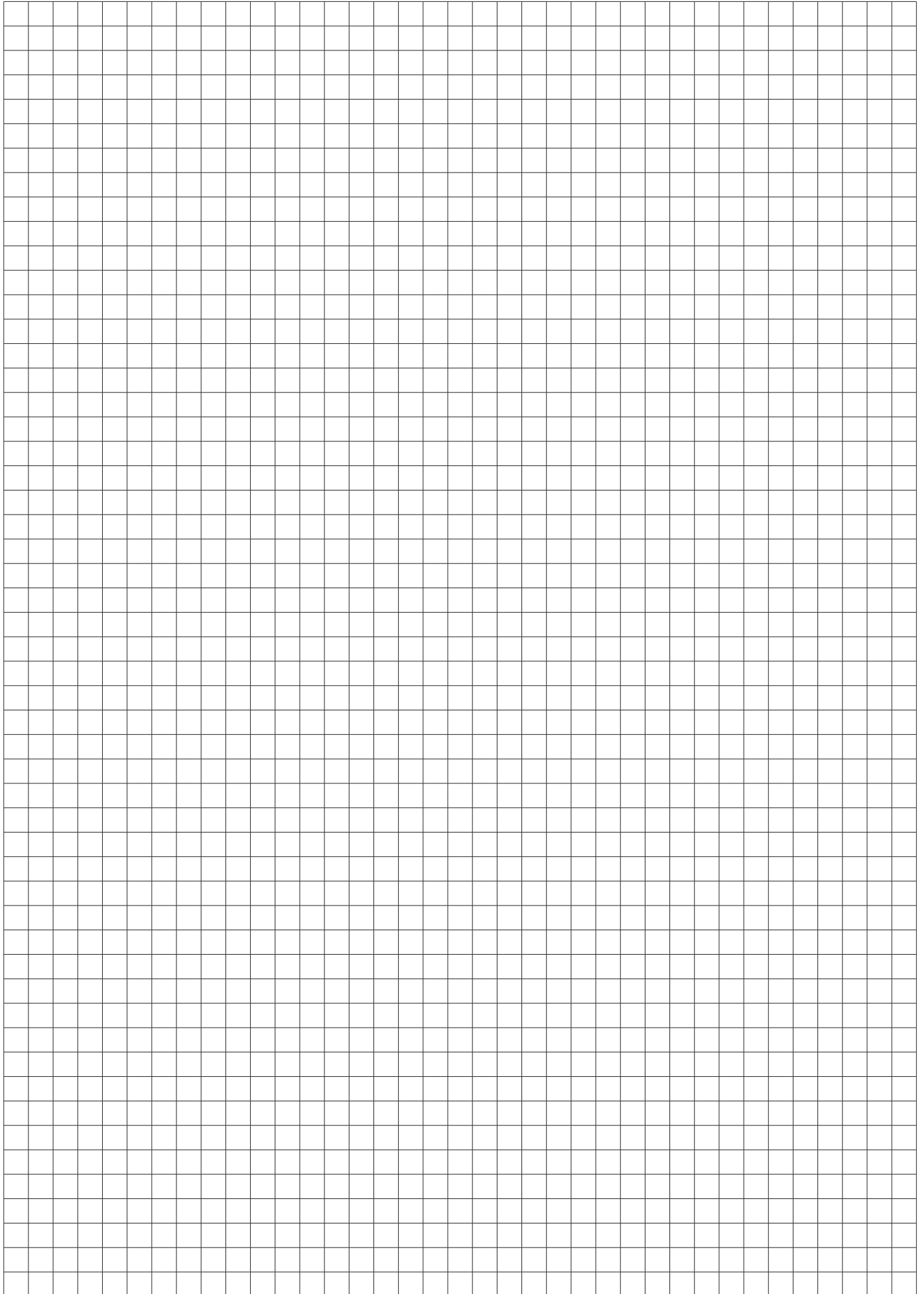

Beta 2014

The screenshot shows the Beta website homepage with the following elements:

- Header:** Beta logo and "Professional Hand Tools". Language dropdown set to "Italiano".
- Navigation:** Catalogo, Novità, Promozioni, Download, **Beta su facebook**, Il gruppo Beta, Motorsport, Contatti.
- Banner:** "Beta Action" with a hand cursor pointing to it.
- Product Grid:** Sollevatori, Estrattore reversibile, Estrattore 2 in 1 Diesel Common Rail, Avvitatore reversibile, Sollevi, and "Banchi da lavoro Endurance".
- Media:** VIDEO section with a "ciclo di produzione / art. 42" video, and "Beta WEEK" promotional images.
- Footer:** "ALTRI MARCHI BETA" (Beta WEEK, Robur, Beta, Beta Shop), "CONTATTI BETA ITALIA" (Offices in Export, Commercial, Marketing, and Technical), "BETA NEL MONDO" (Brazil, Spain, France, Great Britain, Netherlands, P.R. China, Poland), and "AREA NEWS" (Email, Password).

www.beta-tools.it





2013 partnership



Valentino Rossi



Graphic cover by Enzo Herrera



2013 partnership



Beta

Official Sponsor MotoGP 2013

YAMAHA

Valentino Rossi

998068200



8 014230 736297

Graphic cover by Enzo Herrera