

Come assemblare la MODULAR 1 orizzontale

How to assemble horizontal MODULAR 1

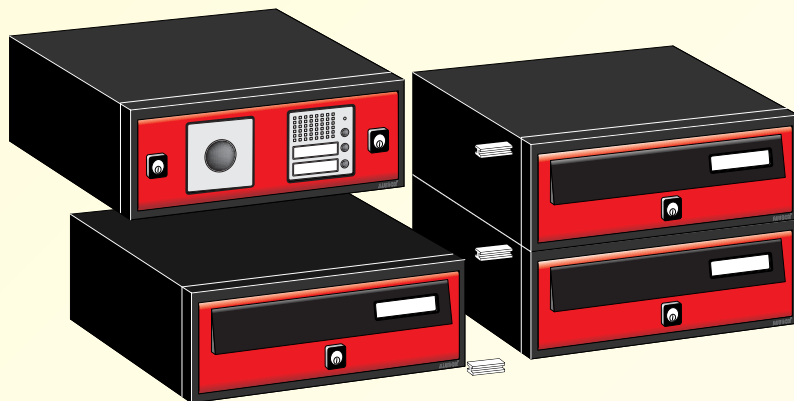

Composizione con mantello per esterni
Set with outer casing for outdoor installation

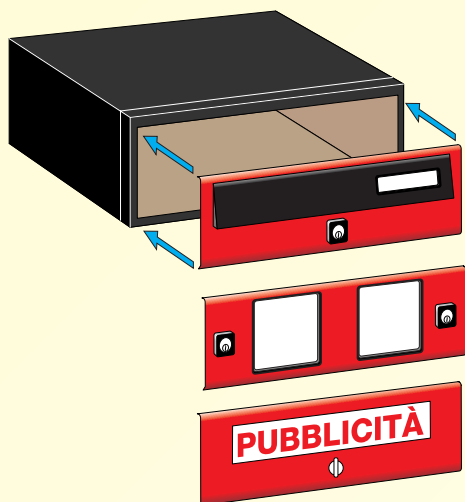
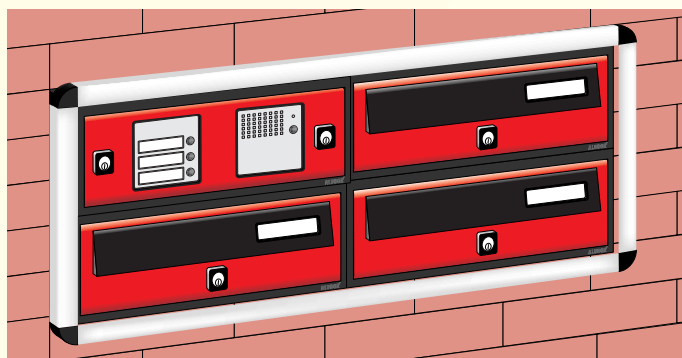

Composizione da incasso con cornice coprifuga
Recess mounting set with cover frame

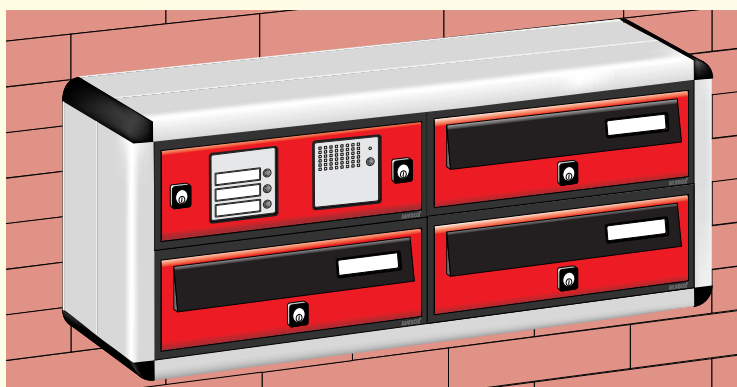

Composizione semincasso con mantello
Set with outer casing for semi-recess mounting

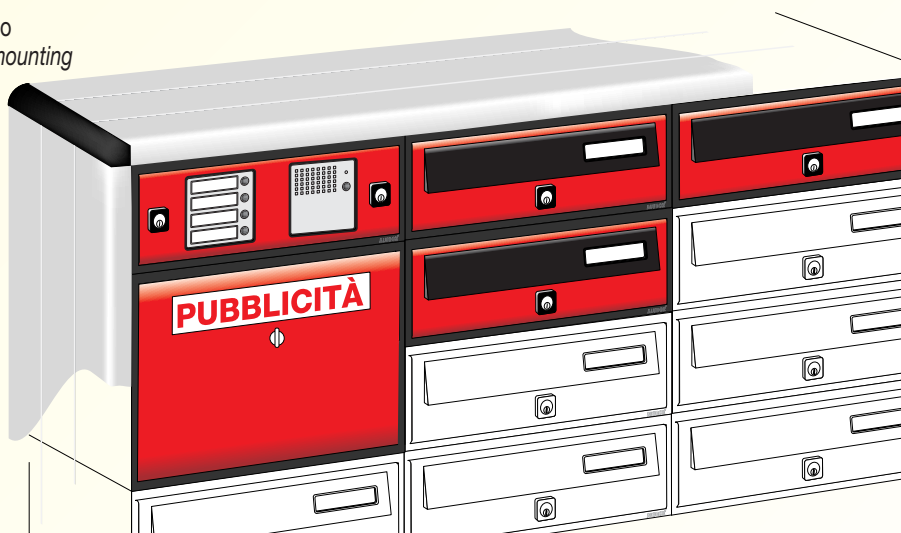

Serie MODULAR 1 orizzontale

RIVISTA

INTERNO

ESTERNO con mantello

INCASSO

COMPONIBILE

Made in Italy

MODELLO CONFORME NORME EUROPEE
EN 13724

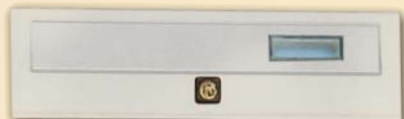

SPORTELLO MODULAR SP1

(confezione 6 pezzi)

Sportello universale per Modular C1, completo di elemento mobile. In profilato d'alluminio:

- anodizzato argento
- anodizzato bronzo
- verniciato nero
- verniciato rosso RAL 3003 con elemento mobile nero
- verniciato verde RAL 6005 con elemento mobile nero
- verniciato bianco RAL 9016
- verniciato ghisa con elemento mobile nero

Tutta la Serie MODULAR viene fornita con corpo e sportelli smontati.

DOOR MODULAR SP1

(6-pc package)

Universal door for Modular C1, complete with flap. In aluminium, available in the following finishes:

- anodised silver
- anodised bronze
- painted in black
- painted in RAL 3003 red with black flap
- painted in RAL 6005 green with black flap
- painted in RAL 9016 white
- painted cast-iron grey with black flap

The entire MODULAR series is supplied with body and doors not assembled.

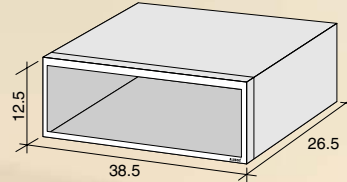

MODULAR C1 per SP1

(confezione da 6 pezzi)

Corpo per cassetta componibile in **alluminio** elettro colore testa di moro.

MODULAR C1 for SP1

(6-pc package)

Body for modular mailbox in **ANODISED DARK BROWN aluminium**.



Modular 1 Completa
Modular 1 - Complete set

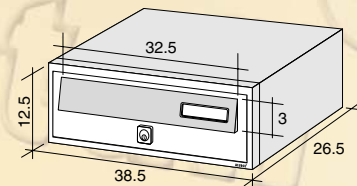

MODULAR C1F per SP1

(confezione da 6 pezzi)

Corpo per cassetta componibile in **lamiera elettrozincata**.

MODULAR C1 F for SP1

(6-pc package)

Body for modular mailbox in **electro galvanised sheet steel**.

MODULAR C1F per SP1

Sportello SP - OTT

Sportello in alluminio con elemento mobile in ottone.

Door SP - OTT

Aluminium door with brass flap.

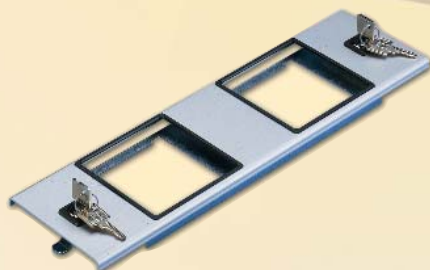

Sportello SP1 ACC

Sportello Serie MODULAR in profilato d'alluminio predisposto per l'inserimento di campanelli, telecamera, citofono e numero civico per i modelli Terraneo Sfera.

Altri modelli vedi da pag. M22. **Finiture: vedi SP1**

Door SP1 ACC

MODULAR series door in aluminium profile designed for incorporating doorbells, video camera, intercom and residence number for models Terraneo Sfera.

Other models, see from page M22. **Types of Finish: see SP1**



CORPO MODULAR C1 + SP1 PUB

(confezione da 1 pezzo)

Corpo completo di sportello per pubblicità.

BODY FOR MODULAR C1 + SP1 PUB

(1-pc package)

Body complete with adhesive name plate for advertising.

CORPO MODULAR C1 + SP1 PUB

(confezione da 1 pezzo)

Corpo doppio completo di sportello per pubblicità.

BODY FOR MODULAR C1 + SP1 PUB

(1-pc package)

Double body complete with adhesive name plate for advertising.



Come assemblare la MODULAR 1 verticale

How to assemble vertical MODULAR 1

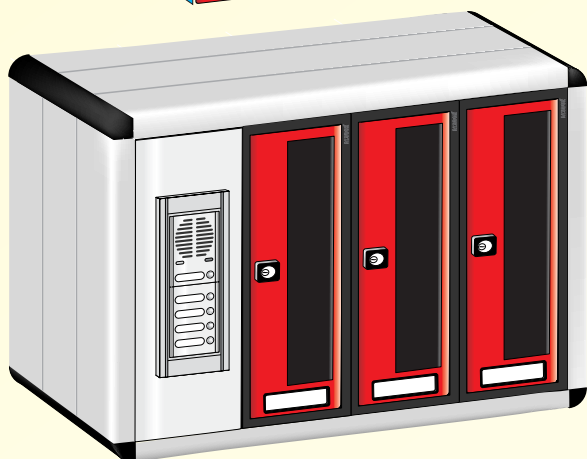
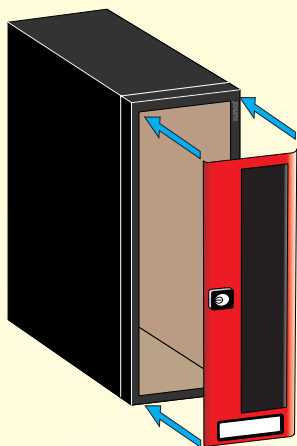

Composizione con mantello
Set with outer casing

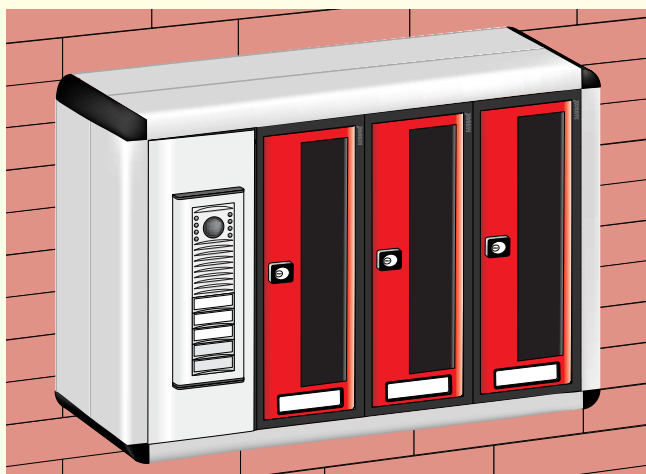

Composizione semincasso con mantello
Set with outer casing for semi-recess mounting

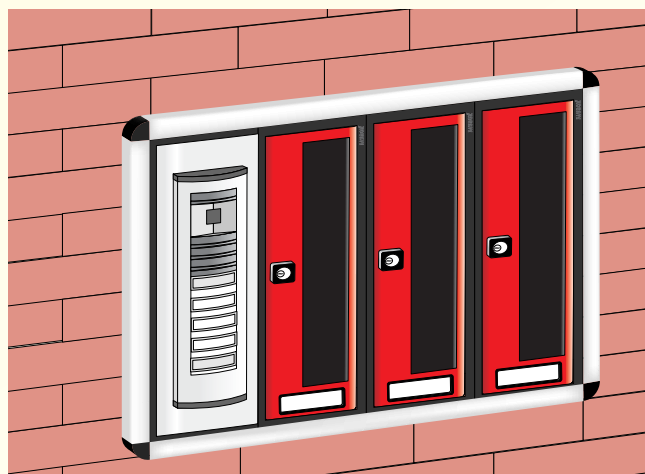

Composizione incasso con cornice coprifuga
Recess mounting set with cover frame



Serie MODULAR 1 verticale

RIVISTA

INTERNO

ESTERNO
con mantello

INCASSO

COMPONIBILE

Made in Italy

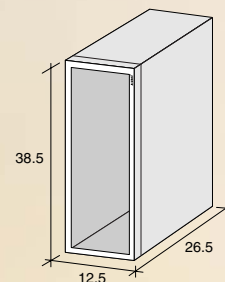

SPORTELLO MODULAR SP1V

(confezione 6 pezzi)

Sportello universale per Modular C1, completo di elemento mobile.

In profilato d'alluminio:

- anodizzato argento
- anodizzato bronzo
- verniciato nero
- verniciato rosso RAL 3003 con elemento mobile nero
- verniciato verde RAL 6005 con elemento mobile nero
- verniciato bianco RAL 9016
- verniciato ghisa con elemento mobile nero

MODULAR C1 per SP1V

(confezione da 6 pezzi)

Corpo per cassetta componibile in **alluminio** elettro colore testa di moro.

MODULAR C1 for SP1V

(6-pc package)

Body for modular mailbox in **ANODISED DARK BROWN aluminium**.

MODULAR C1F per SP1V

(confezione da 6 pezzi)

Corpo per cassetta componibile in **lamiera elettrozincata**.

MODULAR C1F for SP1V

(6-pc package)

Body for modular mailbox in **electrogalvanised sheet steel**.



Tutta la Serie MODULAR viene fornita con corpo e sportelli smontati.

DOOR MODULAR SP1V

(6-pc package)

Universal door for Modular C1, complete with flap. In aluminium, available in the following finishes:

- anodised silver
- anodised bronze
- painted in black
- painted in RAL 3003 red with black flap
- painted in RAL 6005 green with black flap
- painted in RAL 9016 white
- painted cast-iron grey with black flap

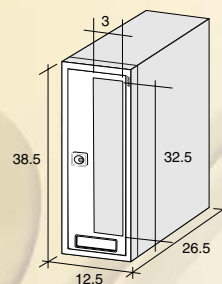

Modular 1V Completa
Modular 1V - Complete set

The entire MODULAR series is supplied with body and doors not assembled.

Accessori per citofoni, campanelli e videocitofoni da pagina M22.

Accessories for intercoms, doorbells and video telephone entry systems, see from page M22.

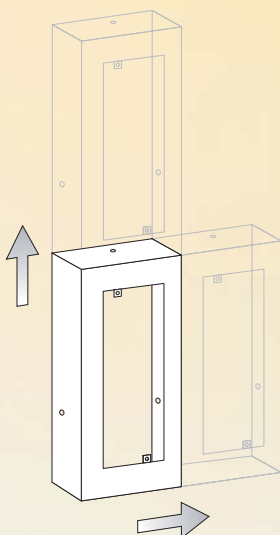

Placca porta accessori - Accessories holding plate



Come assemblare la MODULAR 2 orizzontale

How to assemble horizontal MODULAR 2

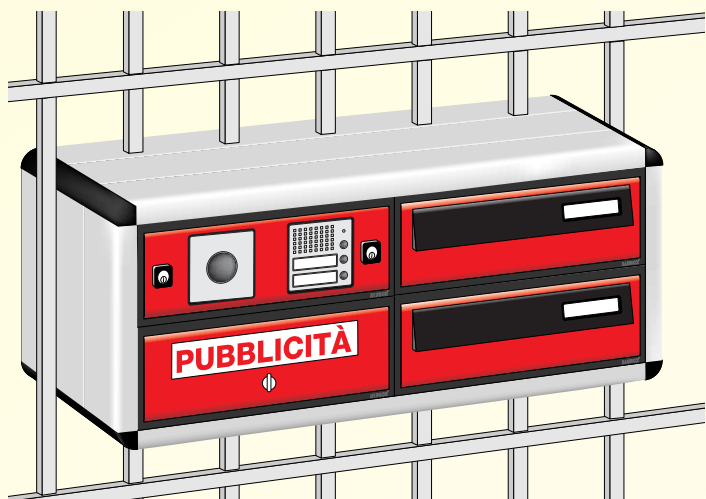
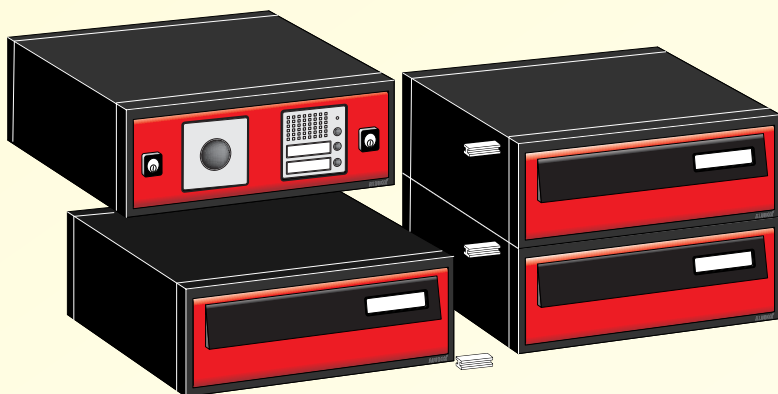
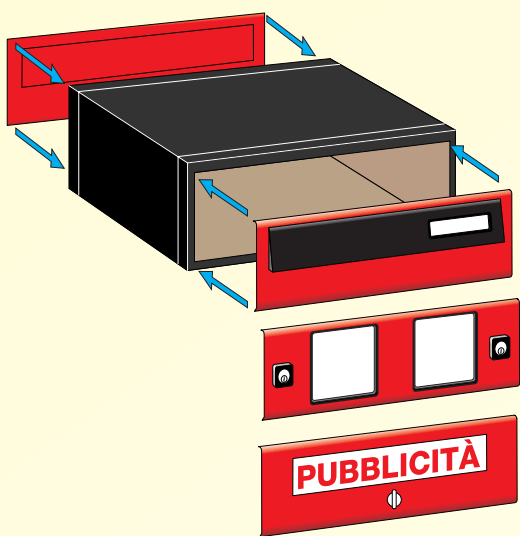

Composizione con mantello da recinzione
Set with outer casing for fence mounting

Composizione da incasso con cornice
Recess mounting set with frame

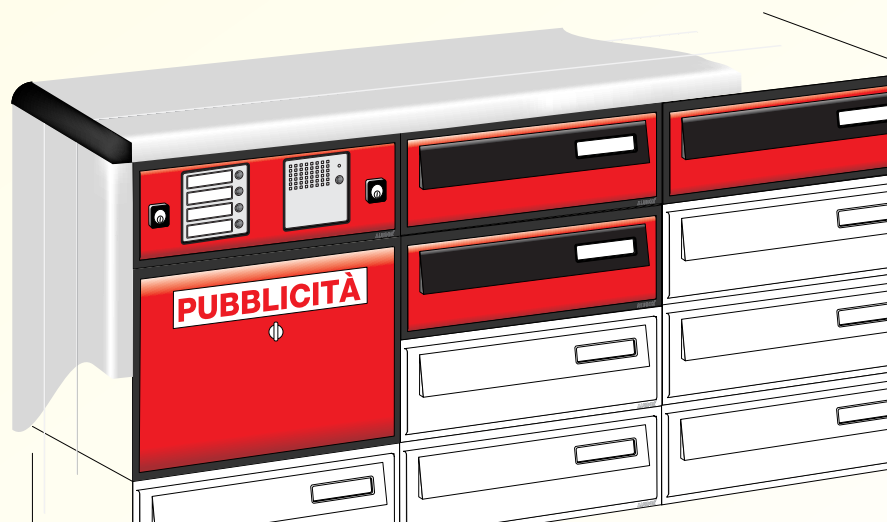
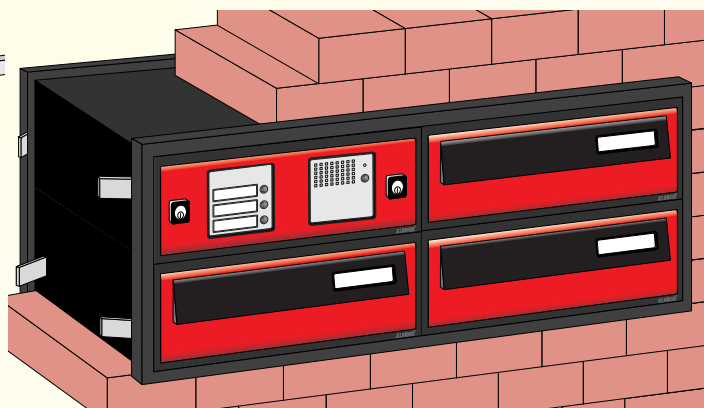

Serie MODULAR 2 orizzontale

RIVISTA

INTERNO

ESTERNO
con mantello

INCASSO

COMPONIBILE

Made in Italy

MODELLO CONFORME NORME EUROPEE

EN 13724

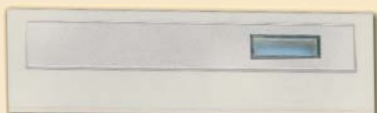

Sportello SP - OTT

Sportello in alluminio con elemento mobile in ottone.

Door SP - OTT

Aluminium door with brass flap.



MODULAR 2 ACC

Cassetta completa bifrontale da incasso passante, in alluminio elettro colore testa di moro e sportello porta accessori predisposto per l'inserimento di campanelli, telecamera, citofono e numero civico per i modelli Terraneo Sfera. Altri modelli vedi da pag. M22.

MODULAR 2 ACC

Finiture: vedi sportello Modular 2
Complete through mounting double-sided mailbox, in dark black oxi-anodised aluminium and accessories holding door designed for incorporating doorbells, video camera, intercom and residence number for models TerraneoSfera.

Other models, see from page M22.
Types of Finish: see Modular 2 door

SPORTELLO MODULAR SP2F

(confezione 6 pezzi)

Sportello universale per Modular 2, completo di elemento mobile. In profilato d'alluminio:

- anodizzato argento
- anodizzato bronzo
- verniciato nero
- verniciato rosso RAL 3003 con elemento mobile nero
- verniciato verde RAL 6005 con elemento mobile nero
- verniciato bianco RAL 9016
- verniciato ghisa con elemento mobile nero

SP2R

- sportello retro finiture come per SP2F

Tutta la Serie MODULAR viene fornita con corpo e sportelli smontati.

DOOR MODULAR SP2F

(6-pc package)

Universal door for Modular 2, complete with flap. In aluminium, available in the following finishes:

- anodised silver
- anodised bronze
- painted in black
- painted in RAL 3003 red with black flap
- painted in RAL 6005 green with black flap
- painted in RAL 9016 white
- painted cast-iron grey with black flap

SP2R

- rear door with same finishes SP2F

The entire MODULAR series is supplied with body and doors not assembled.



SP2F - Frontale
Front door



SP2R - Retro
Rear door



CORPO MODULAR C2 + SP2 PUB

(confezione da 1 pezzo)

Corpo completo di sportello per pubblicità.

BODY FOR MODULAR C2 + SP1 PUB

(1-pc package)

Body complete with adhesive name plate for advertising.



Modular 2 Completa
Modular 2 Complete set

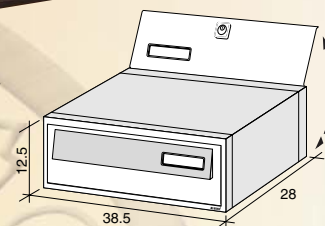

MODULAR C2

(confezione da 6 pezzi)

Corpo cassetta componibile bifrontale da incasso passante, in **alluminio** elettro colore testa di moro.

MODULAR C2F

(6-pc package)

Body for double-sided mailbox for wall mounting in dark brown **anodised aluminium**.

MODULAR C2F

Corpo cassetta componibile bifrontale da incasso passante, in **lamiera elettrozincata**.

MODULAR C2F

Body for double-sided mailbox for wall mounting in **electrogalvanised sheet steel**.



CORPO MODULAR C2 + SP2 PUB

(confezione da 1 pezzo)

Corpo doppio completo di sportello per pubblicità

BODY FOR MODULAR C2 + SP1 PUB

(1-pc package)

Double body complete with adhesive name plate for advertising.

Come assemblare la MODULAR 2 verticale
How to assemble vertical MODULAR 2

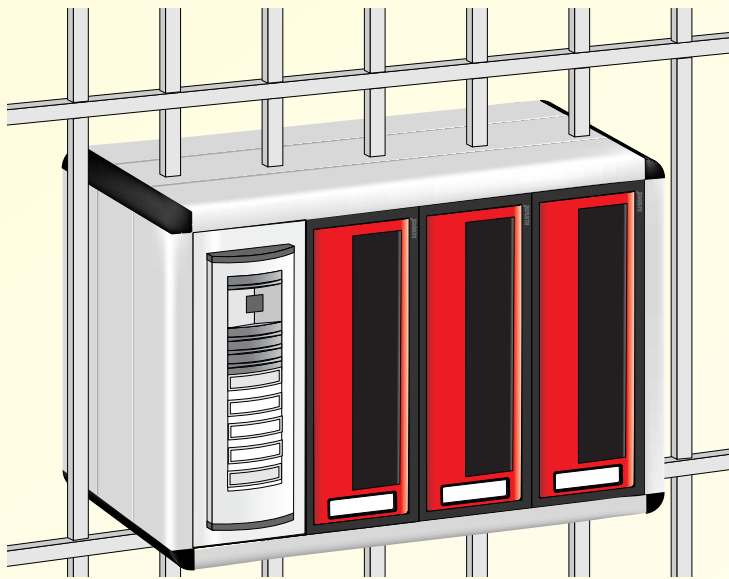
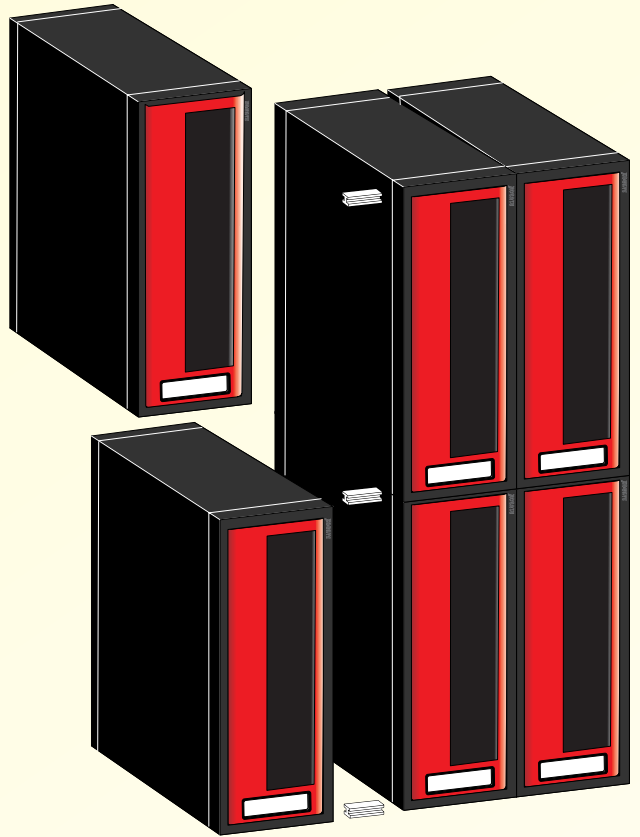
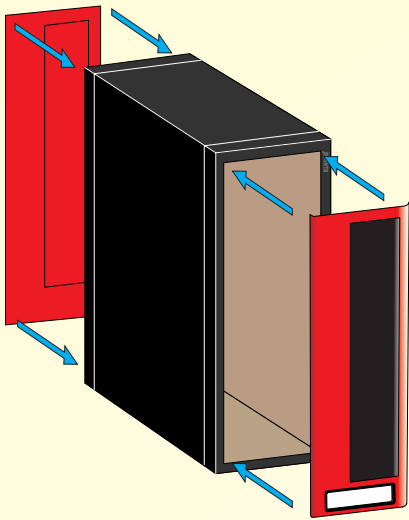

Composizione con mantello da recinzione
Set with outer casing for fence mounting

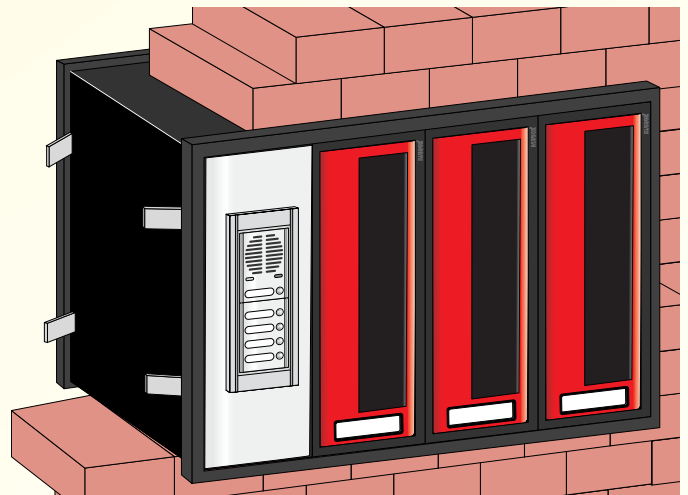
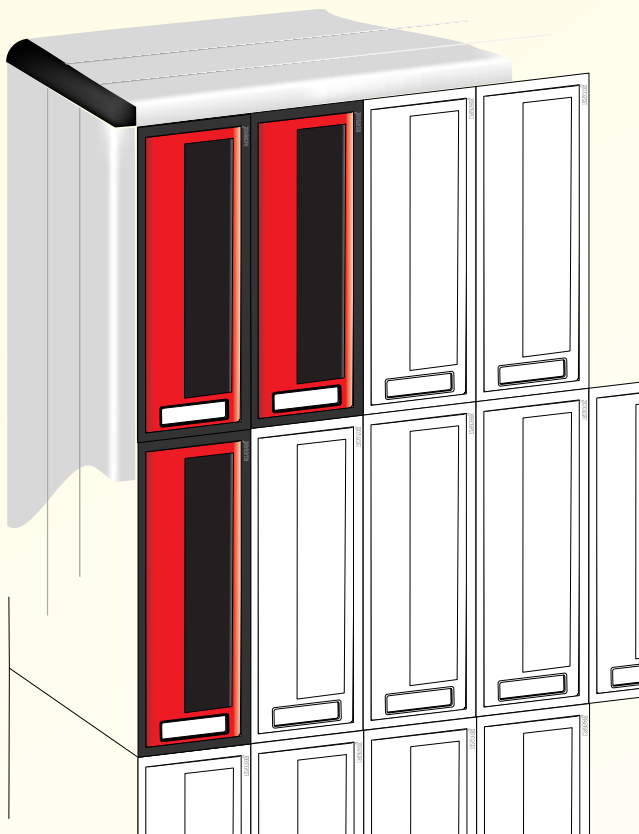

Composizione da incasso con cornice
Recess mounting set with frame

Serie MODULAR 2 verticale

RIVISTA

INTERNO

ESTERNO
con mantello

INCASSO

COMPONIBILE

Made in Italy



Modular 2V Completa
Modular 2V Complete set



SPORTELLO MODULAR SP2VF

(confezione 6 pezzi)

Sportello universale per Modular C2, completo di elemento mobile.

In profilato d'alluminio:

- anodizzato argento
- anodizzato bronzo
- verniciato nero
- verniciato rosso RAL 3003 con elemento mobile nero
- verniciato verde RAL 6005 con elemento mobile nero
- verniciato bianco RAL 9016
- verniciato ghisa con elemento mobile nero



SP2VR

- sportello retro finiture come per SP2VF

Tutta la Serie MODULAR viene fornita con corpo e sportelli smontati.

DOOR MODULAR SP2VF

(6-pc package)

Universal door for Modular C2, complete with flap. In aluminium, available in the following finishes:

- anodised silver
- anodised bronze
- painted in black
- painted in RAL 3003 red with black flap
- painted in RAL 6005 green with black flap
- painted in RAL 9016 white
- painted cast-iron grey with black flap

SP2VR

- rear door with same finishes SP2VF

The entire MODULAR series is supplied with body and doors not assembled.

Accessori per citofoni, campanelli e videocitofoni da pagina M22.

Accessories for intercoms, doorbells and video telephone entry systems, see from page M22.

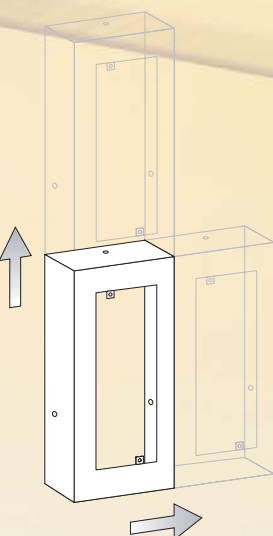

Placca porta accessori
Accessories holding plate



MODULAR C2

(confezione da 6 pezzi)

Corpo cassetta componibile bifrontale da incasso passante, in **alluminio** elettro colore testa di moro.

MODULAR C2

(6-pc package)

Body for double-sided mailbox for wall mounting in dark brown **anodised aluminium**.

MODULAR C2F

Corpo cassetta componibile bifrontale da incasso passante, in **lamiera elettrozincata**.

MODULAR C2F

Body for double-sided mailbox for wall mounting in **electrogalvanised sheet steel**.



SP2VR - Retro - Rear door



SP2VF - Frontale - Front door

Come assemblare la MODULAR 2T

How to assemble MODULAR 2T

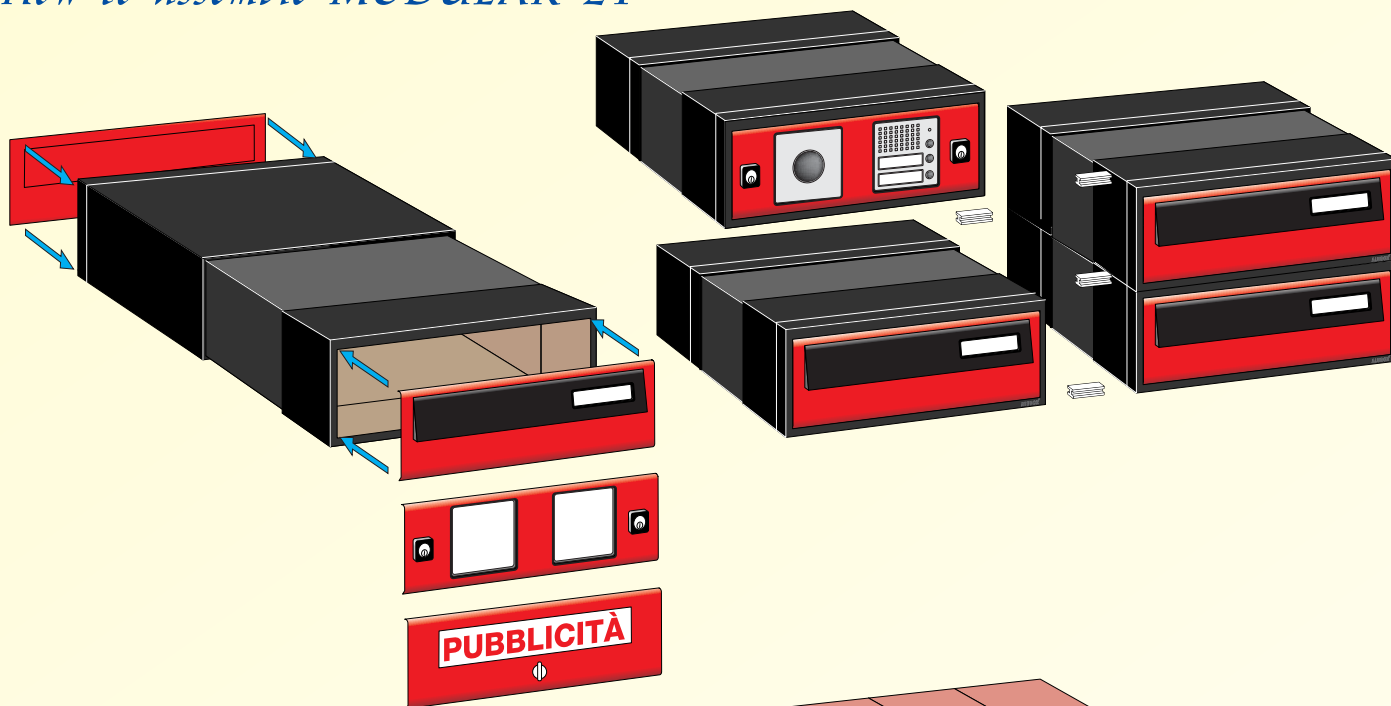

Composizione da incasso
con cornice coprifuga
Recess mounting set with
cover frame

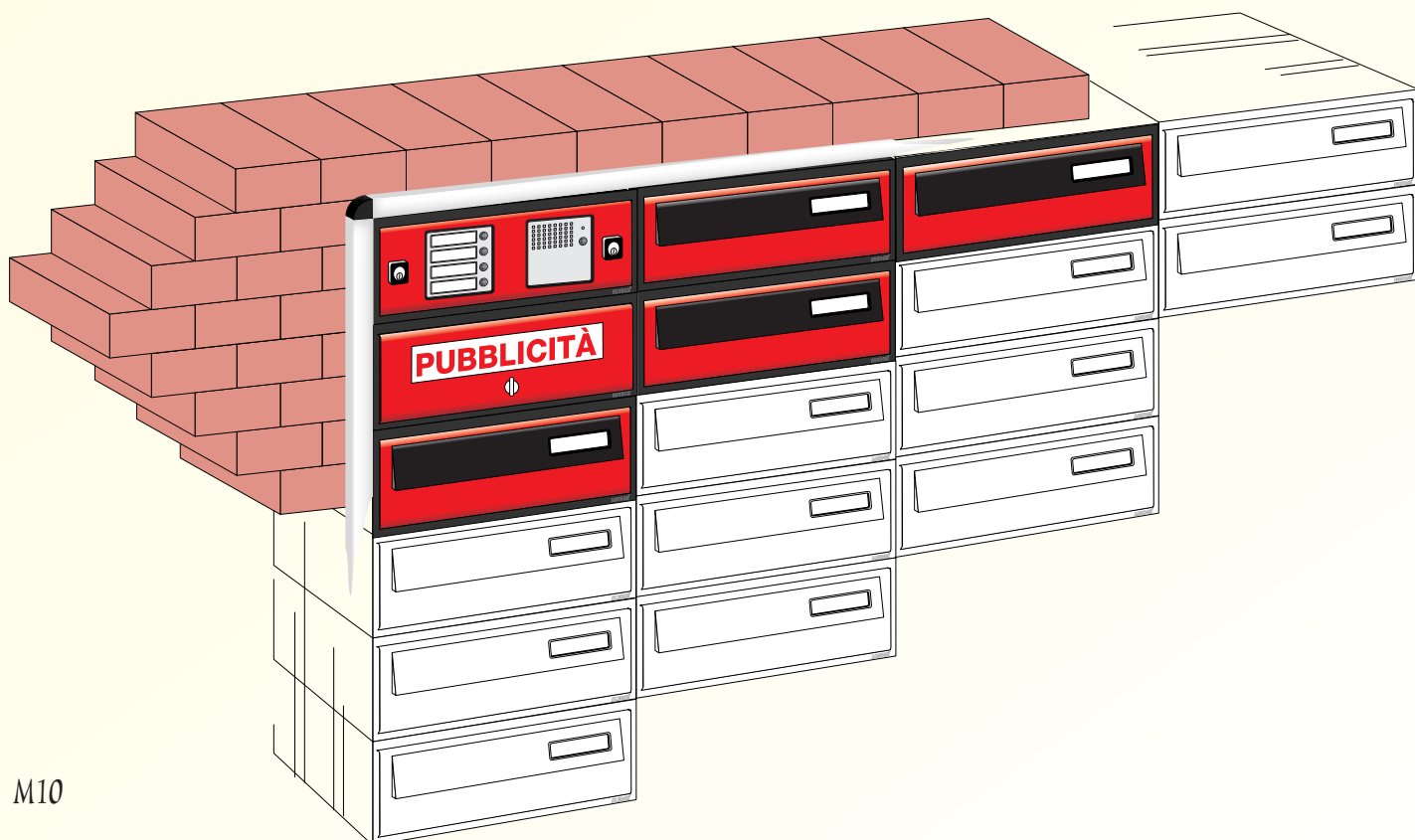
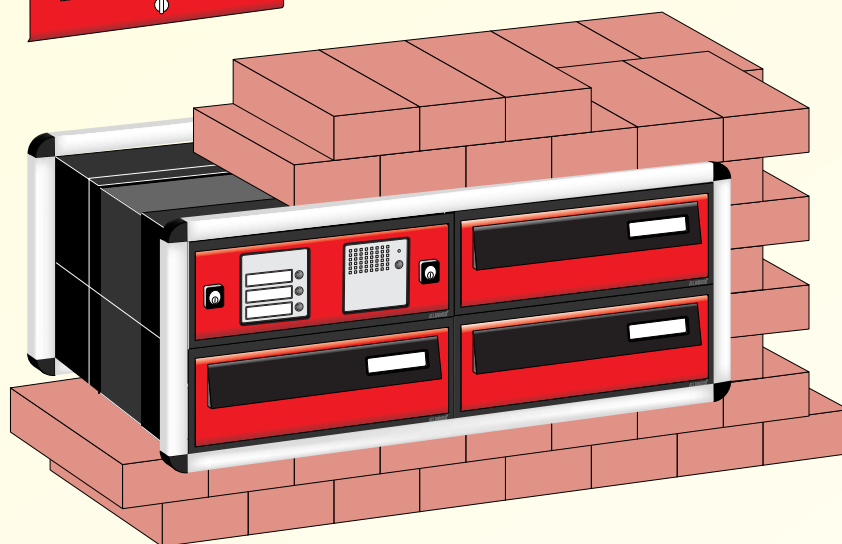

RIVISTA

INTERNO

ESTERNO

INCASSO

COMPONIBILE

Made in Italy

MODELLO CONFORME NORME EUROPEE

EN 13724



SPORTELLO MODULAR 2T

(confezione 6 pezzi)

Sportello universale per Modular 2T, completo di elemento mobile. In profilo d'alluminio:

- anodizzato argento
- anodizzato bronzo
- verniciato nero
- verniciato rosso RAL 3003 con elemento mobile nero
- verniciato verde RAL 6005 con elemento mobile nero
- verniciato bianco RAL 9016 con elemento mobile nero
- verniciato ghisa con elemento mobile nero

Tutta la Serie MODULAR viene fornita con corpo e sportelli smontati.

DOOR MODULAR 2T

(6-pc package)

Universal door for Modular 2T, complete with flap. In aluminium, available in the following finishes:

- anodised silver
- anodised bronze
- painted in black
- painted in RAL 3003 red with black flap
- painted in RAL 6005 green with black flap
- painted in RAL 9016 white
- painted cast-iron grey with black flap

The entire MODULAR series is supplied with body and doors not assembled.

Sportello SP - OTT

Sportello in alluminio con elemento mobile in ottone.

Door SP - OTT

Aluminium door with brass flap.



MODULAR 2T + SP1 PUB

(confezione da 1 pezzo)

Corpo completo di sportello per pubblicità.

MODULAR 2T + SP1 PUB

(1-pc-package)

Body complete with adhesive name plate for advertising.



Modular 2 T Completa
Modular 2 T Complete set

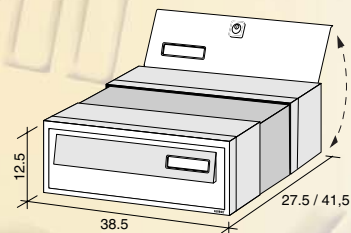

MODULAR 2 ACC

Cassetta completa bifrontale da incasso passante, in alluminio elettro colore testa di moro e sportello porta accessori predisposto per l'inserimento di campanelli, telecamera, citofono e numero civico per i modelli Terraneo Sfera. Altri modelli vedi da pag. M22. **Finiture: vedi sportello Modular 2T**

MODULAR 2 ACC

Complete through mounting double-sided mailbox, in dark black oxi-anodised aluminium and accessories holding door designed for incorporating doorbells, video camera, intercom and residence number for models Terraneo Sfera. Other models, see from page M22. **Types of Finish: see Modular 2T door**



Modular Telescopica:

cassetta bifrontale da incasso con corpo a profondità variabile: da un minimo di cm 27,5 a un massimo di cm 43 di spessore del muro.

Modular Telescopica:

two-sided recess mounted mail box with body of varying depth suitable for a wall depth ranging from 27.5 cm to 43 cm.

Come assemblare la MODULAR 2 verticale
How to assemble vertical MODULAR 2

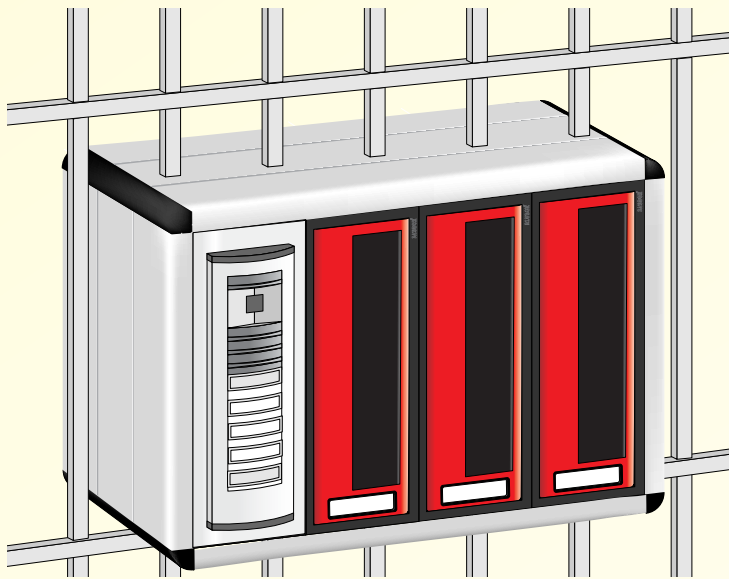
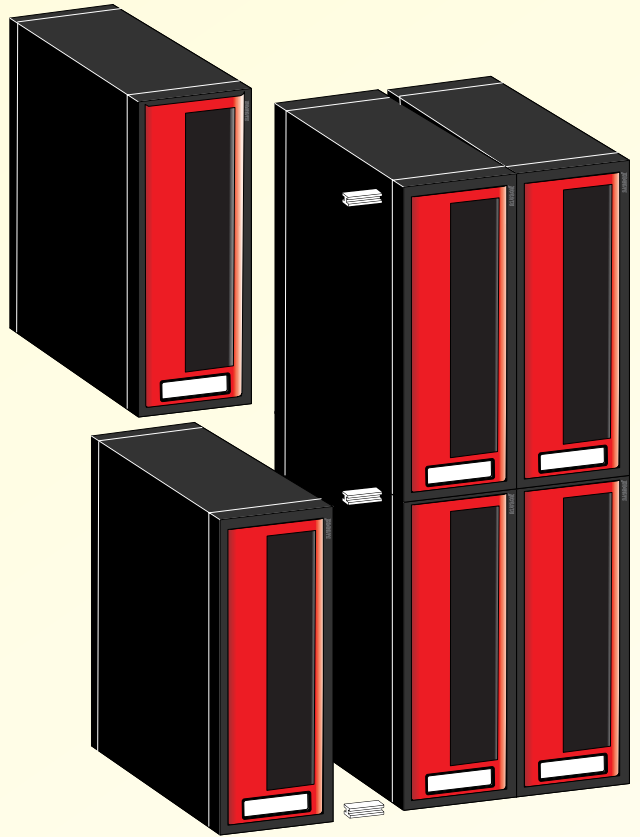
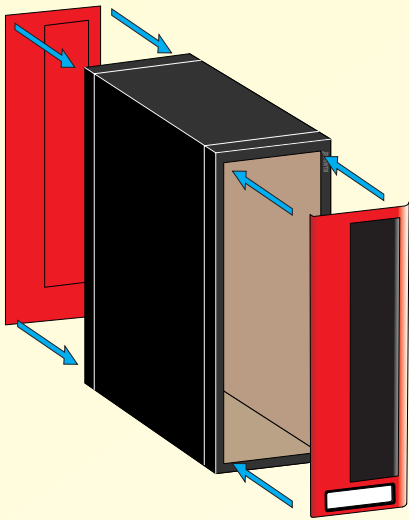

Composizione con mantello da recinzione
Set with outer casing for fence mounting

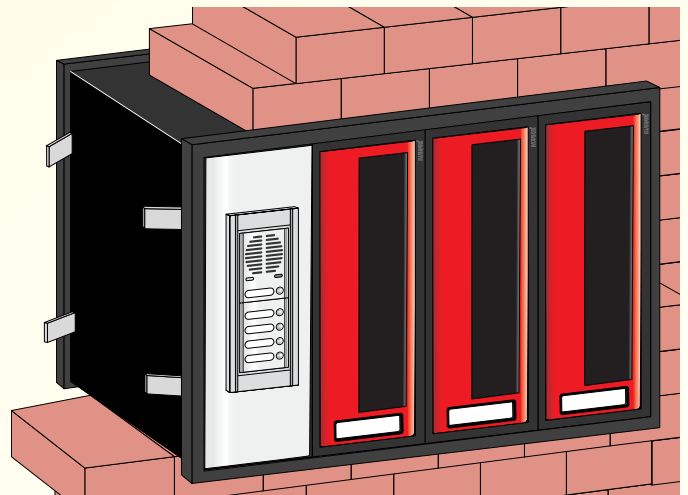

Composizione da incasso con cornice
Recess mounting set with frame

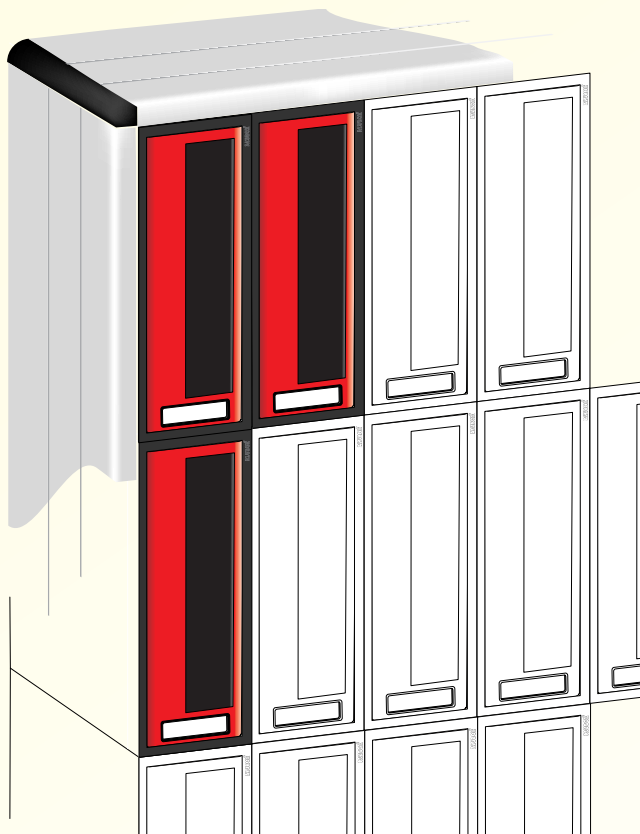

Serie MODULAR 2 verticale

RIVISTA

INTERNO

ESTERNO
con mantello

INCASSO

COMPONIBILE

Made in Italy



Modular 2V Completa
Modular 2V Complete set



SPORTELLO MODULAR SP2VF

(confezione 6 pezzi)

Sportello universale per Modular C2, completo di elemento mobile.

In profilato d'alluminio:

- anodizzato argento
- anodizzato bronzo
- verniciato nero
- verniciato rosso RAL 3003 con elemento mobile nero
- verniciato verde RAL 6005 con elemento mobile nero
- verniciato bianco RAL 9016 con elemento mobile nero
- verniciato ghisa con elemento mobile nero



SP2VR

- sportello retro finiture come per SP2VF

Tutta la Serie MODULAR viene fornita con corpo e sportelli smontati.

DOOR MODULAR SP2VF

(6-pc package)

Universal door for Modular C2, complete with flap. In aluminium, available in the following finishes:

- anodised silver
- anodised bronze
- painted in black
- painted in RAL 3003 red with black flap
- painted in RAL 6005 green with black flap
- painted in RAL 9016 white
- painted cast-iron grey with black flap

SP2VR

- rear door with same finishes SP2VF

The entire MODULAR series is supplied with body and doors not assembled.

Accessori per citofoni, campanelli e videocitofoni da pagina M22.

Accessories for intercoms, doorbells and video telephone entry systems, see from page M22.

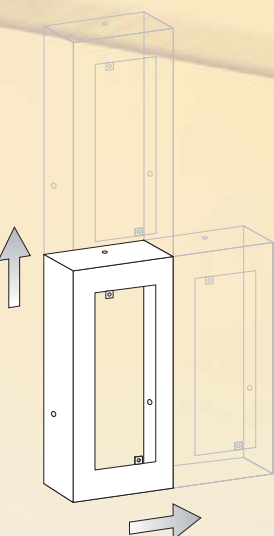

Placca porta accessori
Accessories holding plate



MODULAR C2

(confezione da 6 pezzi)

Corpo cassetta componibile bifrontale da incasso passante, in **alluminio** elettro colore testa di moro.

MODULAR C2

(6-pc package)

Body for double-sided mailbox for wall mounting in dark brown **anodised aluminium**.

MODULAR C2F

Corpo cassetta componibile bifrontale da incasso passante, in **lamiera elettrozincata**.

MODULAR C2F

Body for double-sided mailbox for wall mounting in **electrogalvanised sheet steel**.



SP2VR - Retro - Rear door



SP2VF - Frontale - Front door

Come assemblare la MODULAR 2T

How to assemble MODULAR 2T

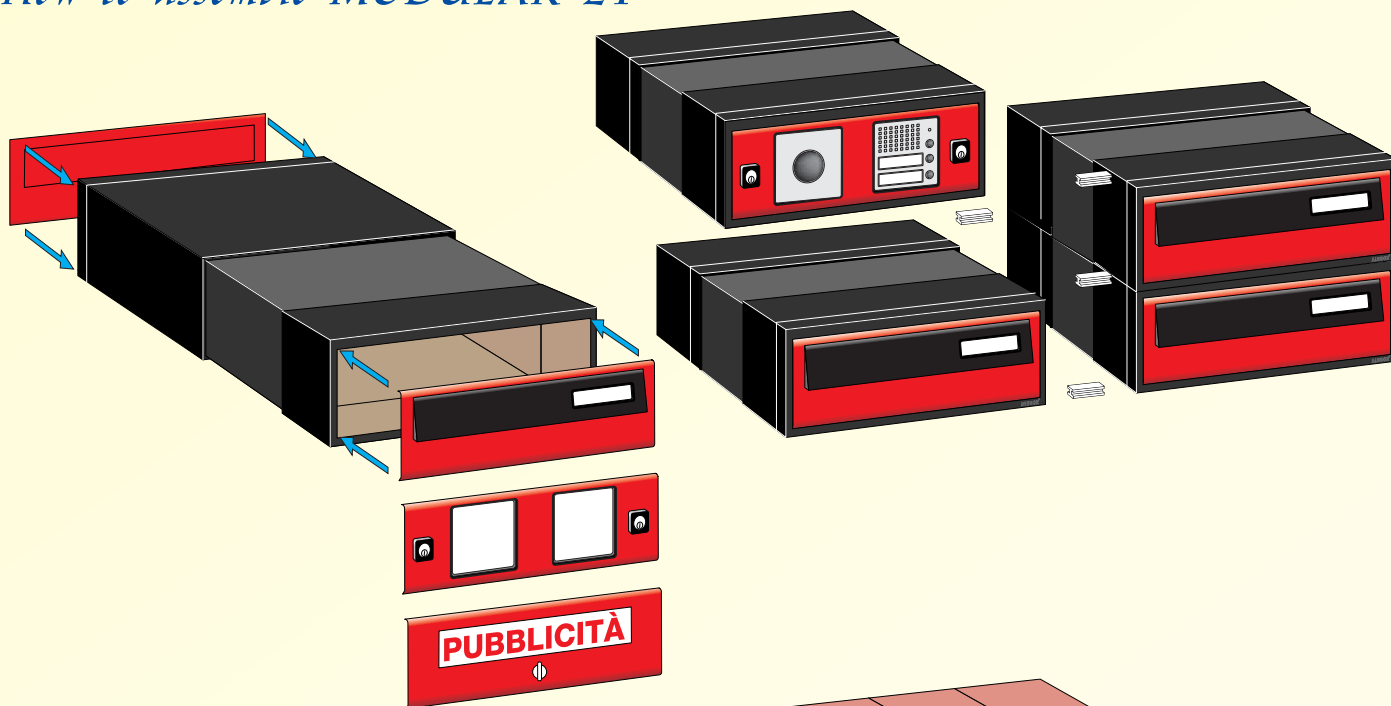

Composizione da incasso
con cornice coprifuga
Recess mounting set with
cover frame

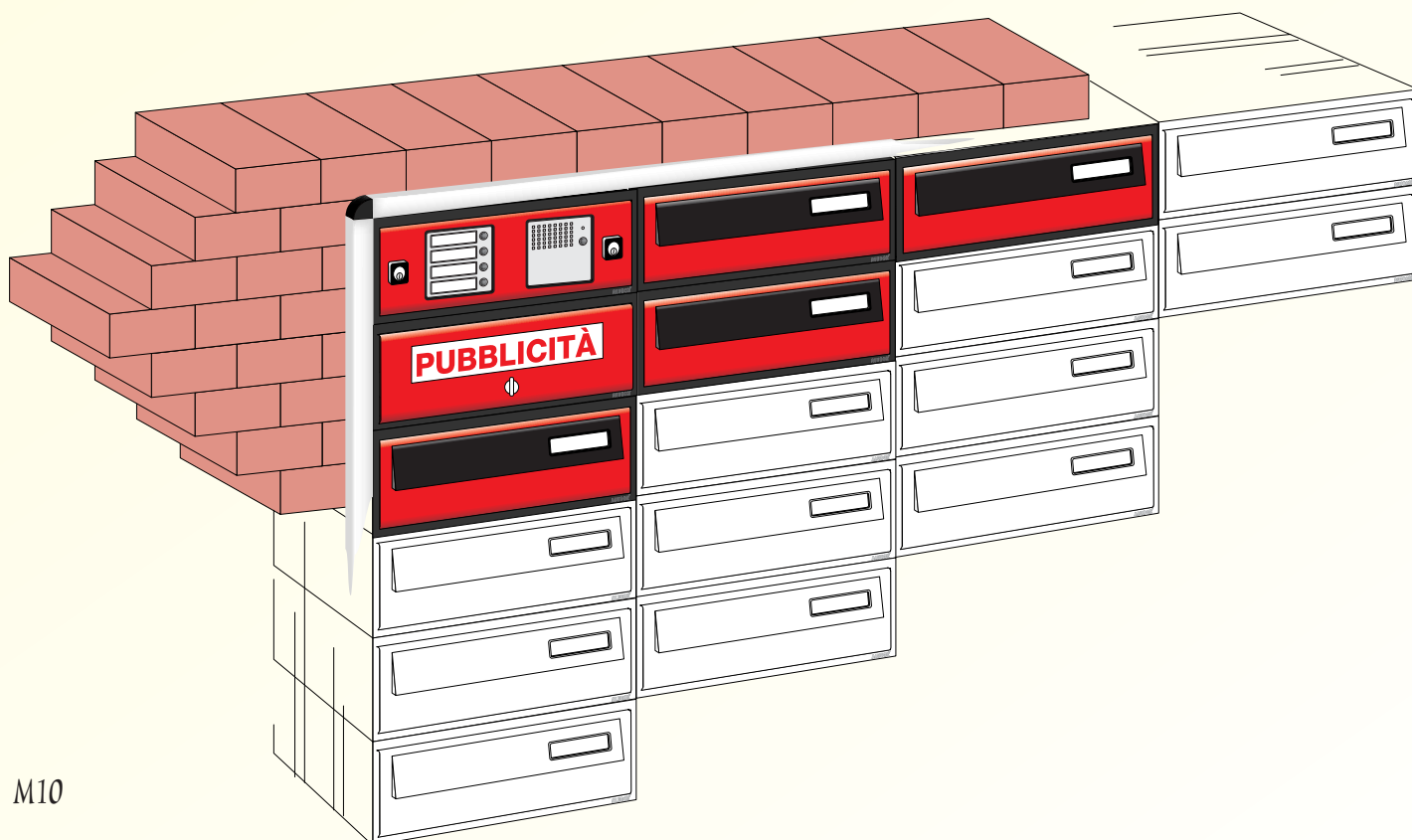
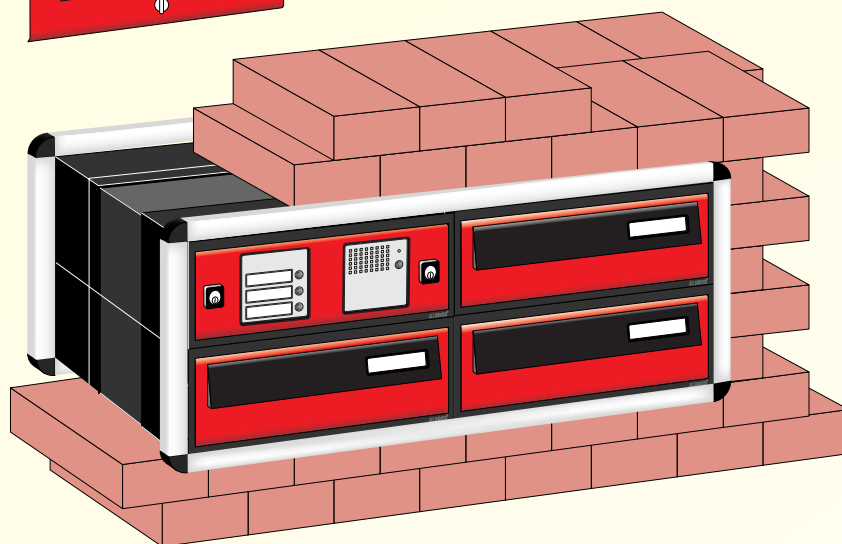

RIVISTA

INTERNO

ESTERNO

INCASSO

COMPONIBILE

Made in Italy

MODELLO CONFORME NORME EUROPEE

EN 13724



SPORTELLO MODULAR 2T

(confezione 6 pezzi)

Sportello universale per Modular 2T, completo di elemento mobile. In profilato d'alluminio:

- anodizzato argento
- anodizzato bronzo
- verniciato nero
- verniciato rosso RAL 3003 con elemento mobile nero
- verniciato verde RAL 6005 con elemento mobile nero
- verniciato bianco RAL 9016 con elemento mobile nero
- verniciato ghisa con elemento mobile nero

Tutta la Serie MODULAR viene fornita con corpo e sportelli smontati.

DOOR MODULAR 2T

(6-pc package)

Universal door for Modular 2T, complete with flap. In aluminium, available in the following finishes:

- anodised silver
- anodised bronze
- painted in black
- painted in RAL 3003 red with black flap
- painted in RAL 6005 green with black flap
- painted in RAL 9016 white
- painted cast-iron grey with black flap

The entire MODULAR series is supplied with body and doors not assembled.

Sportello SP - OTT

Sportello in alluminio con elemento mobile in ottone.

Door SP - OTT

Aluminium door with brass flap.



MODULAR 2T + SP1 PUB

(confezione da 1 pezzo)

Corpo completo di sportello per pubblicità.

MODULAR 2T + SP1 PUB

(1-pc-package)

Body complete with adhesive name plate for advertising.



Modular 2 T Completa
Modular 2 T Complete set

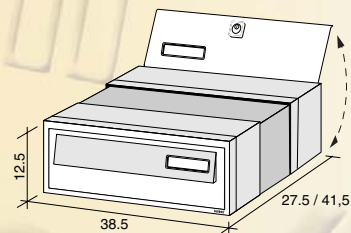

MODULAR 2 ACC

Cassetta completa bifrontale da incasso passante, in alluminio elettro colore testa di moro e sportello porta accessori predisposto per l'inserimento di campanelli, telecamera, citofono e numero civico per i modelli Terraneo Sfera. Altri modelli vedi da pag. M22. **Finiture: vedi sportello Modular 2T**

MODULAR 2 ACC

Complete through mounting double-sided mailbox, in dark black oxi-anodised aluminium and accessories holding door designed for incorporating doorbells, video camera, intercom and residence number for models Terraneo Sfera. Other models, see from page M22. **Types of Finish: see Modular 2T door**



Modular Telescopica:

cassetta bifrontale da incasso con corpo a profondità variabile: da un minimo di cm 27,5 a un massimo di cm 43 di spessore del muro.

Modular Telescopica:

two-sided recess mounted mail box with body of varying depth suitable for a wall depth ranging from 27.5 cm to 43 cm.

Come assemblare la MODULAR 270

How to assemble MODULAR 270

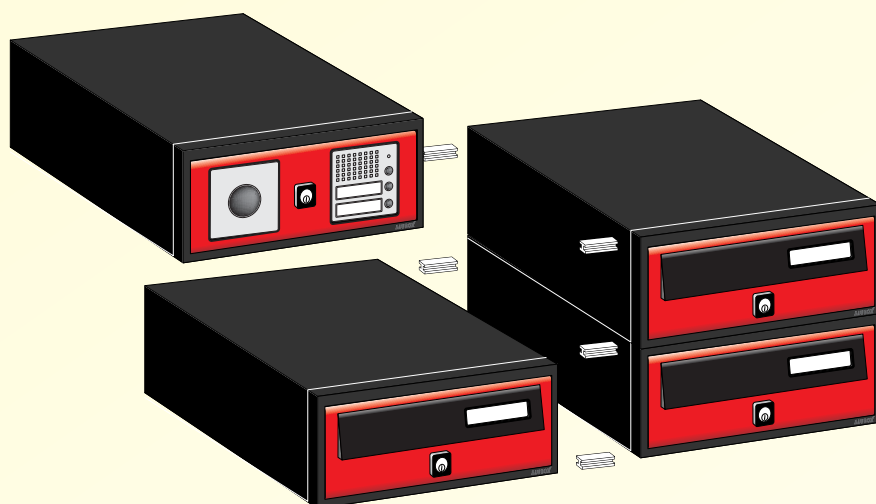
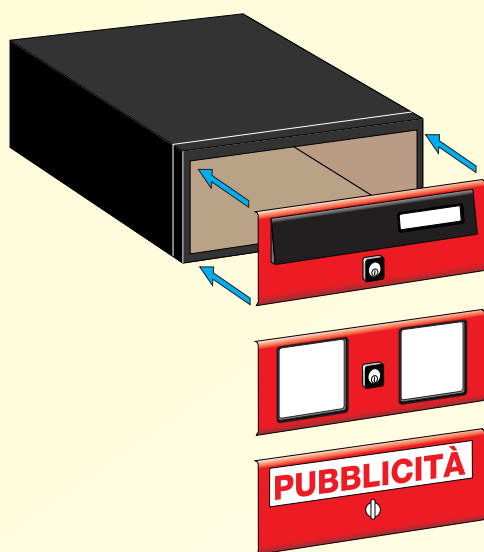

Composizione con mantello
Set with outer casing

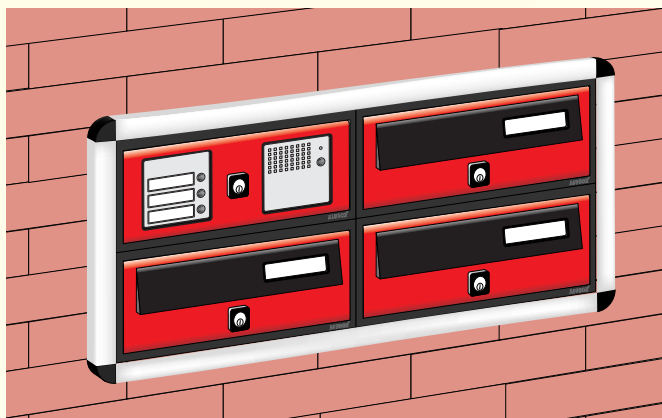

Composizione da incasso con cornice coprifuga
Recess mounting set with cover frame

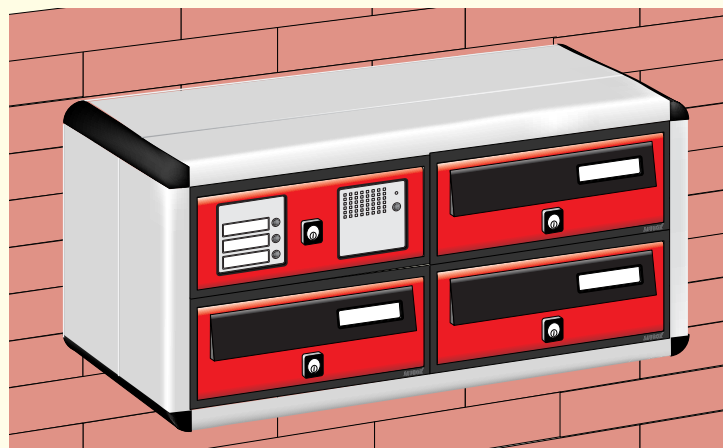

Composizione semincasso con mantello
Set with outer casing for semi-recess mounting





MODULAR SP1/270

(confezione 6 pezzi)

Sportello universale per Modular 270 completo di elemento mobile.

In profilato d'alluminio.

- anodizzato argento
- anodizzato bronzo
- verniciato nero
- verniciato rosso RAL 3003 con elemento mobile nero
- verniciato verde RAL 6005 con elemento mobile nero
- verniciato bianco RAL 9016
- verniciato ghisa con elemento mobile nero



Sportello SP - OTT

Sportello in alluminio con elemento mobile in ottone.

Door SP - OTT

Aluminium door with brass flap.



SP1 ACC/270

Sportello Serie MODULAR 270 in profilato d'alluminio predisposto per l'inserimento di campanelli, telecamera, citofono e numero civico per i modelli Terraneo Sfera. Altri modelli vedi da pag. M22.

Finiture: vedi sportello Modular SP1/270

SP1 ACC/270

MODULAR 270 series door in aluminium profile designed for incorporating doorbells, video camera, intercom and residence number for models Terraneo Sfera. Other models, see from page M22.

Types of Finish: see Modular SP1/270 door

Tutta la Serie MODULAR viene fornita con corpo e sportelli smontati.

MODULAR SP1/270

(6-pc package)

Universal door for Modular 270.

Complete with flap, made of aluminium.

- anodised silver
- anodised bronze
- painted in black
- painted in RAL 3003 red with black flap
- painted in RAL 6005 green with black flap
- painted in RAL 9016 white
- painted cast-iron grey with black flap

The entire MODULAR series is supplied with body and doors not assembled.



MODULAR C270

per SP1/270 e SP1 ACC/270

(confezione da 6 pezzi)

Corpo per cassetta componibile in **alluminio** elettro colore testa di moro.

MODULAR C270

for SP1/270 and SP1 ACC /270

(6-pc package)

Body for modular mailbox in dark brown-black anodised **aluminium**.

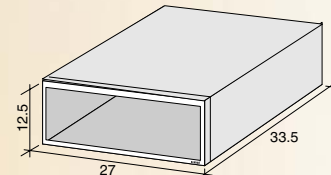

Modular 270
Completa
Modular 270
Complete set

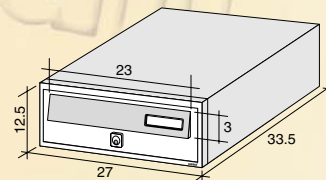

CORPO MODULAR C270 + SP1 PUB

(confezione da 1 pezzo)

Corpo completo di sportello per cassetta doppia porta pubblicità.

BODY FOR MODULAR C270 + SP1 PUB

(confezione da 1 pezzo)

Double body complete with adhesive name plate for advertising.

CORPO MODULAR C270 + SP1 PUB

(confezione da 1 pezzo)

Corpo completo di sportello per cassetta singola porta pubblicità.

BODY FOR MODULAR C270 + SP1 PUB

(confezione da 1 pezzo)

Body complete with flap for adhesive name plate for advertising.

Modello con profondità maggiore e larghezza inferiore rispetto alla Modular 1 e Modular 2 per consentire di utilizzare spazi ridotti.

Model with greater depth and narrower width than Modular 1 and Modular 2 in order to use smaller areas.

Come assemblare la MODULAR 270/2

How to assemble MODULAR 270/2

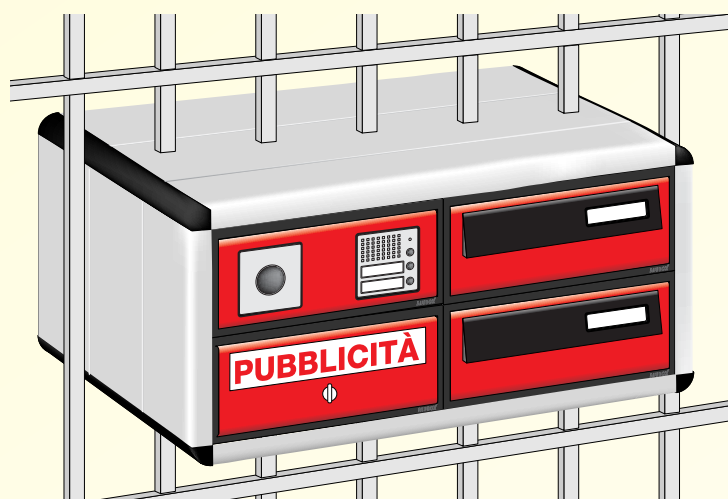
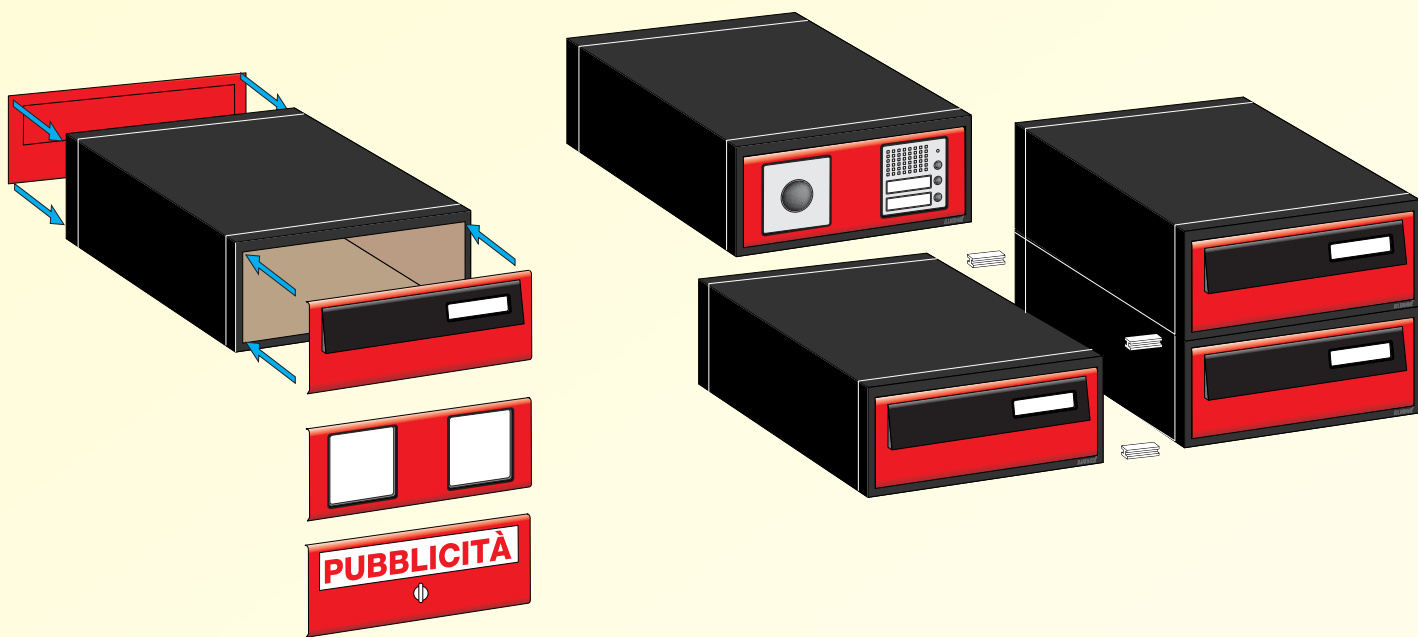

Composizione con mantello da recinzione
Set with outer casing for fence mounting

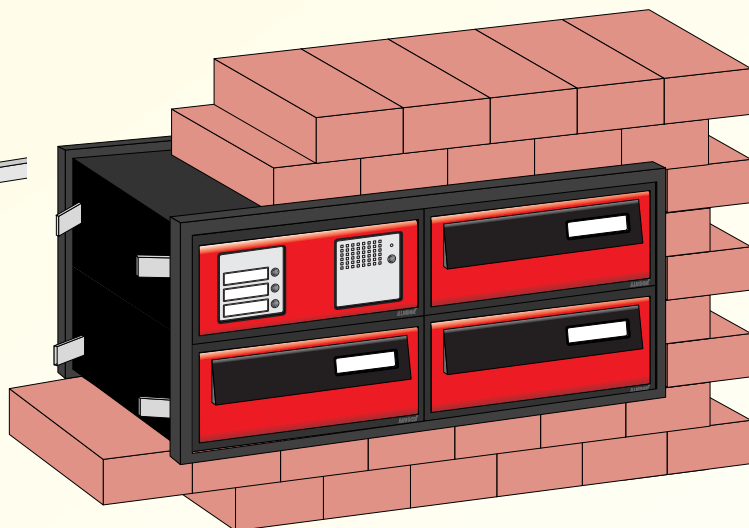

Composizione da incasso con cornice
Recess mounting set with frame



INTERNO

ESTERNO
con mantello

INCASSO

COMPONIBILE

Made in Italy

MODELLO CONFORME NORME EUROPEE

EN 13724

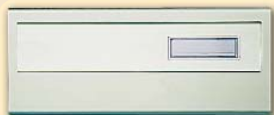
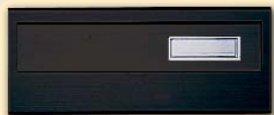

Sportello SP - OTT

Sportello in alluminio con elemento mobile in ottone.

Door SP - OTT

Aluminium door with brass flap.



SP1 ACC/270

Sportello Serie MODULAR 270 in profilato d'alluminio predisposto per l'inserimento di campanelli, telecamera, citofono e numero civico per i modelli Terraneo Sfera.

Altri modelli vedi da pag. M22.

Finiture: vedi sportello Modular SP270/2F

SP1 ACC/270

MODULAR 270 series door in aluminium profile designed for incorporating doorbells, video camera, intercom and residence number for models Terraneo Sfera. Other models, see from page M22. **Types of Finish: see Modular SP270/2F door**

MODULAR SP2 F/270

(confezione 6 pezzi)

Sportello universale per Modular 270/2 completo di elemento mobile. In profilato d'alluminio.

- anodizzato argento
- anodizzato bronzo
- verniciato nero
- verniciato rosso RAL 3003 con elemento mobile nero
- verniciato verde RAL 6005 con elemento mobile nero
- verniciato bianco RAL 9016
- verniciato ghisa con elemento mobile nero

SP2 R/270

- sportello retro finiture come per SP270

Tutta la Serie MODULAR viene fornita con corpo e sportelli smontati.

MODULAR SP2 F/270

(6-pc package)

Universal door for Modular 270/2.

Complete with flap, made of aluminium.

- anodised silver
- anodised bronze
- painted in black
- painted in RAL 3003 red with black flap
- painted in RAL 6005 green with black flap
- painted in RAL 9016 white
- painted cast-iron grey with black flap

SP2 R/270

- rear door with same finishes SP270

The entire MODULAR series is supplied with body and doors not assembled.



CORPO MODULAR C270/2 + SP1 PUB

(confezione da 1 pezzo)

Corpo doppio completo di sportello per pubblicità.

BODY FOR MODULAR C270/2 + SP1 PUB

(1-pc package)

Double body complete with adhesive name plate for advertising.

CORPO MODULAR C270/2 + SP1 PUB

(confezione da 1 pezzo)

Corpo completo di sportello per pubblicità.

BODY FOR MODULAR C270/2 + SP1 PUB

(1-pc package)

Body complete with adhesive name plate for advertising.

Modello con profondità maggiore e larghezza inferiore rispetto alla Modular 1 e Modular 2 per consentire di utilizzare spazi ridotti.

Model with greater depth and narrower width than Modular 1 and Modular 2 in order to use smaller areas.



MODULAR C270/2

per SP1/270 e SP1 ACC/270

(confezione da 6 pezzi)

Corpo per cassetta componibile in alluminio elettro colore testa di moro.

MODULAR C270/2

for SP1/270 and SP1 ACC /270

(6-pc package)

Body for modular mailbox in dark brown-black anodised aluminium.

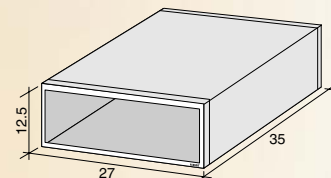

SP270/2F - Frontale - Front door

Modular 270/2
Completa
Modular 270/2
Complete set



SP270/2R - Retro - Rear door

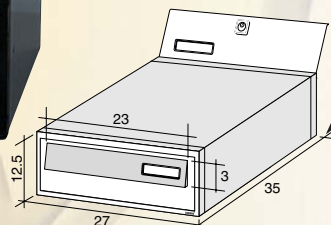

Come assemblare la MODULAR 3

How to assemble MODULAR 3

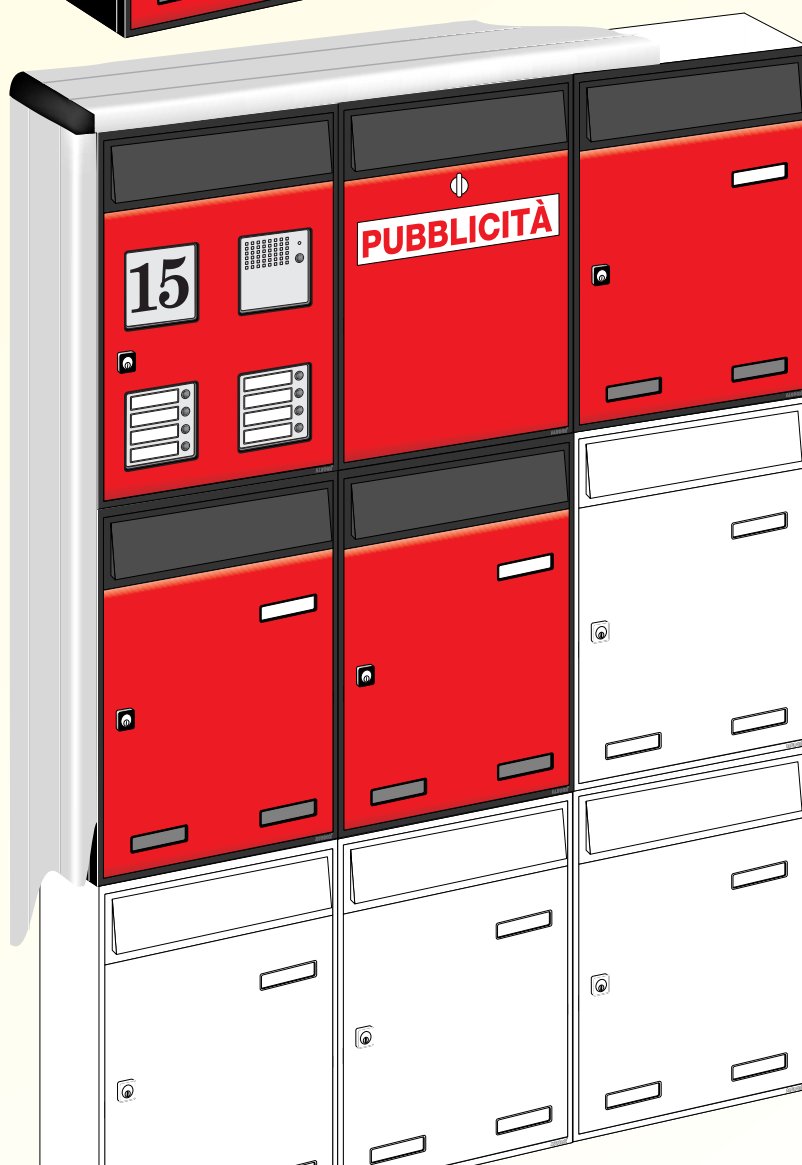
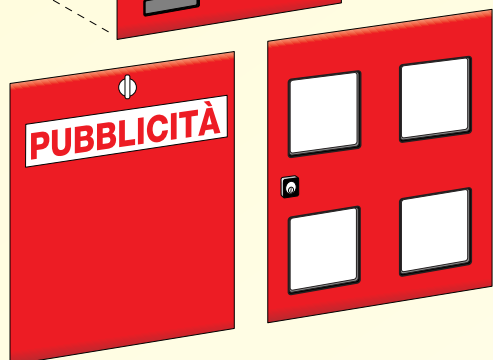
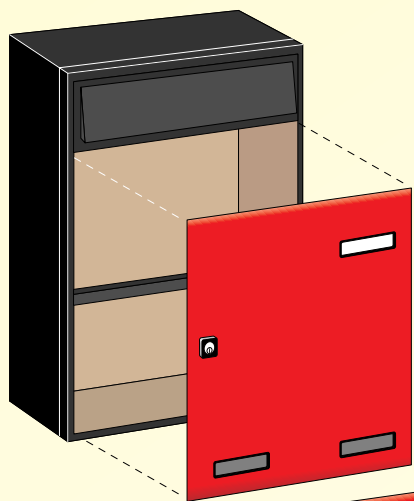

Composizione con mantello
Set with outer casing

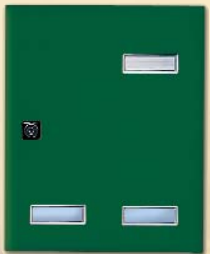

Sportello MODULAR SP3

(confezione 6 pezzi)

Sportello per Modular C3 in alluminio:

- Anodizzato argento
- Anodizzato bronzo
- Verniciato nero
- Verniciato bianco Ral 9016
- Verniciato verde Ral 6005
- Verniciato rosso Ral 3003
- Verniciato ghisa

Tutta la Serie MODULAR viene fornita con corpo e sportelli smontati.

Door MODULAR SP3

(6-pc package)

Door for Modular C3 in aluminium:

- Anodised silver
- Anodised bronze
- Painted in black
- Painted in white Ral 9016
- Painted in green Ral 6005
- Painted in red Ral 3003
- Painted cast-iron grey

The entire MODULAR series is supplied with body and doors not assembled.

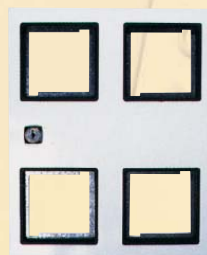

SP3 ACC

Sportello in alluminio porta accessori per campanelli, telecamera e numero civico per i modelli Terraneo Tersystem o Sfera. Altri modelli vedid a pag. M22.

Finiture: vedi Modular SP3

SP3 ACC

Aluminium door suitable for holding door-bells, video camera and residence number, for models Terraneo Tersystem or Sfera. Other models, see from page M22.

Types of Finish: see Modular SP3



AM3

Kit antivandalo con chiusura in tre punti per modello SP3.

AM3

Burglar-proof kit with three-point lock for Modular SP3.

SP3 PUB

Sportello SP3 con KITPUB

SP3 PUB

Door SP3 whit KITPUB



Modular 3 Completa
Modular 3 Complete set

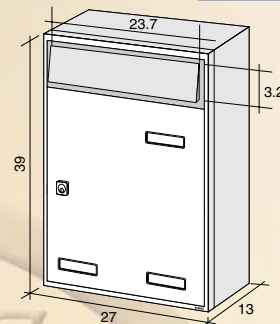

MODULAR C3

(confezione 6 pezzi)

Corpo per cassetta componibile in **alluminio** testa di moro completo di elemento mobile in profilato d'alluminio anodizzato nero e dell'anti-prelievo.

MODULAR C3

(6-pc package)

Body for Modular mailbox in dark brown **aluminium** complete with anodised dark brown flap and burglar-proof system.

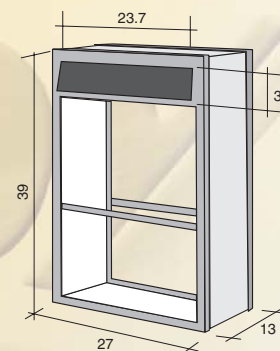

MODULAR C3/2

(confezione 6 pezzi)

Corpo per cassetta passante componibile in **alluminio** testa di moro completo di elemento mobile in profilato d'alluminio anodizzato nero e dell'antiprelievo.

MODULAR C3/2

(6-pc package)

two-sided mail box body

Modular mailbox in dark brown **aluminium** complete with anodised dark brown flap and burglar-proof system.



Retro

Modular 3/2 Completa
Modular 3/2 Complete set

Accessori-Accessories MODULAR ● PIANTANE - SUPPORT COLUMNS

Piantane in alluminio verniciato per blocchiere con mantello.
Support Aluminium in stainless steel for mail boxes sets with casing.

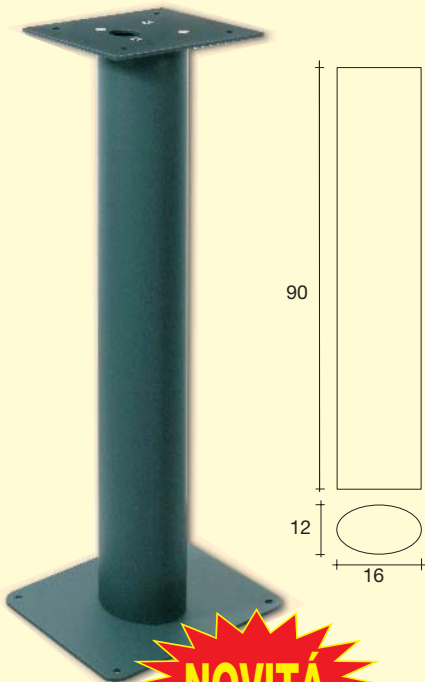

NOVITÀ

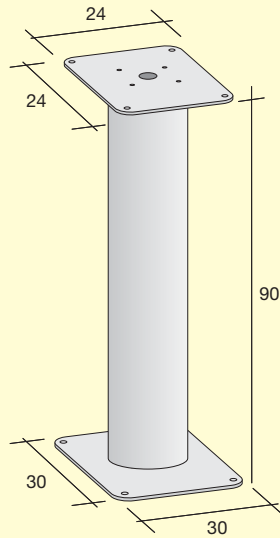

Piantana con piastra piccola.
Support column with small plate.

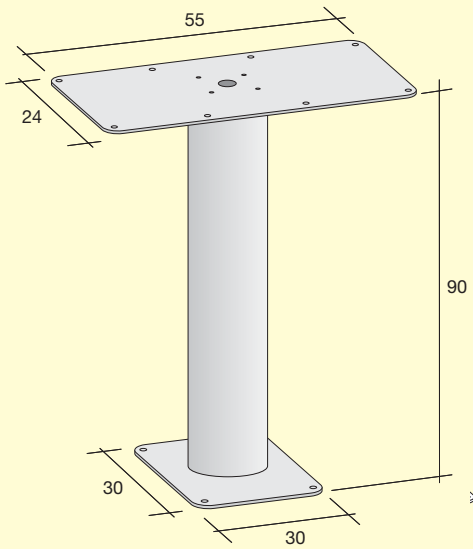
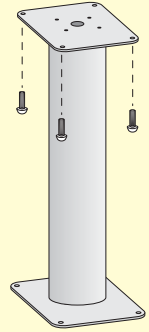
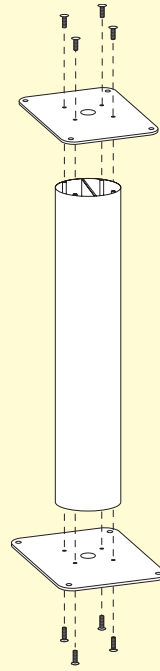

Piantana con piastra grande.
Support column with big plate.

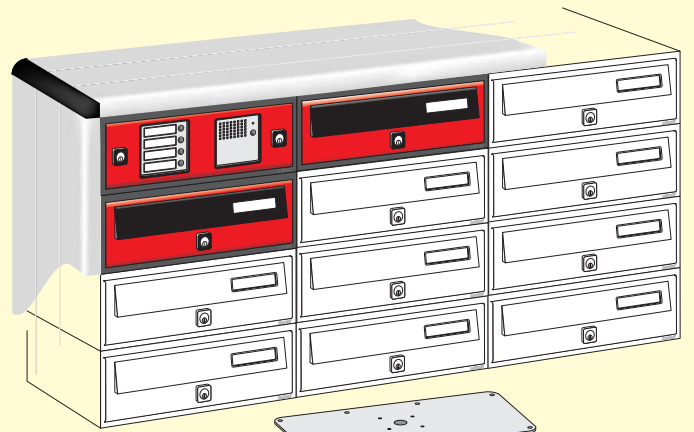
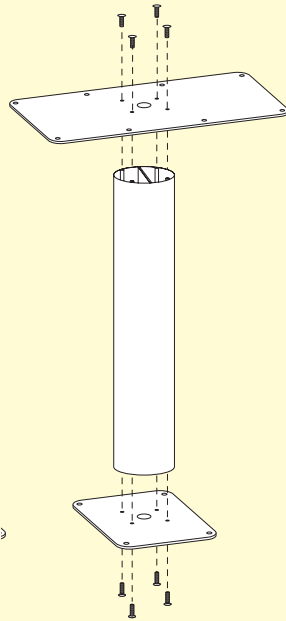

Esempio di blocchiera MODULAR
assemblata con mantello e piantana

Example of MODULAR unit assem-
bled with casing and support
column

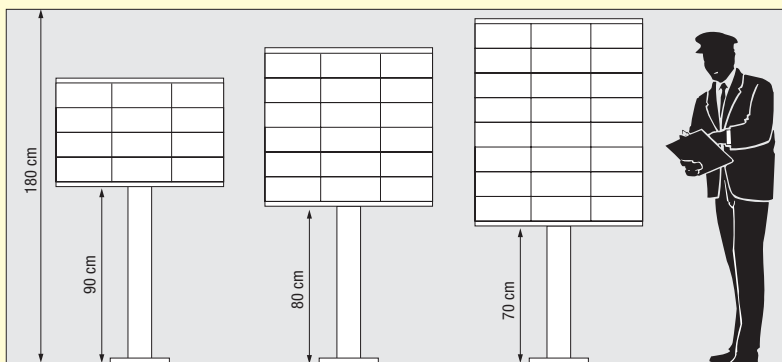
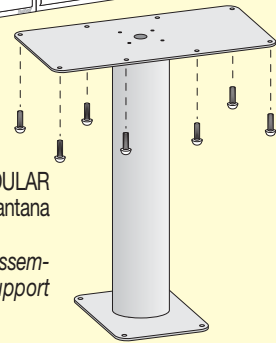

Esempi di possibili altezze delle blocchiere MODULAR
assemblate con palo.

Example of possible heights of MODULAR mailbox sets
assembled with post.

Fino ad un massimo di 6 cassette in altezza,
piantana standard di cm 90.

Up to a maximum assembly of vertical 6 mail-
boxes, 90 cm standard pedestal.

Prolungamento del mantello - *Extension of the casing*

Doppia piantana in alluminio per blocchiera Modular 3 con mantello
Doble support column for Modular 3 mail box units with casing.

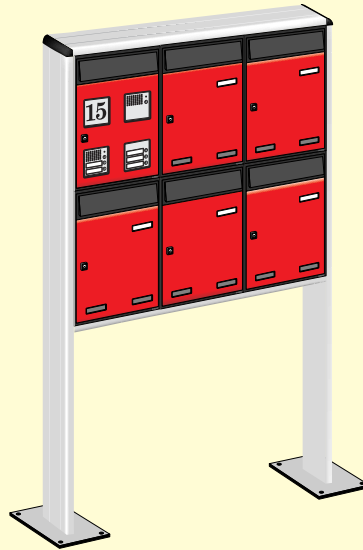
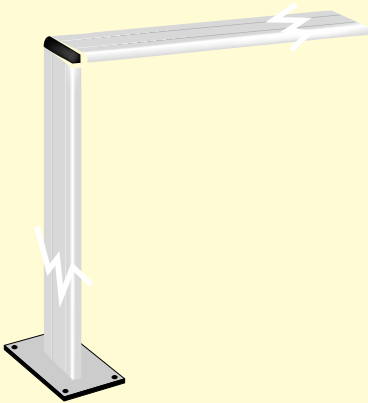

Esempio di blocchiera MODULAR 3 assemblata con mantello composta da 6 cassette postali di cui una con sportello accessorio di citofono, 5 campanelli, numero civico, completa di piantane.

Example of MODULAR 3 free standing mail boxes unit with outer casing composed by: 5 mail boxes and one accessory panel for intercom, doorbells and residence number plate, complete with support columns.

MANTELLO - CASING

Esempio di blocchiera MODULAR assemblata con mantello, composta da più cassette postali e sportello accessori.

Example of a MODULAR unit assembled with casing, composed by mail boxes and accessory panel for intercom and doorbells.

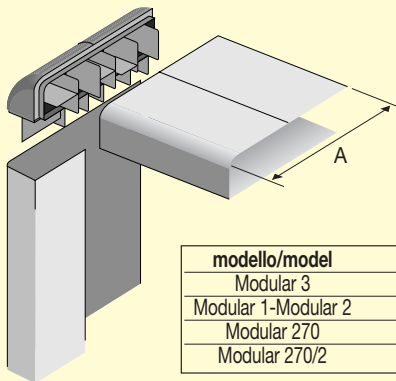

modello/model	A
Modular 3	150 mm
Modular 1-Modular 2	300 mm
Modular 270	350 mm
Modular 270/2	400 mm

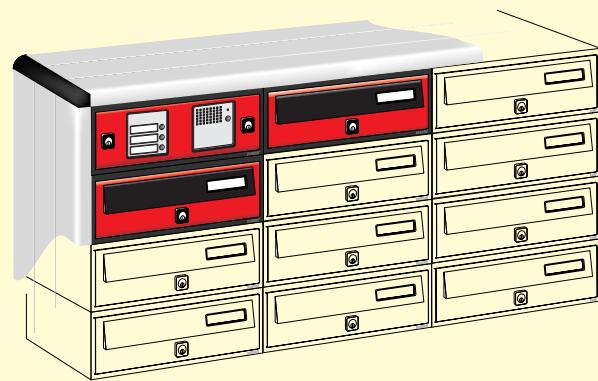

Mantello in profilato d'alluminio disponibile nei colori:

- anodizzato argento
- verniciato nero
- verniciato ghisa
- verniciato verde RAL 6005
- verniciato bianco RAL 9016
- verniciato rosso RAL 3003

Casing in aluminium available in the following colours:

- *anodised silver*
- *painted in black*
- *painted cast-iron grey*
- *painted in RAL 6005 green*
- *painted in RAL 9016 white*
- *painted in RAL 3003 red*

CORNICE - FRAME

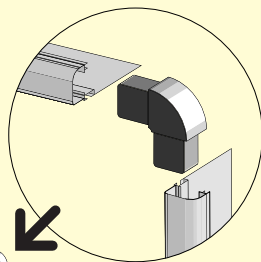

CORNICE COPRIFUGA
 Cornice in profilato d'alluminio anodizzato argento o verniciato ghisa e nero, completa di angoli.

Frame in aluminium section, anodised silver or painted cast iron grey and black colour with corners.

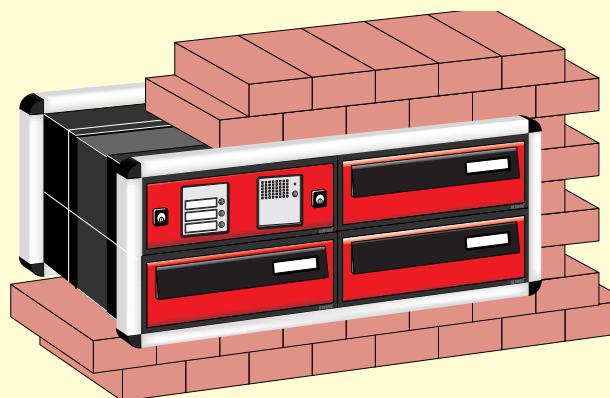
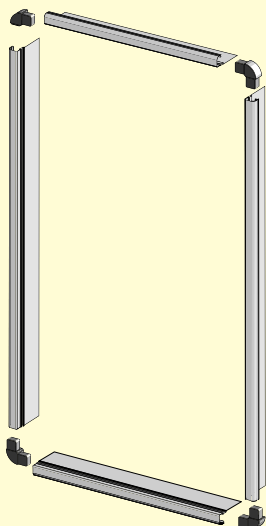

Esempio di blocchiera Modular 2T composta da 3 cassette postali ed una con sportello accessorio di citofono e 3 camapnelli incassata nel muro e assemblata con cornice fronte e retro.

Example of a Modular 2T mail box unit composed by: 3 mail boxes and one accessory panel for intercom and 3 doorbells, recess mounting set with front and rear frame.

Bticino SFERA

predisposizione
predisposition

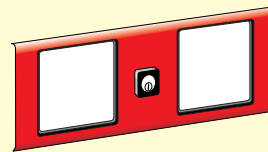
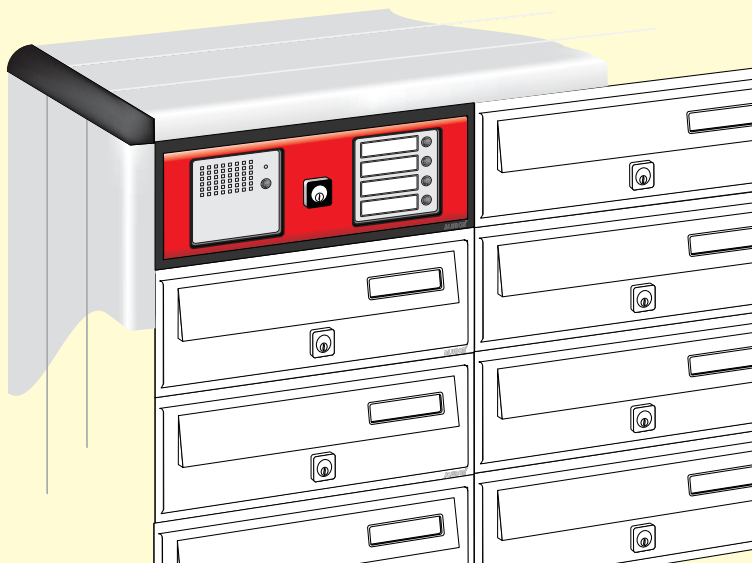

SP ACC SF
Sportello porta
accessori per sfera



332911
modulo = cieco
module = blind



332231
modulo = 3 pulsanti
module = 3 pushes



332201
modulo = n° civico
module = residence number

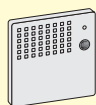

332101
modulo = citofono
module = intercom

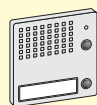

332111
modulo = citofono + 1 pulsante
module = intercom + 1 push



332121
modulo = citofono + 2 pulsanti
module = intercom + 2 pushes

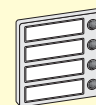

332241
modulo = 4 pulsanti
module = 4 pushes

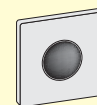

332501
modulo = telecamera
module = camera



Esempio con sportello porta accessori
Example of MODULAR unit assembled with camera, intercom and balls

Bticino SFERA

predisposizione
predisposition

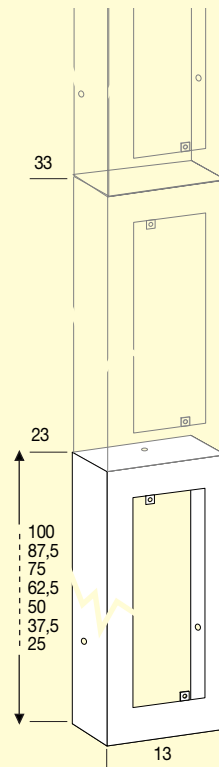

Placca porta accessori

Accessories holding plate

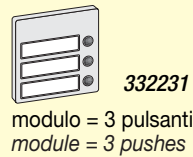
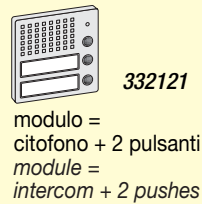
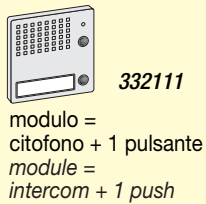
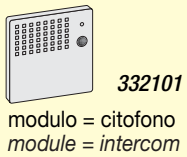

23,3

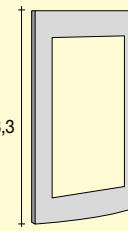

331221

Telaio porta moduli SFERA da 2 moduli
SFERA module holding frame for 2 modules

32,5

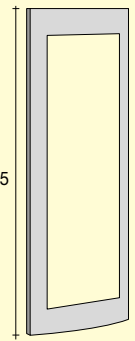

331231

Telaio porta moduli SFERA da 3 moduli
SFERA module holding frame for 3 modules

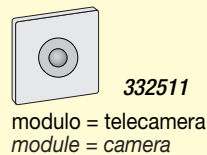
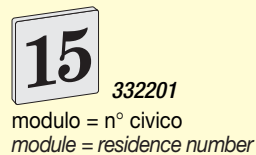
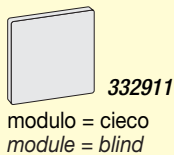
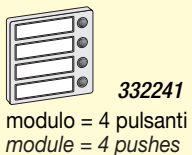

Placca Portaccessori disponibile nei colori anodizzato argento e bronzo o verniciato rosso, verde, bianco, ghisa e nero

Slot plate available in the following colours: Anodized silver and bronze, or painted in red, green, white and cast-iron grey and black

Esempio con placca porta accessori
Example of MODULAR unit assembled with camera, intercom and balls

Bticino MINISFERA

predisposizione
predisposition

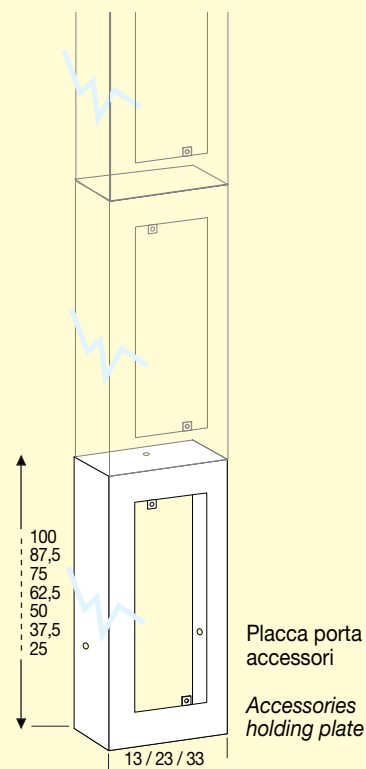
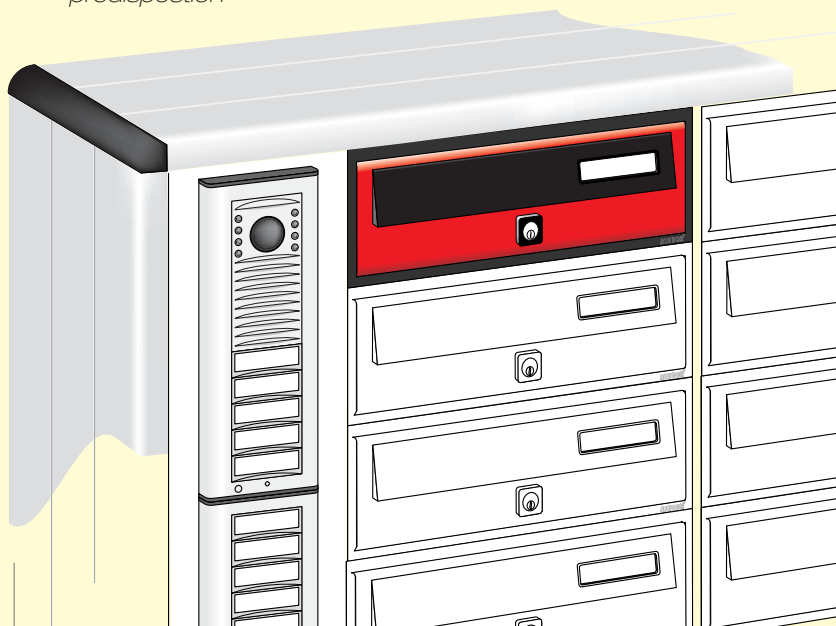

 **332712**
pulsante = 1 posto
bell push = 1 space

 **332713**
pulsante doppio = 2 posti
doble push = 2 spaces

 **332702**
citofono = 4 posti
intercom = 4 spaces

 **332714**
n° civico
= 2 posti
residence number
= 2 spaces

 **332715**
pulsante cieco
= 1 posto
bell push blind
= 1 space

 **332708**
telecamera + citofono
= 6 posti
camera + intercom
= 6 spaces

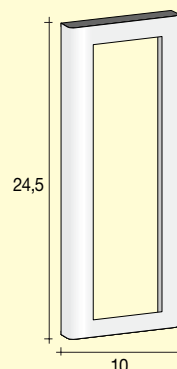
 **332721**
Telaio porta moduli
MINISFERA da 10 posti
MINISFERA module
holding frame
for 10 elements

24,5
10

Placca Portaccessori disponibile nei colori anodizzato argento e bronzo o verniciato rosso, verde, bianco, ghisa e nero
Slot plate available in the following colours: Anodized silver and bronze, or painted in red, green, white and cast-iron grey and black



BPT TARGHA

predisposizione
predisposition

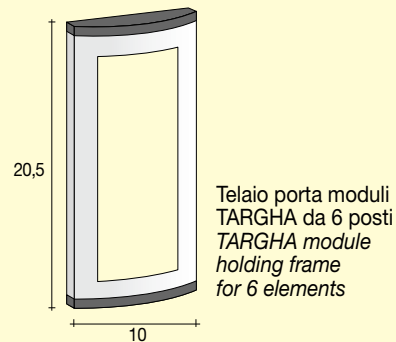
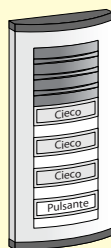
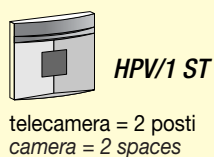
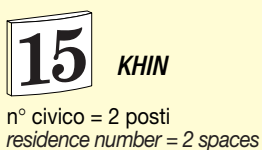
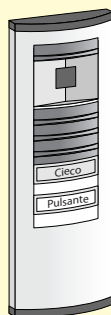
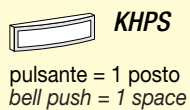
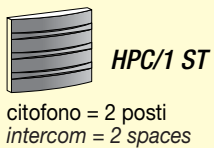
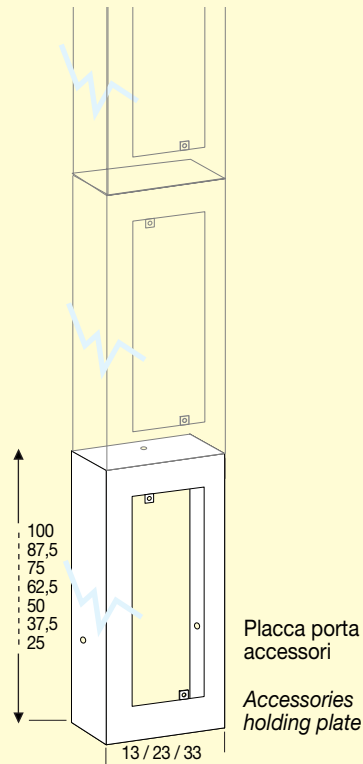

Placca Portaccessori disponibile nei colori anodizzato argento e bronzo o verniciato rosso, verde, bianco, ghisa e nero
Slot plate available in the following colours: Anodized silver and bronze, or painted in red, green, white and cast-iron grey and black



ELVOX GALILEO

predisposizione
predisposition

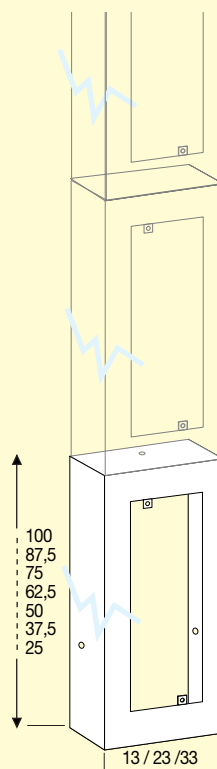
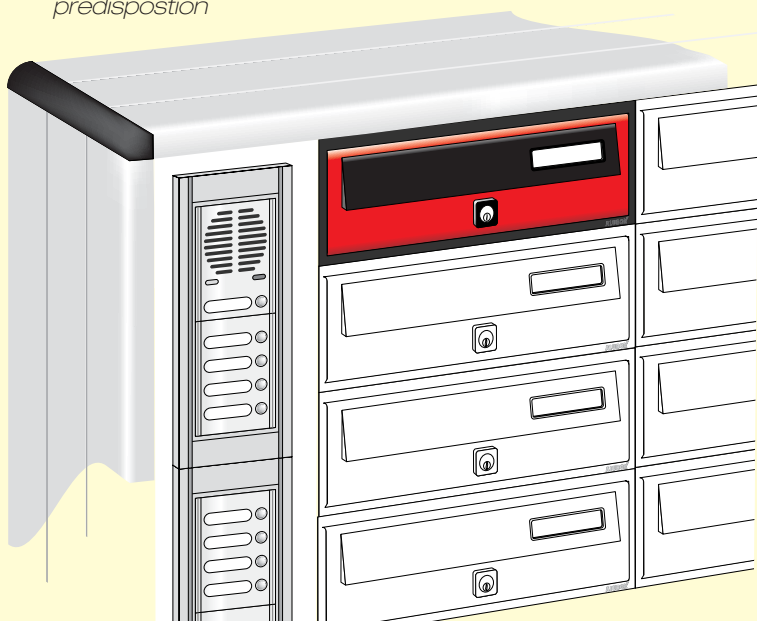

Placca porta accessori

Accessories holding plate

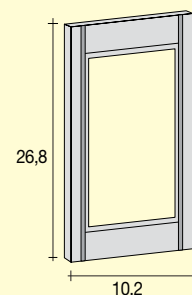

8082
Telaio porta moduli GALILEO da 2 moduli
GALILEO module holding frame for 2 modules.



8010
modulo = citofono
module = intercom



8011
modulo = citofono + 1 pulsante
module = intercom + 1 push

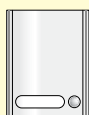

8001
modulo = 1 pulsante
module = 1 push

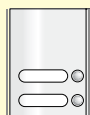

8002
modulo = 2 pulsanti
module = 2 pushes



8003
modulo = 3 pulsanti
module = 3 pushes



8004
modulo = 4 pulsanti
module = 4 pushes



8000
modulo = cieco
module = blind



800N
modulo = n° civico
module = residence number



8019
modulo = telecamera + citofono
module = camera + intercom

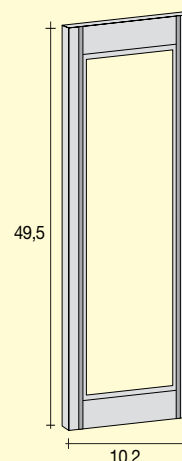

8084
Telaio porta moduli GALILEO da 4 moduli
GALILEO module holding frame for 4 modules.

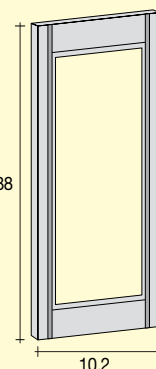

8083
Telaio porta moduli GALILEO da 3 moduli
GALILEO module holding frame for 3 modules.

Placca Portaccessori disponibile nei colori anodizzato argento e bronzo o verniciato rosso, verde, bianco, ghisa e nero
Slot plate available in the following colours: Anodized silver and bronze, or painted in red, green, white and cast-iron grey and black



URMET SINTHESI

predisposizione
pre-disposition

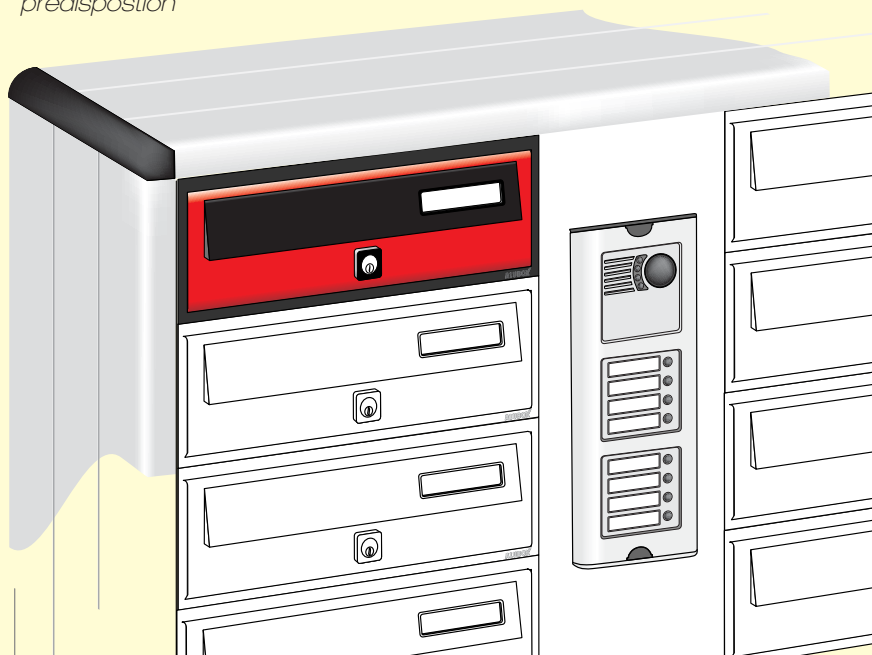

Placca porta accessori

Accessories holding plate

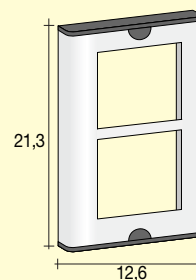
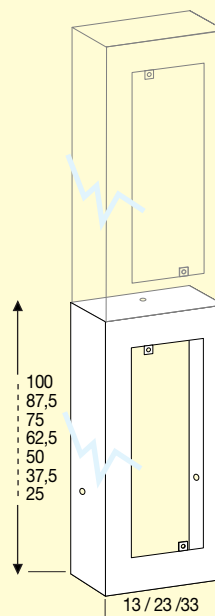

1145/62

Telaio porta moduli SINTHESI da 2 moduli
SINTHESI module holding frame for 2 modules

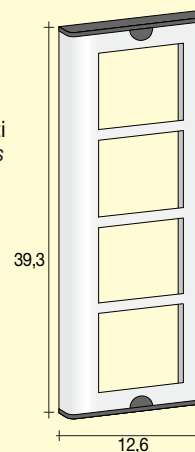

1145/64

Telaio porta moduli SINTHESI da 4 moduli
SINTHESI module holding frame for 4 modules

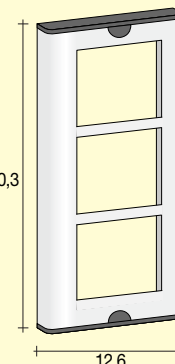

1145/63

Telaio porta moduli SINTHESI da 3 moduli
SINTHESI module holding frame for 3 modules



1145/20

modulo = citofono
module = intercom



1145/21

modulo = citofono + 1 pulsante
module = intercom + 1 pushes



1145/22

modulo = citofono + 2 pulsanti
module = intercom + 2 pushes



1145/11

modulo = 1 pulsante
module = 1 push

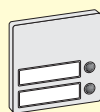

1145/12

modulo = 2 pulsanti
module = 2 pushes



1145/13

modulo = 3 pulsanti
module = 3 pushes



1145/14

modulo = 4 pulsanti
module = 4 pushes



1145/59

modulo = cieco
module = blind



1145/50

modulo = cieco
module = blind

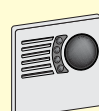

1745/80

modulo = videocitofono
module = camera + intercom

Placca Portaccessori disponibile nei colori anodizzato argento e bronzo o verniciato rosso, verde, bianco, ghisa e nero
Slot plate available in the following colours: Anodized silver and bronze, or painted in red, green, white and cast-iron grey and black





Esempi di installazione
Examples of Installation



POST
BOY











SEMPRE
PIÙ COMPLETA



ACCESSORIATA
MINISFERA

SEMPRE
PIÙ MODULARE



ACCESSORIATA
ELVOX



MODULAR



ACCESSORIATA
BPT